

VisionSOM-8Mmini EM Radiation Test

Revision 1.1, 1/2022

Rev. 1.1

1/2022

© 2021 SoMLabs Sp. z o. o.

All Rights Reserved. No warranty of accuracy is given concerning the contents of the information contained in this publication. To the extent permitted by law no liability (including liability to any person by reason of negligence) will be accepted by SoMLabs Sp. z o. o., its subsidiaries or employees for any direct or indirect loss or damage caused by omissions from or inaccuracies in this document.

SoMLabs Sp. z o. o. reserves the right to change details in this publication without notice.



Document Revision History

| Revision | Date | Notes |
|----------|------------|------------------------------|
| 1.0 | 26.11.2021 | Initial |
| 1.1. | 26.01.2022 | Minor editorial improvements |
| | | |

Table of Contents

| | |
|---|----|
| Document Revision History | 1 |
| Table of Contents..... | 2 |
| 1. Introduction..... | 3 |
| 2. Tested hardware | 4 |
| 3. Test equipment | 5 |
| 3.1. Standard measurements devices | 5 |
| 3.2. Dedicated measurement items | 5 |
| 4. Measurement setup..... | 7 |
| 5. Test procedure..... | 8 |
| 6. Results | 10 |
| 6.1. Results for 30MHz-1GHz frequency range (quasi-peak)..... | 10 |
| 6.2. Results for 1-3GHz frequency range (average) | 11 |
| 6.3. Results for 1-3GHz frequency range (peak) | 12 |
| 6.4. Reference charts | 13 |
| 7. Summary..... | 14 |
| 8. Limitation on Liability..... | 14 |

1. Introduction

This document presents the VisionSOM-8Mmini family modules EM emission/radiation tests, held at the precompliance SoMLabs EMC test lab.

Performed tests checked compatibility of EUT with emission requirements defined in standard EN 55032 class B (CISPR 32) in simulated open space environment (OATS) with 3 meters antenna distance.

Full test consists of three emission measurements in X, Y and Z axes and recalculation of the results of the obtained measurements according to the formula included in EN 55032 (CISPR 32) standard.

2. Tested hardware

Test covered VisionSOM-8Mmini in two hardware configurations (as on pictures below):

SLS23MMQC_1x00C_0yGR_zzGE_qqq_r

SLS23MMQC_1x00C_512R_zzGE_qqq_r

Where:

x – means 6 or 8

y – means 1, 2 or 4

zz – means 08, 16 or 32

qqq – means 0SF or 1WB (if qqq=1WB, SoM is tested with RF module switched off)

r – means I or C

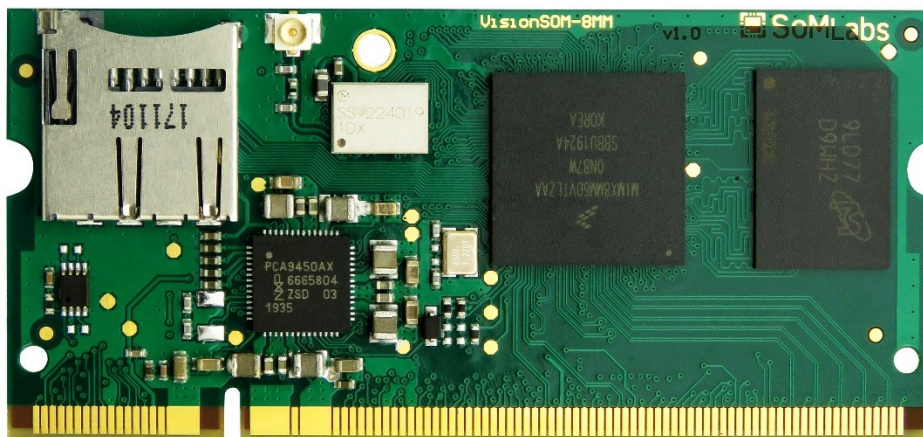

For testing purposes was prepared dedicated Linux system image with simple application using UART transmitters (*imx-image-multimedia-visionsom-8mm-cb* for eMMC memory and the same configuration and functionality, but optimized for MicroSD memory).

3. Test equipment

3.1. Standard measurements devices

| Test item | Radiated emission below 1GHz and 1-3GHz range | | | |
|---------------------|---|---------------------|------------|------------------|
| Instrument | Manufacturer | Model | Serial No. | Calibration date |
| Spectrum analyzer | Rohde & Schwarz | FPL1003 B22, K54 | 102103 | 12.2020 |
| GTEM chamber | Astat | GTEM250 | 1000007 | 3.2021 |
| Coaxial cable | Bruel & Kjaer | AO-0015 | 23621 | 5.2021 |
| Analog power supply | Korad | KA3005D | - | - |

3.2. Dedicated measurement items

For the correct performance of measurements, it was necessary to develop two dedicated elements:

- carrier board for SoM module with basic peripherals and power supply monitor,
- mechanical stand ensuring correct module positioning inside of GTEM chamber.

Dedicated carrier board (internally called YELLOW) with mounted SoM is shown on picture below.

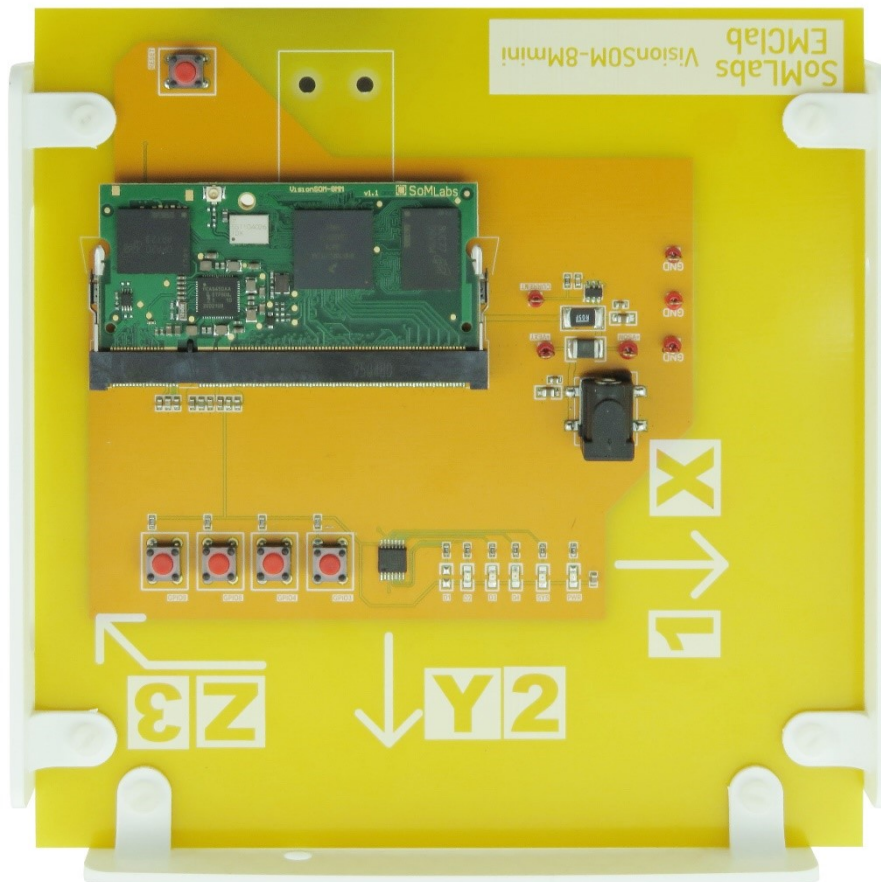

Because of testing method base on three emission measurements in X, Y and Z axes and recalculation of the results of the obtained measurements according to the formula included in EN 55032 (CISPR 32) standard, dedicated stand was developed and produced using 3D printer as on picture below. Reference mechanical base is permanently glued inside of GTEM250 chamber.

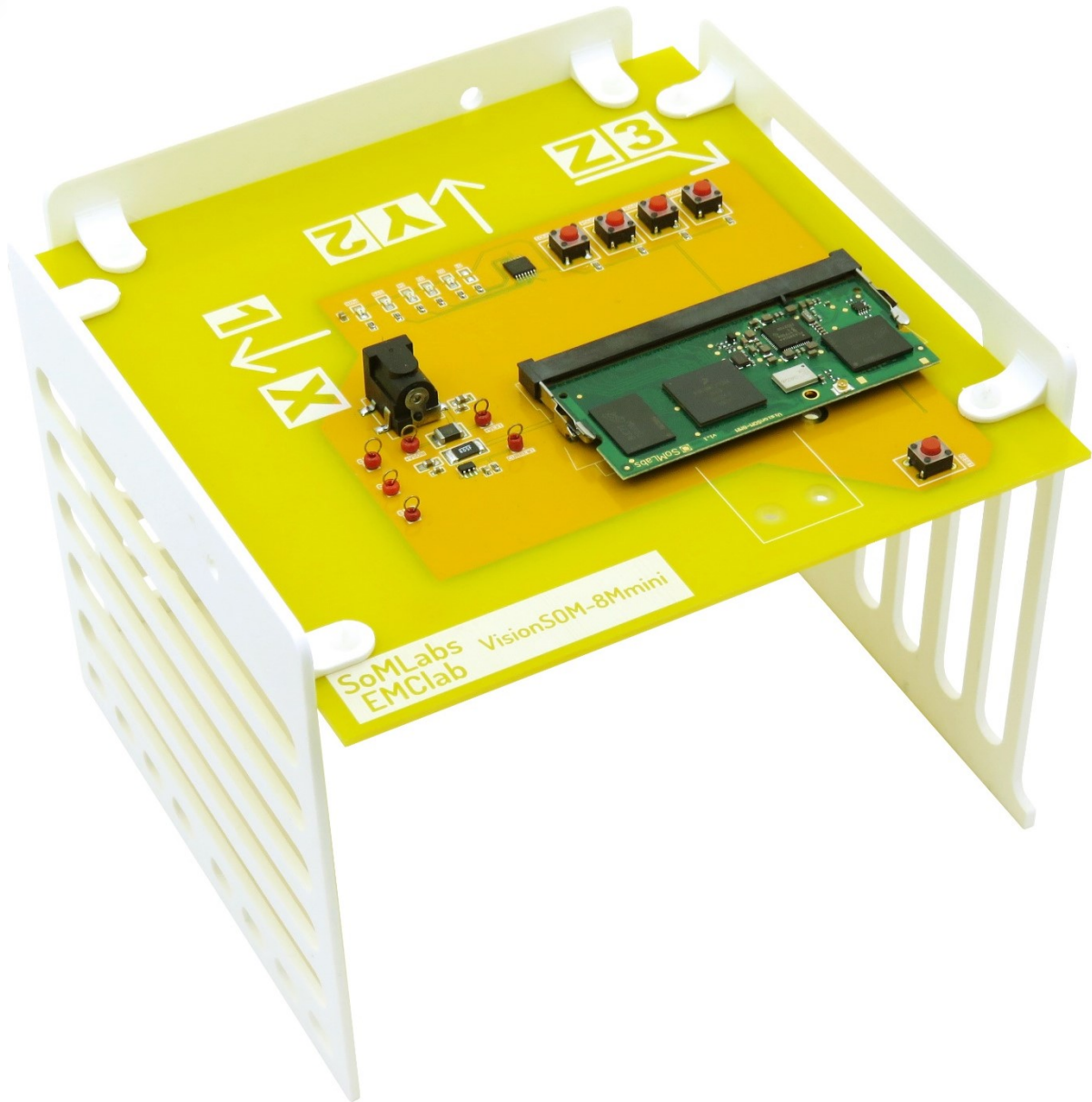

4. Measurement setup

The general view of the measuring station with the instruments used for measurements is presented below.



5. Test procedure

1. Spectrum analyzer was warmed up for 30 minutes since power supply on.
2. Power supply (+5V/250mA) was connected to GTEM filter.
3. The EUT was installed on YELLOW testing carrier board
4. The ASTAT GTEM program was started and configured.
5. Power cables were attached to the connectors: mounted on carrier board and internal in GTEM (filtered).
6. The EUT installed on YELLOW carrier board was mounted on a dedicated stand inside of GTEM in position 1 (X) – as on picture below.

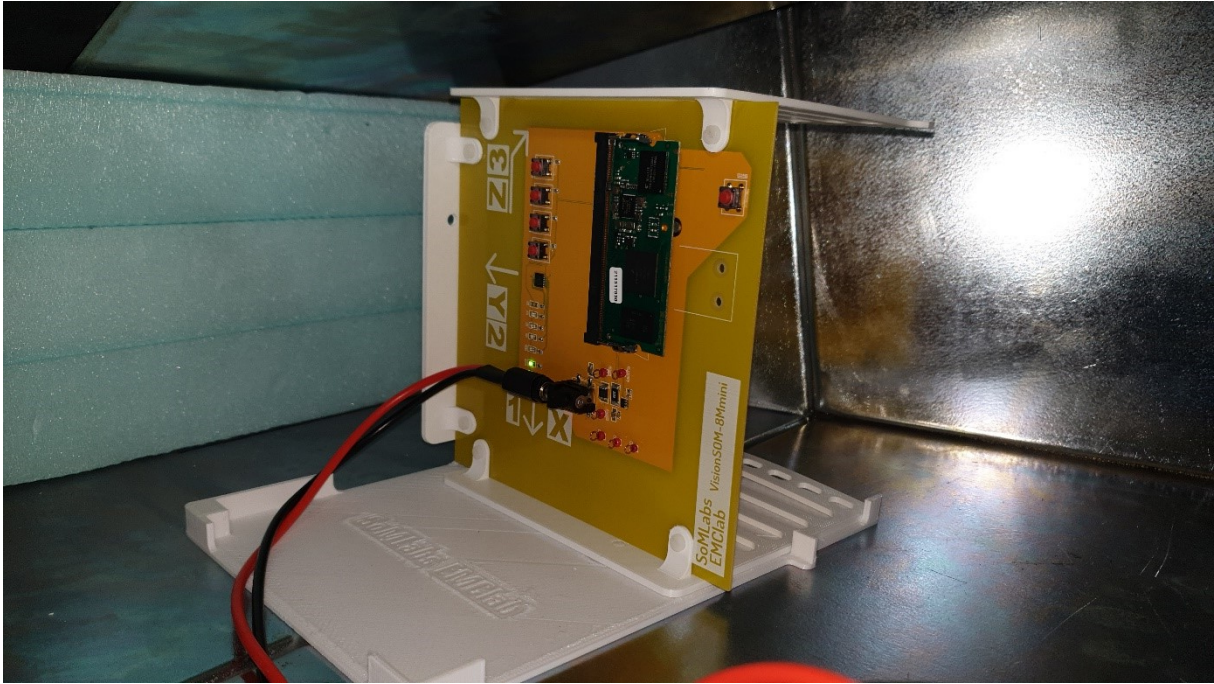

7. First measurement was started from ASTAT GTEM menu (for X axis).
8. After completing the first measurement, position of EUT with YELLOW carrier board was changed to position 2 (Y) – as on picture below.



9. Second measurement was started from ASTAT GTEM menu (for Y axis).
10. After completing the second measurement, position of EUT with YELLOW carrier board was changed to position 3 (Z) – as on picture below.



11. Third measurement was started from ASTAT GTEM menu (for Z axis).
12. After completing the third measurement, ASTAT software calculates correlated results.

6. Results

6.1. Results for 30MHz-1GHz frequency range (quasi-peak)



| 8Mmini-full-UART-QP | |
|---------------------|---|
| Operator | Piotr Zbysiński |
| EUT | VisionSOM-8Mmini |
| Uwagi | Firmware: imx-image-multimedia-visionsom-8mm-cb |
| Nazwa Firmy | SoMLabs |
| Limit | 55032 30M-1G klasa B 3m QP |
| Symulowany dystans | 3m |

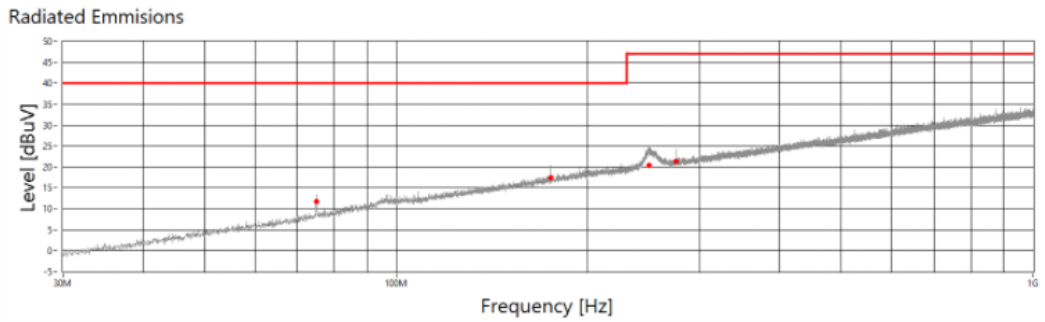

Final Scan Correlated Data

| LP | Frequency[Hz] | Level[dBuV/m] | Limit[dBuV/m] | Difference[dBm] | Detector | RBW[Hz] | Pass/Failed |
|----|---------------|---------------|---------------|-----------------|----------|---------|-------------|
| 1 | 75,00M | 11,66 | 40,00 | 28,34 | QP | 120k | pass |
| 2 | 174,96M | 17,40 | 40,00 | 22,60 | QP | 120k | pass |
| 3 | 249,36M | 20,37 | 47,00 | 26,63 | QP | 120k | pass |
| 4 | 275,04M | 21,22 | 47,00 | 25,78 | QP | 120k | pass |

6.2. Results for 1-3GHz frequency range (average)



| 8Mmini-full-UART-AVG | |
|----------------------|---|
| Operator | Piotr Zbysiński |
| EUT | VisionSOM-8Mmini |
| Uwagi | Firmware: imx-image-multimedia-visionsom-8mm-cb |
| Nazwa Firmy | SoMLabs |
| Limit | 55032 1G-3G klasa B 3m AV |
| Symulowany dystans | 3m |

Radiated Emmissions

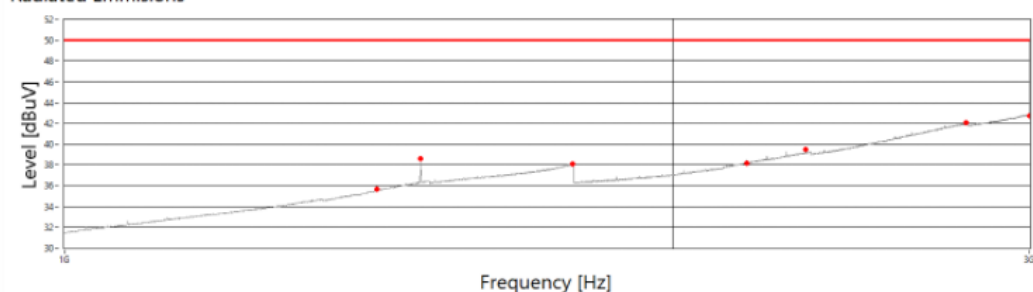

Final Scan Correlated Data

| LP | Frequency[Hz] | Level[dBuV/m] | Limit[dBuV/m] | Difference[dBm] | Detector | RBW[Hz] | Pass/Failed |
|----|---------------|---------------|---------------|-----------------|----------|---------|-------------|
| 1 | 1,43G | 35,66 | 50,00 | 14,34 | AVG | 1M | pass |
| 2 | 1,50G | 38,60 | 50,00 | 11,40 | AVG | 1M | pass |
| 3 | 1,78G | 38,07 | 50,00 | 11,93 | AVG | 1M | pass |
| 4 | 2,18G | 38,19 | 50,00 | 11,81 | AVG | 1M | pass |
| 5 | 2,33G | 39,50 | 50,00 | 10,50 | AVG | 1M | pass |
| 6 | 2,79G | 42,07 | 50,00 | 7,93 | AVG | 1M | pass |
| 7 | 3,00G | 42,72 | 50,00 | 7,28 | AVG | 1M | pass |

6.3. Results for 1-3GHz frequency range (peak)



| 8Mmini-full-UART-PK | |
|---------------------|---------------------------------------|
| Operator | Piotr Zbysiński |
| EUT | VisionSOM-8Mmini |
| Uwagi | Firmware: imx-image-multimedia-8mm-cb |
| Nazwa Firmy | SoMLabs |
| Limit | 55032 1G-3G klasa B 3m PK |
| Symulowany dystans | 3m |

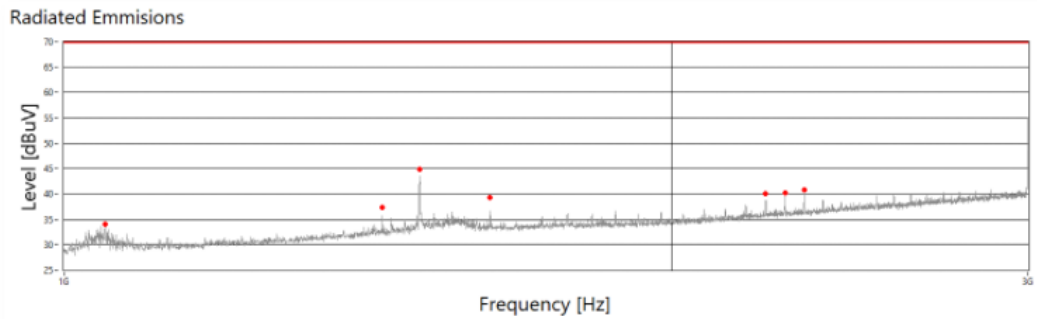

Final Scan Correlated Data

| LP | Frequency[Hz] | Level[dBuV/m] | Limit[dBuV/m] | Difference[dBm] | Detector | RBW[Hz] | Pass/Failed |
|----|---------------|---------------|---------------|-----------------|----------|---------|-------------|
| 1 | 1,05G | 34,04 | 70,00 | 35,96 | PK | 1M | pass |
| 2 | 1,44G | 37,34 | 70,00 | 32,66 | PK | 1M | pass |
| 3 | 1,50G | 44,90 | 70,00 | 25,10 | PK | 1M | pass |
| 4 | 1,63G | 39,32 | 70,00 | 30,68 | PK | 1M | pass |
| 5 | 2,23G | 40,06 | 70,00 | 29,94 | PK | 1M | pass |
| 6 | 2,28G | 40,14 | 70,00 | 29,86 | PK | 1M | pass |
| 7 | 2,33G | 40,75 | 70,00 | 29,25 | PK | 1M | pass |

6.4. Reference charts

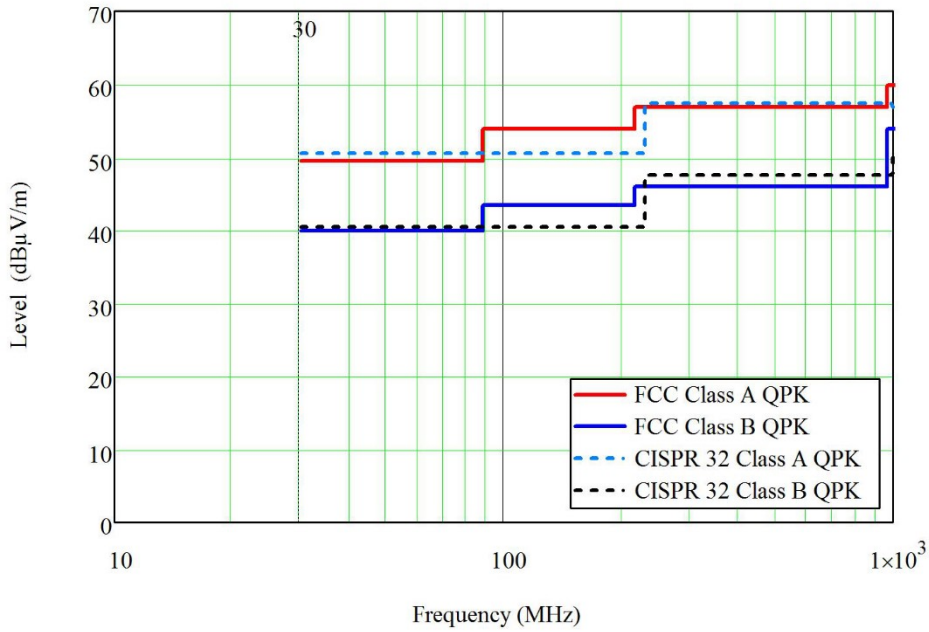

CISPR 32/FCC radiated limits for Class A and Class B in frequency range up to 1 GHz

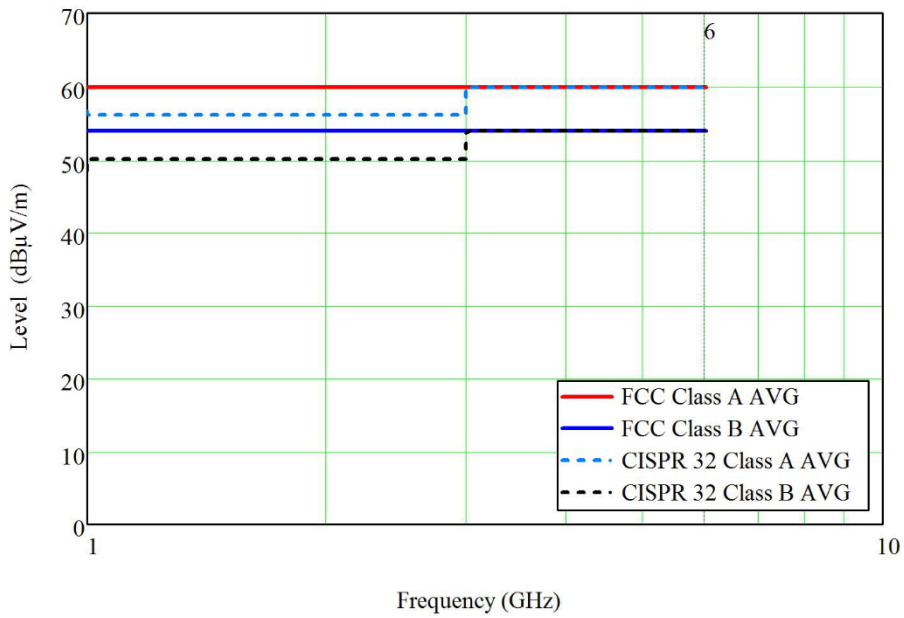

CISPR 32/FCC radiated limits for Class A and Class B in frequency range above 1 GHz

7. Summary

The conducted and documented measurements confirm that the tested modules fully meet the requirements of EN 55032 class B (CISPR 32) emission standard.

8. Limitation on Liability

Under no circumstances shall SoMLabs Sp. z o. o. be liable for any loss, damage or expense suffered or incurred with respect to any defective product.

In no event shall SoMLabs Sp. z o. o. be liable for any incidental or consequential damages that you may suffer directly or indirectly from use of any product.