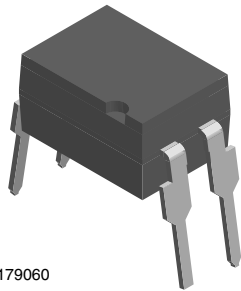
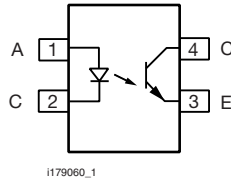




Optocoupler, Phototransistor Output, High Reliability, 5300 V_{RMS}



i179060



i179060_1

DESCRIPTION

The SFH615XXX features a large assortment of current transfer ratio, low coupling capacitance and high isolation voltage. These couplers have a GaAs infrared emitting diode emitter, which is optically coupled to a silicon planar phototransistor detector, and is incorporated in a plastic DIP-4 package.

The coupling devices are designed for signal transmission between two electrically separated circuits.

The couplers are end-stackable with 2.54 mm lead spacing. Creepage and clearance distances of > 8 mm are achieved with option 6. This version complies with 60950 (DIN VDE 0805) for reinforced insulation up to operation voltage of 400 V_{RMS} or DC.

FEATURES

- Low CTR degradation
- Good CTR linearity depending on forward current
- Isolation test voltage, 5300 V_{RMS}
- High collector emitter voltage, V_{CEO} = 70 V
- Low saturation voltage
- Fast switching times
- Temperature stable
- Low coupling capacitance
- End stackable, 0.100" (2.54 mm) spacing
- High common mode interference immunity (unconnected base)
- Material categorization: for definitions of compliance please see www.vishay.com/doc?99912

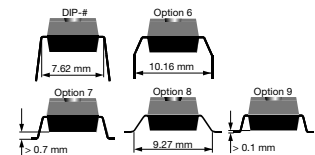
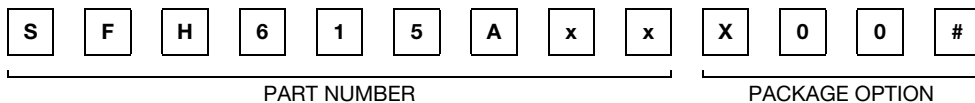


RoHS COMPLIANT

AGENCY APPROVALS

- UL1577
- cUL
- DIN EN 60747-5-5 (VDE 0884) available with option 1
- BSI

ORDERING INFORMATION



AGENCY CERTIFIED/PACKAGE	CTR (%)			
	5 mA			
UL, cUL, BSI, FIMKO	50 to 600	100 to 600	100 to 300	50 to 150
DIP-4	SFH615AA	SFH615AGB	SFH615AGR	SFH615AY
DIP-4, 400 mil, option 6	SFH615AA-X006	-	-	-
SMD-4, option 7	SFH615AA-X007	-	SFH615AGR-X007T	SFH615AY-X007T
SMD-4, option 8	-	-	-	SFH615AY-X008T
SMD-4, option 9	-	SFH615AGB-X009T	-	SFH615AY-X009T ⁽¹⁾
UL, cUL, VDE, BSI, FIMKO	50 to 600	100 to 600	100 to 300	50 to 150
DIP-4	SFH615AA-X001	-	SFH615AGR-X001	-
DIP-4, 400 mil, option 6	-	-	SFH615AGR-X016	SFH615AY-X016
SMD-4, option 7	SFH615AA-X017T ⁽¹⁾	-	SFH615AGR-X017T ⁽¹⁾	-
SMD-4, option 8	-	-	-	SFH615AY-X018T ⁽¹⁾
SMD-4, option 9	-	-	-	SFH615AY-X019T ⁽¹⁾

Notes

- Additional options may be possible, please contact sales office
- ⁽¹⁾ Also available in tubes; do not add T to end



ABSOLUTE MAXIMUM RATINGS (T _{amb} = 25 °C, unless otherwise specified)				
PARAMETER	TEST CONDITION	SYMBOL	VALUE	UNIT
INPUT				
Reverse voltage		V _R	6	V
DC forward current		I _F	60	mA
Surge forward current	t _p ≤ 10 ms	I _{FSM}	2.5	A
Power dissipation		P _{diss}	100	mW
OUTPUT				
Collector emitter voltage		V _{CEO}	70	V
Emitter collector voltage		V _{ECO}	7	V
Collector current		I _C	50	mA
	t _p ≤ 10 ms	I _C	100	mA
Total power dissipation		P _{diss}	150	mW
COUPLER				
Isolation test voltage between emitter and detector		V _{ISO}	5300	V _{RMS}
Creepage distance			≥ 7	mm
Clearance distance			≥ 7	mm
Isolation thickness between emitter and detector Comparative tracking index per DIN IEC 112/VDE 0303, part 1		CTI	≥ 175	
Isolation resistance	V _{IO} = 500 V, T _{amb} = 25 °C	R _{IO}	≥ 10 ¹²	Ω
	V _{IO} = 500 V, T _{amb} = 100 °C	R _{IO}	≥ 10 ¹¹	Ω
Storage temperature range		T _{stg}	-55 to +150	°C
Ambient temperature range		T _{amb}	-55 to +100	°C
Soldering temperature ⁽¹⁾	max. 10 s, dip soldering distance to seating plane ≥ 1.5 mm	T _{slid}	260	°C

Notes

- Stresses in excess of the absolute maximum ratings can cause permanent damage to the device. Functional operation of the device is not implied at these or any other conditions in excess of those given in the operational sections of this document. Exposure to absolute maximum ratings for extended periods of the time can adversely affect reliability.
- ⁽¹⁾ Refer to reflow profile for soldering conditions for surface mounted devices (SMD). Refer to wave profile for soldering conditions for through hole devices (DIP).

ELECTRICAL CHARACTERISTICS (T _{amb} = 25 °C, unless otherwise specified)							
PARAMETER	TEST CONDITION	PART	SYMBOL	MIN.	TYP.	MAX.	UNIT
INPUT							
Forward voltage	I _F = 60 mA		V _F	-	1.25	1.65	V
Reverse current	V _R = 6 V		I _R	-	0.01	10	μA
Capacitance	V _R = 0 V, f = 1 MHz		C _O	-	13	-	pF
Thermal resistance			R _{thja}	-	750	-	K/W
OUTPUT							
Collector emitter capacitance	V _{CE} = 5 V, f = 1 MHz		C _{CE}	-	5.2	-	pF
Thermal resistance			R _{thja}	-	500	-	K/W
Collector emitter saturation voltage	I _F = 10 mA, I _C = 2.5 mA		V _{CEsat}	-	0.25	0.4	V
Coupling capacitance			C _C	-	0.4	-	pF
COUPLER							
Collector emitter leakage current	V _{CEO} = 10 V	SFH615AA	I _{CEO}	-	10	100	nA
		SFH615AGB	I _{CEO}	-	10	100	nA
		SFH615AGR	I _{CEO}	-	10	100	nA
		SFH615AY	I _{CEO}	-	10	100	nA

Note

- Minimum and maximum values are testing requirements. Typical values are characteristics of the device and are the result of engineering evaluation. Typical values are for information only and are not part of the testing requirements.

CURRENT TRANSFER RATIO							
PARAMETER	TEST CONDITION	PART	SYMBOL	MIN.	TYP.	MAX.	UNIT
I_C/I_F	$I_F = 5 \text{ mA}, V_{CE} = 5 \text{ V}$	SFH615AA	CTR	50	-	600	%
		SFH615AGB	CTR	100	-	600	%
		SFH615AGR	CTR	100	-	300	%
		SFH615AY	CTR	50	-	150	%

SWITCHING CHARACTERISTICS							
PARAMETER	TEST CONDITION	SYMBOL	MIN.	TYP.	MAX.	UNIT	
Turn-on time	$I_F = 5 \text{ mA}$	t_{on}	-	2	-	μs	
Turn-off time	$I_F = 5 \text{ mA}$	t_{off}	-	25	-	μs	

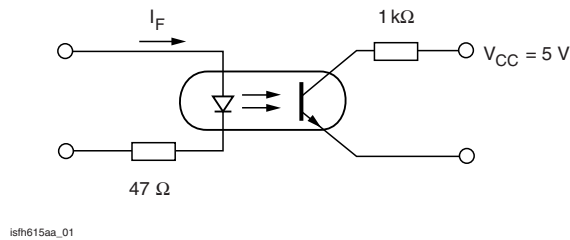
TYPICAL CHARACTERISTICS ($T_{amb} = 25 \text{ }^\circ\text{C}$, unless otherwise specified)


Fig. 1 - Switching Operation (with saturation)

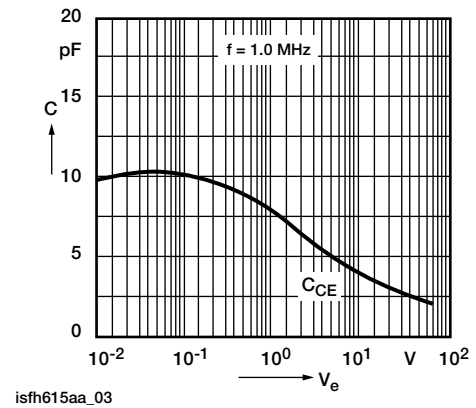


Fig. 3 - Transistor Capacitance (typ.) vs. Collector Emitter Voltage

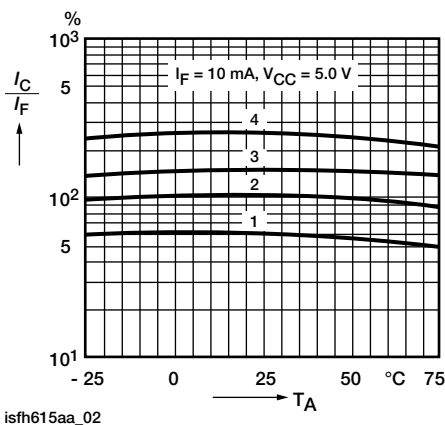


Fig. 2 - Current Transfer Ratio (typ.) vs. Temperature

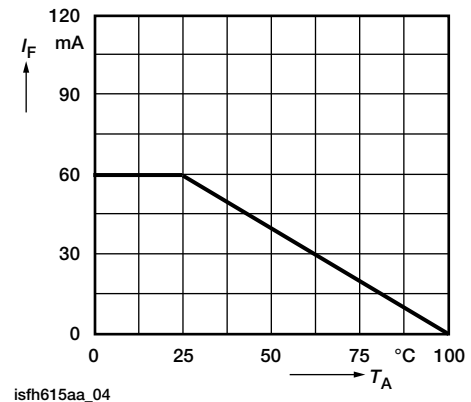


Fig. 4 - Permissible Diode Forward Current vs. Ambient Temperature

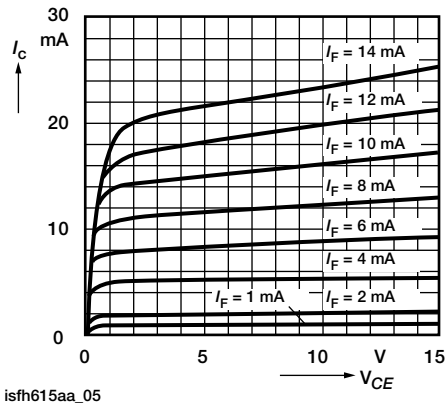


Fig. 5 - Output Characteristics (typ.) Collector Current vs. Collector Emitter Voltage

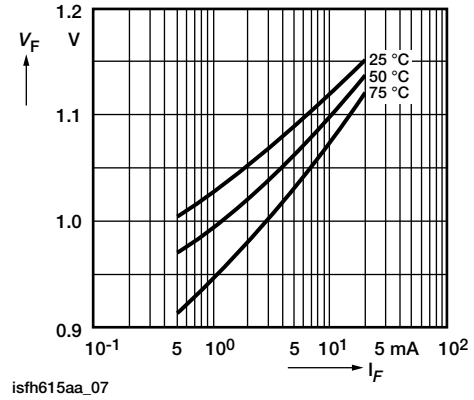


Fig. 7 - Diode Forward Voltage (typ.) vs. Forward Current

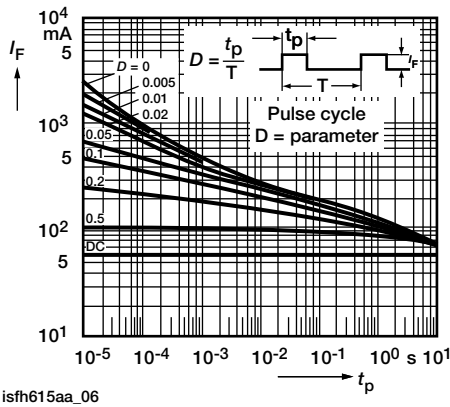


Fig. 6 - Permissible Pulse Handling Capability Forward Current vs. Pulse Width

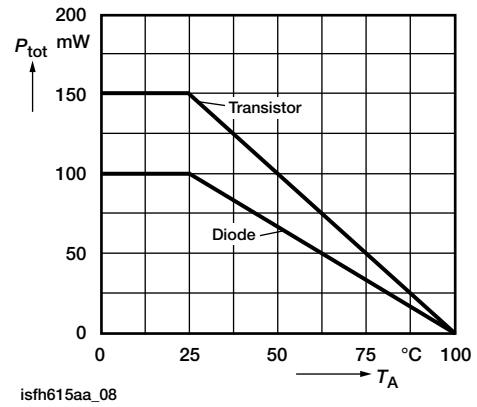
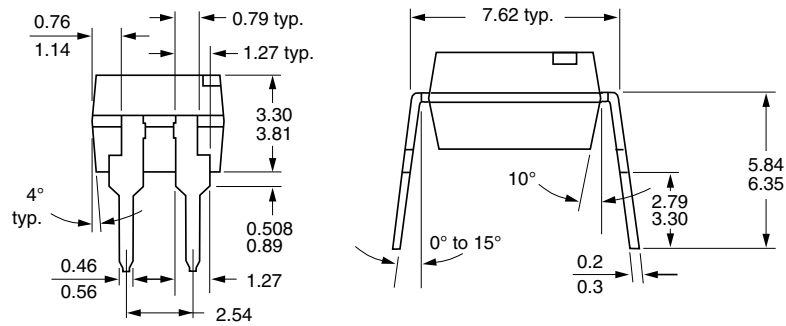
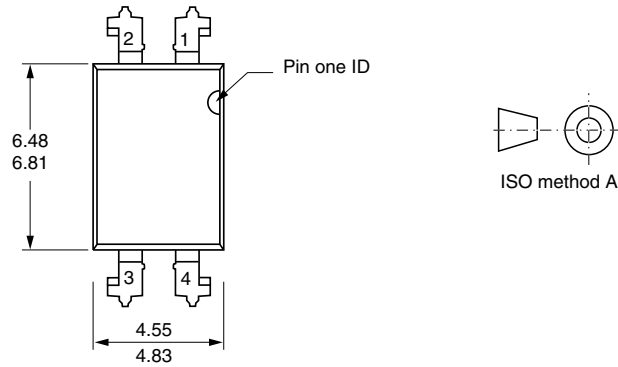


Fig. 8 - Permissible Power Dissipation vs. Temperature

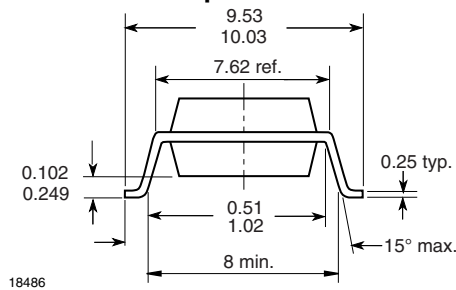


PACKAGE DIMENSIONS in inches (millimeters)



i178027

Option 9



18486



Disclaimer

ALL PRODUCT, PRODUCT SPECIFICATIONS AND DATA ARE SUBJECT TO CHANGE WITHOUT NOTICE TO IMPROVE RELIABILITY, FUNCTION OR DESIGN OR OTHERWISE.

Vishay Intertechnology, Inc., its affiliates, agents, and employees, and all persons acting on its or their behalf (collectively, "Vishay"), disclaim any and all liability for any errors, inaccuracies or incompleteness contained in any datasheet or in any other disclosure relating to any product.

Vishay makes no warranty, representation or guarantee regarding the suitability of the products for any particular purpose or the continuing production of any product. To the maximum extent permitted by applicable law, Vishay disclaims (i) any and all liability arising out of the application or use of any product, (ii) any and all liability, including without limitation special, consequential or incidental damages, and (iii) any and all implied warranties, including warranties of fitness for particular purpose, non-infringement and merchantability.

Statements regarding the suitability of products for certain types of applications are based on Vishay's knowledge of typical requirements that are often placed on Vishay products in generic applications. Such statements are not binding statements about the suitability of products for a particular application. It is the customer's responsibility to validate that a particular product with the properties described in the product specification is suitable for use in a particular application. Parameters provided in datasheets and / or specifications may vary in different applications and performance may vary over time. All operating parameters, including typical parameters, must be validated for each customer application by the customer's technical experts. Product specifications do not expand or otherwise modify Vishay's terms and conditions of purchase, including but not limited to the warranty expressed therein.

Except as expressly indicated in writing, Vishay products are not designed for use in medical, life-saving, or life-sustaining applications or for any other application in which the failure of the Vishay product could result in personal injury or death. Customers using or selling Vishay products not expressly indicated for use in such applications do so at their own risk. Please contact authorized Vishay personnel to obtain written terms and conditions regarding products designed for such applications.

No license, express or implied, by estoppel or otherwise, to any intellectual property rights is granted by this document or by any conduct of Vishay. Product names and markings noted herein may be trademarks of their respective owners.