

DETAILS

Product Number	C12473_SIRI-A
Family	Siri
Type	Lens
Color	clear
Diameter	13,9 mm
Height	4,2 mm
Style	square
Optic Material	PMMA
Holder Material	
Fastening	pin, glue
Status	production ready
ROHS Compliant	Yes
Date Updated	19/12/2013

OPTICAL PROPERTIES

LED	Viewing Angle	Light Beam	Efficiency	cd/lm	Connector
XT-E	74+137 deg	Wide-Area...	95 %	0.300	-
XP-G2	142 deg	Wide-Area...	94 %	0.300	-
NVSxx19A	58+132 deg	Wide-Area...	95 %	0.330	-
Oslon Square PC	66+134 deg	Wide-Area...	95 %	0.310	-
Z8Y22P	sim: 126+134	Wide-Area...	sim: 97 %	sim: 0.290	-

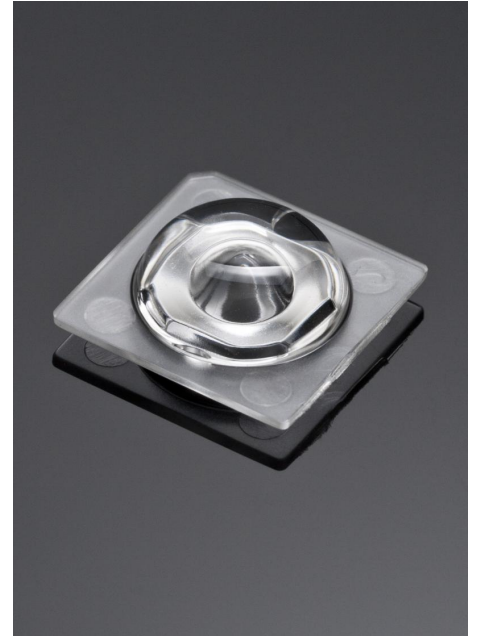

Relative intensity of Siri-A_(XT-E)

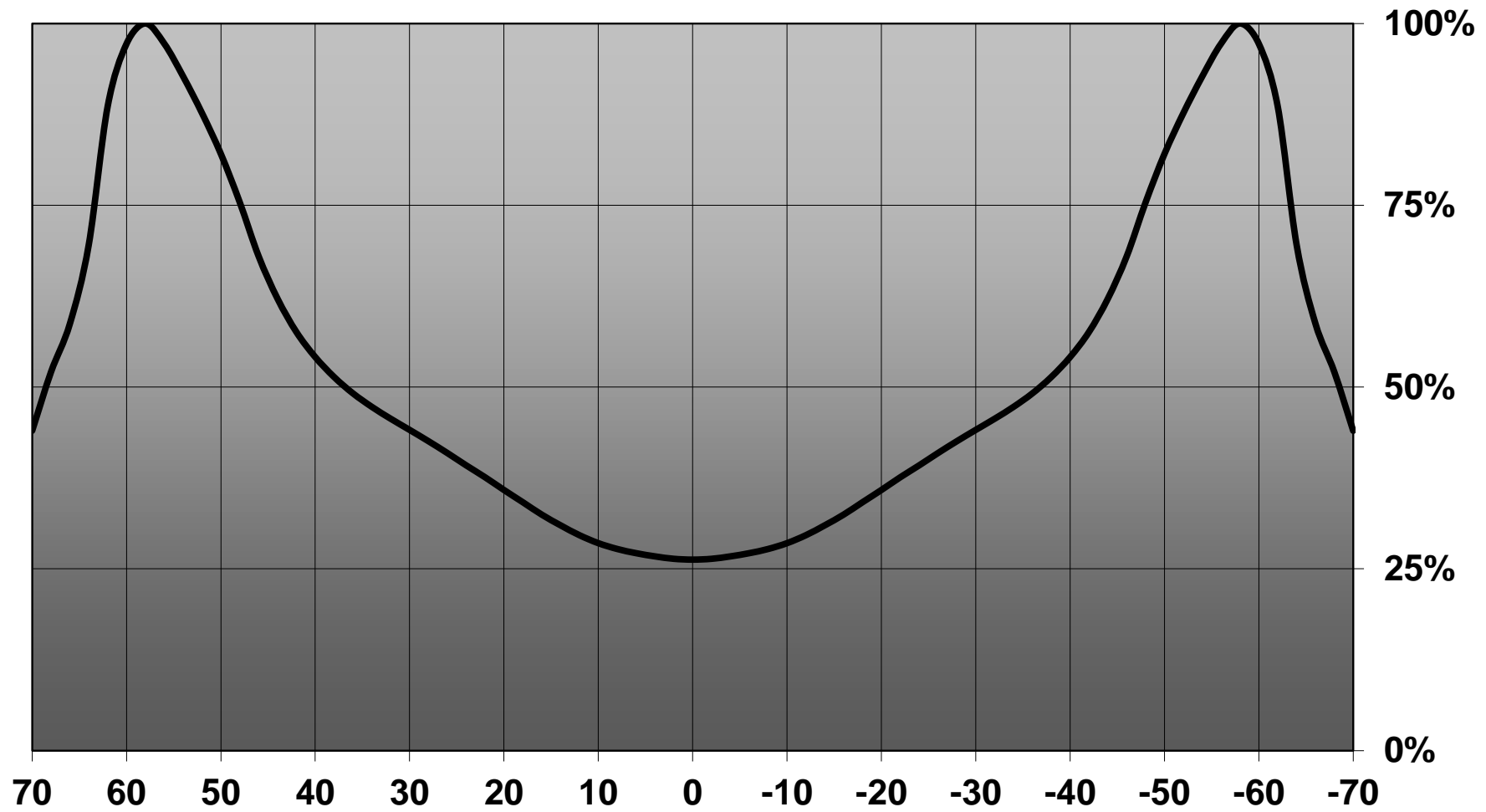

Relative intensity of Siri-A_(N219)

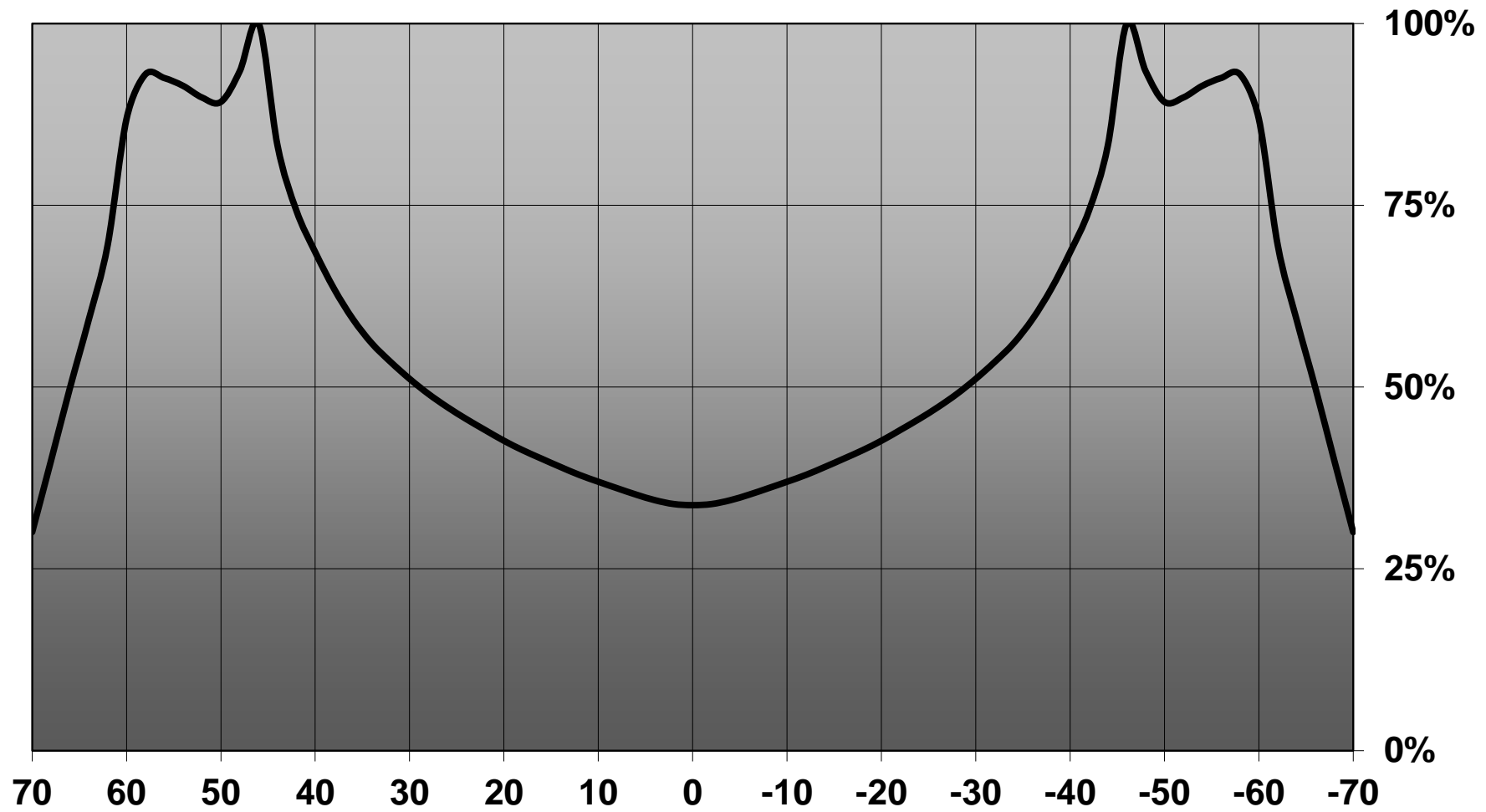

Relative intensity of Siri-A_(SQ_EC)

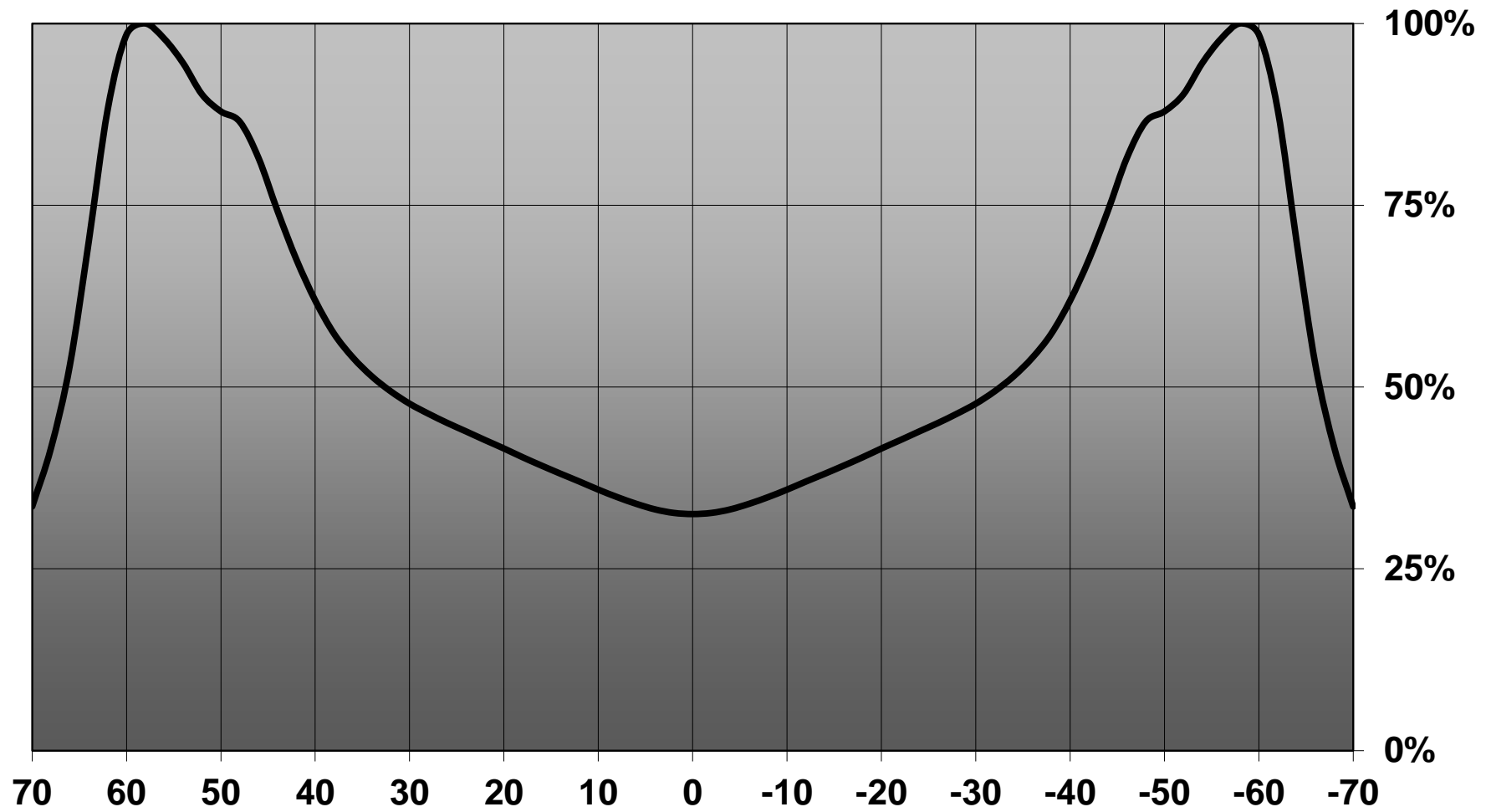

D

C

B

A

4

4

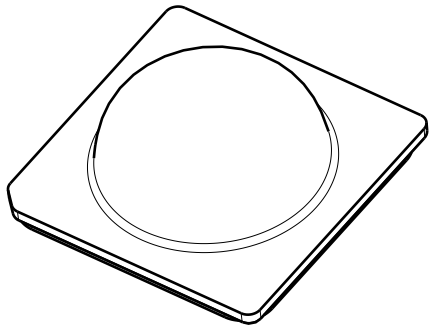

Isometric view

positioning pins

8.6

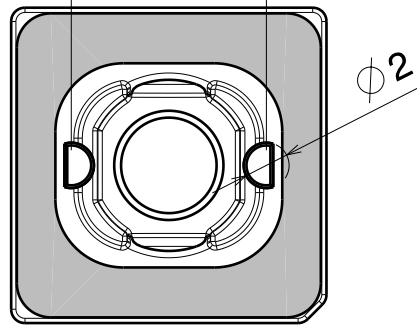

Bottom view

3

3

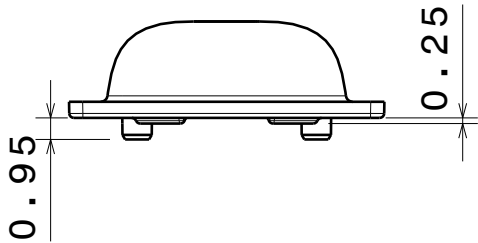

Front view of C12473_Siri-A without adhesive tape

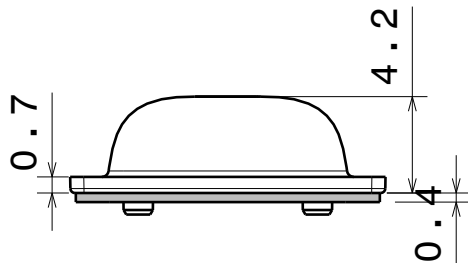

Front view

2

2

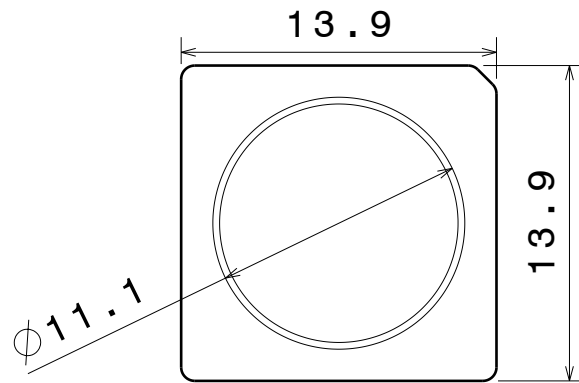

Top view

MATERIALS
 Lens: PMMA
 Tape: PU FOAM

This drawing is our property.
 It can't be reproduced
 or communicated without
 our written agreement.



L
S
F
F

e
i
i
n

d

DRAWING TITLE

Datasheet Siri-A-tape

1

1

DRAWN BY

DATE

12.12.2011

CHECKED BY

DATE

12.12.2011

DESIGNED BY

DATE

12.12.2011

SIZE

A4

DRAWING NUMBER

CA12474

REV

1

SCALE

3:1

WEIGHT (g)

SHEET

1/1

D

A

Luminaire: LEDIL OY C12473_SIRI-A / CA12474_SIRI-A (XT-E AWT) Efficiency=95%
Lamps: 1 x Cree XT-E AWT (113lm@250mA)

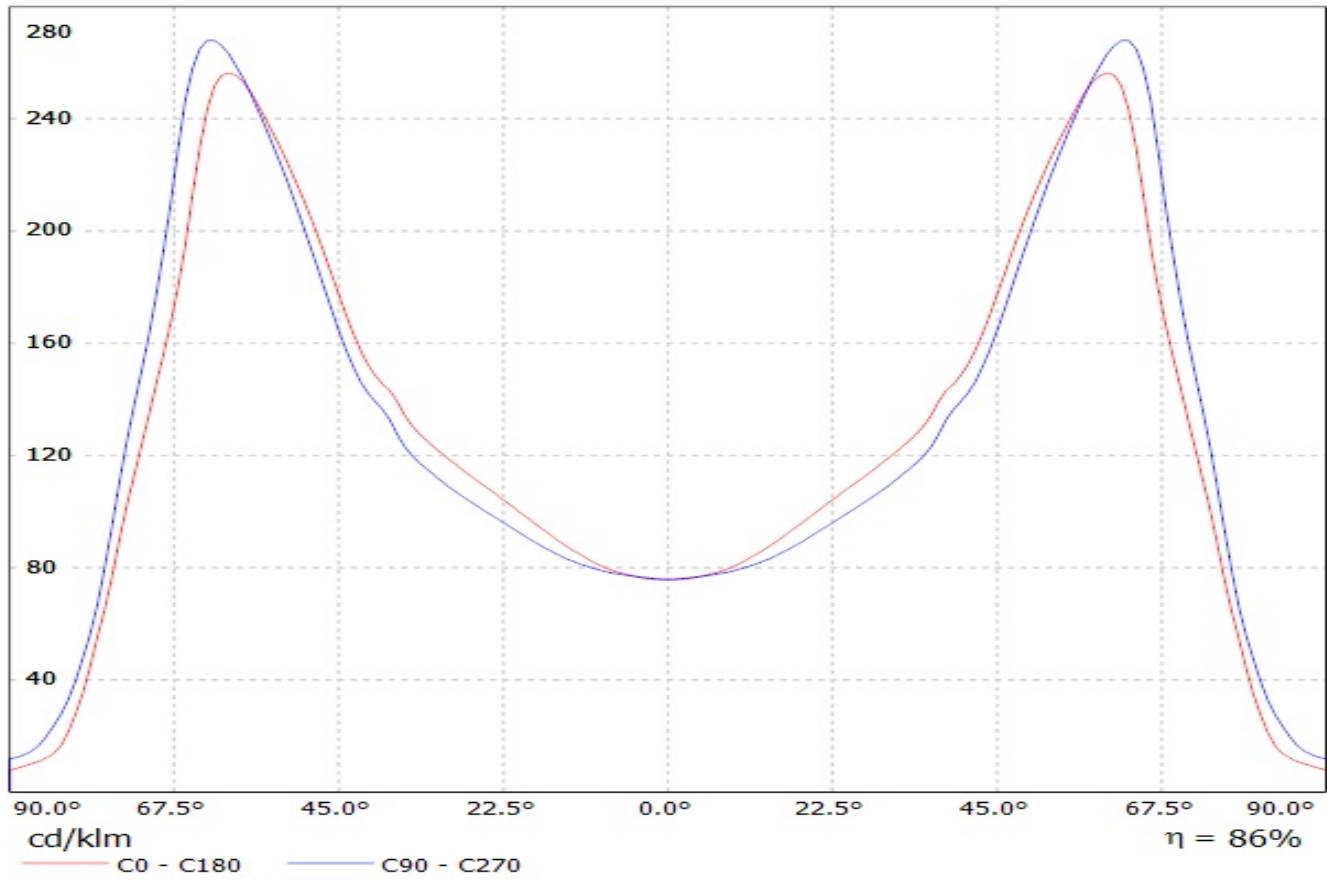

Luminaire: LEDiL Oy C12473_SIRI-A_(XP-G2) Eff. 94%

Lamps: 1 x CREE_XP-G2_(XPGBWT-H1-7B4-R4-0-04)_105lm@250mA_P=0.755848W_I=249.9mA

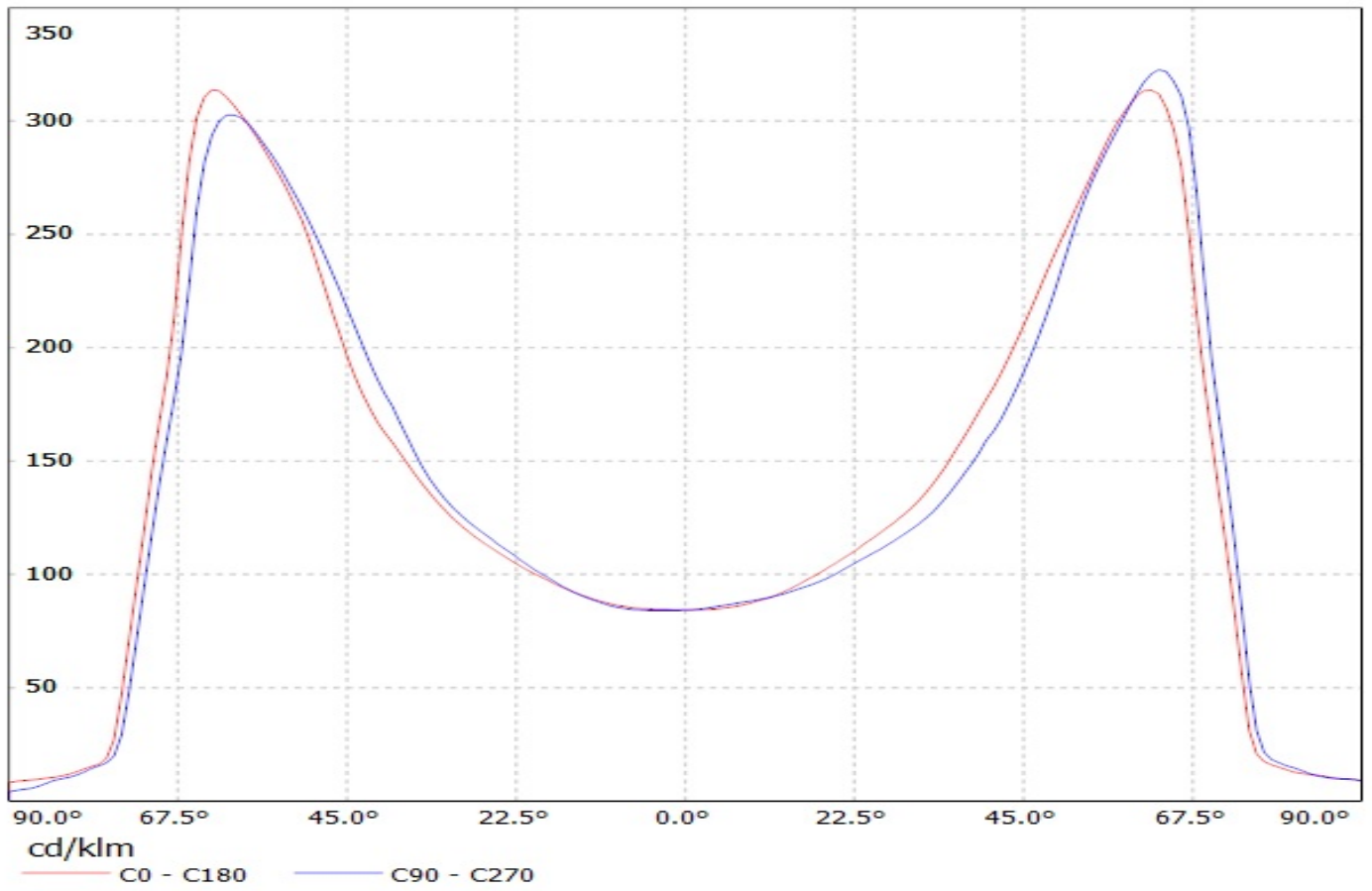

Luminaire: Ledil Oy C12473_SIRI-A_SEOUL_Z8Y22+_SIMULATED
Lamps: 1 x SEOUL Z8Y22 Plus

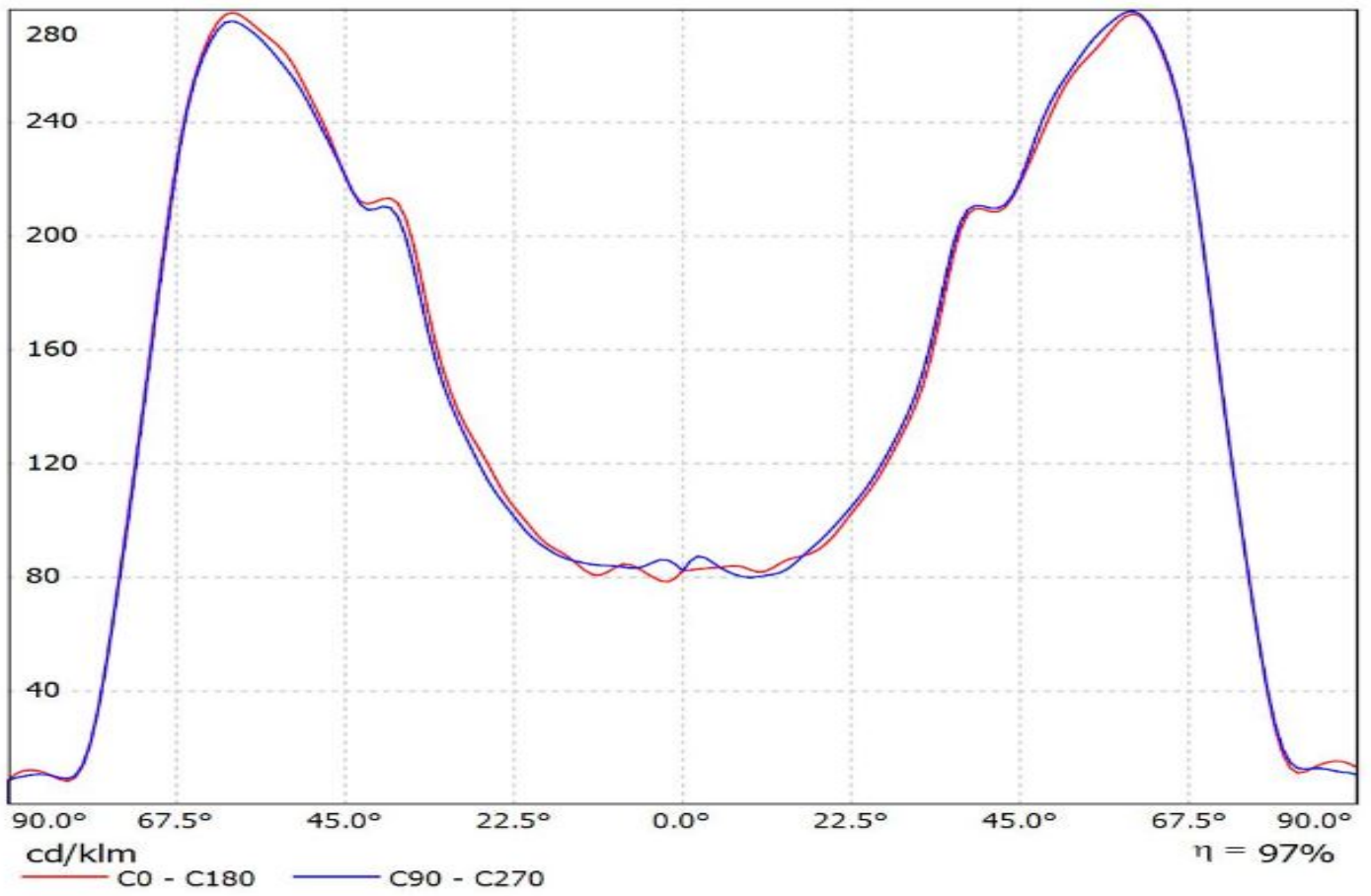

Luminaire: LEDIL OY C12473_SIRI-A / CA12474_SIRI-A (XT-E AWT) Efficiency=95%
Lamps: 1 x Cree XT-E AWT (113lm@250mA)

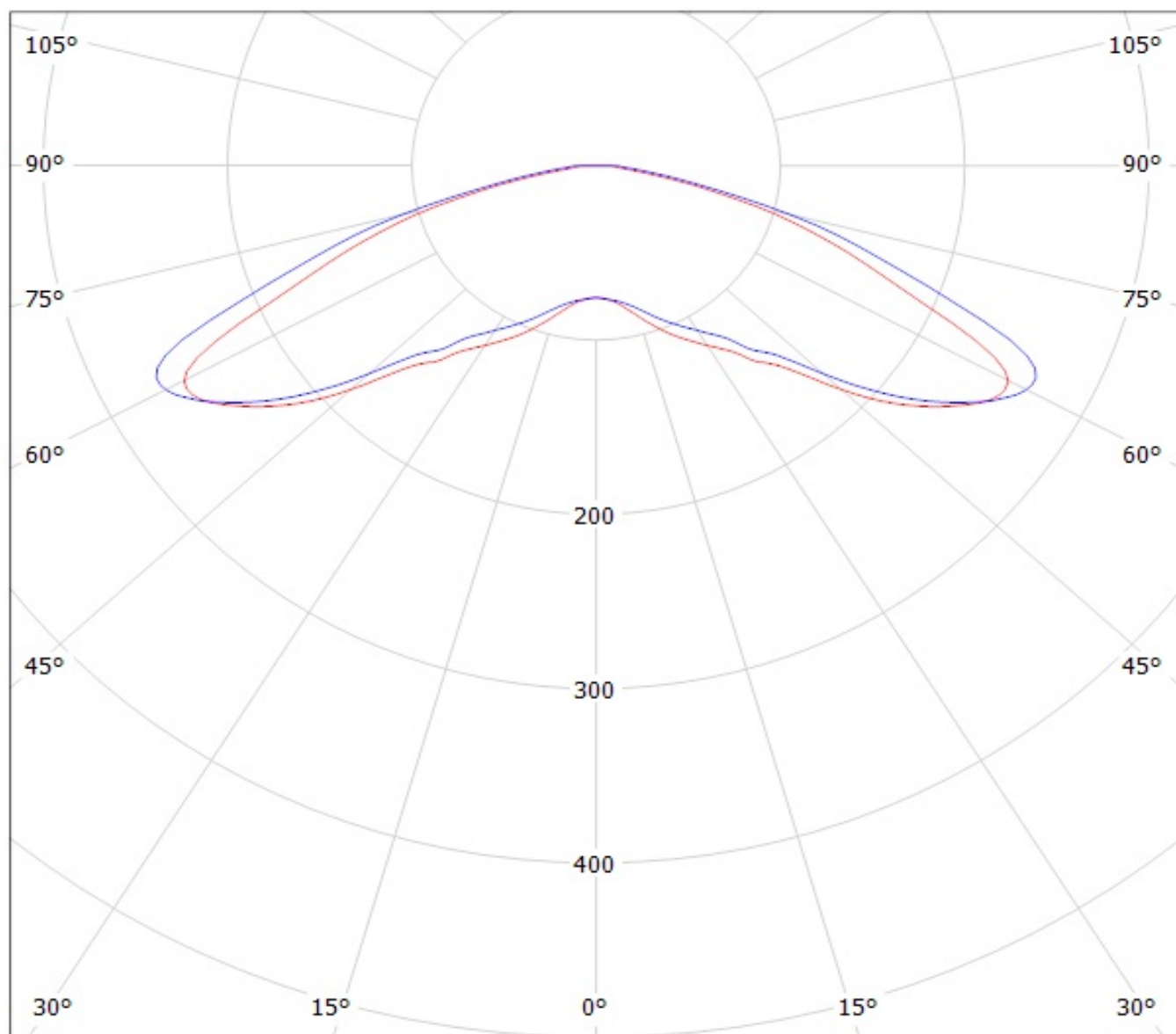

cd/klm

— C0 - C180 — C90 - C270

$\eta = 86\%$

Luminaire: LEDiL Oy C12473_SIRI-A_(XP-G2) Eff: 94%

Lamps: 1 x CREE_XP-G2_(XPGBWT-H1-7B4-R4-0-04)_105lm@250mA_P=0.755848W_I=249.9mA

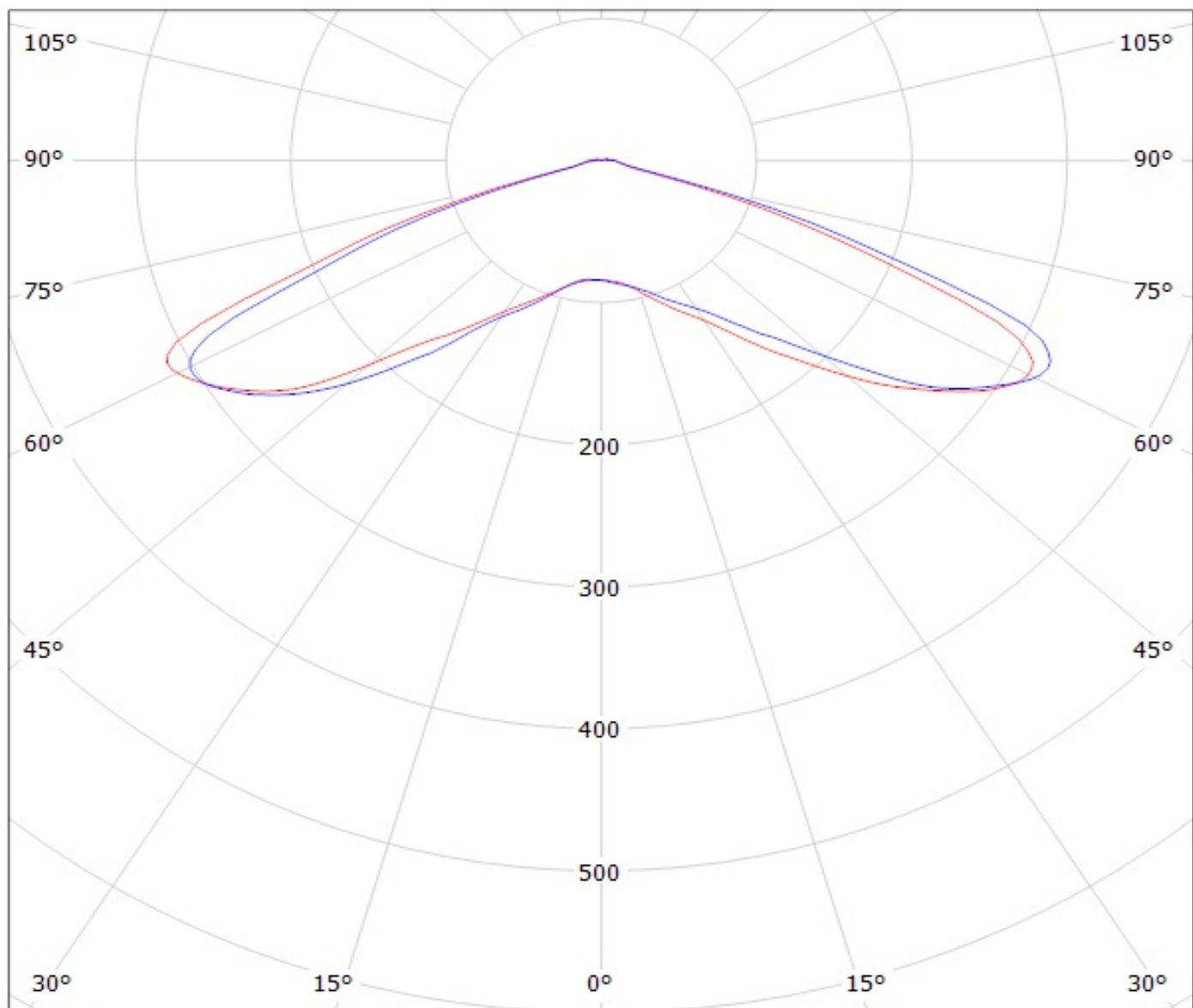

cd/klm

— C0 - C180

— C90 - C270

Luminaire: Ledil Oy C12473_SIRI-A_SEOUL_Z8Y22+_SIMULATED
Lamps: 1 x SEOUL Z8Y22 Plus

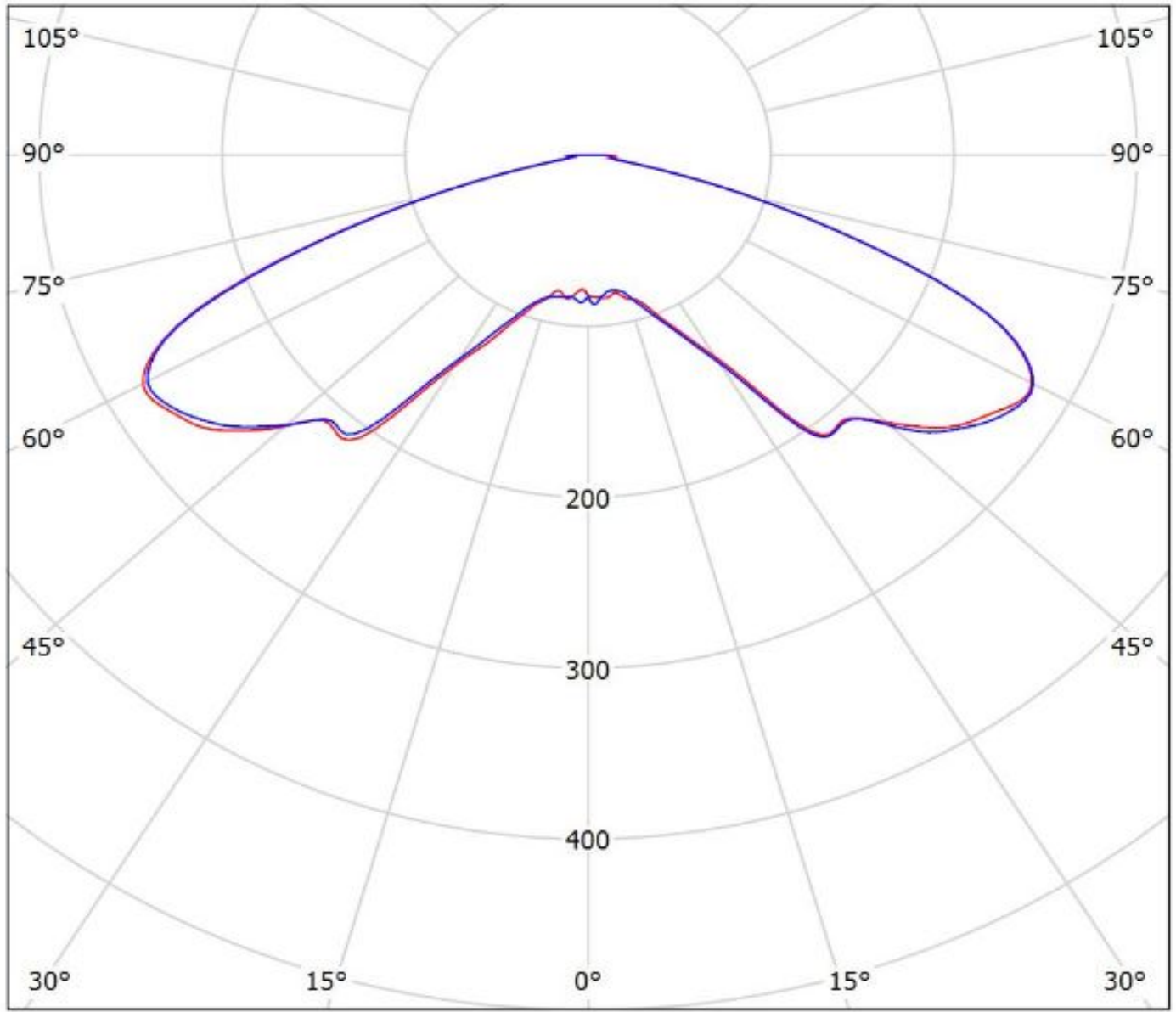

cd/klm
— C0 - C180 — C90 - C270

$\eta = 97\%$

NOTE: The typical divergence will be changed by different color, chip size and chip position tolerance. The typical total divergence is the full angle measured where the luminous intensity is half of the peak value.