

## Data sheet

Commercial Art.No.: 25.622.3853.0

PCB connector 8813 B / 8 VR OB

PCB female connector with screw connection with rising cage clamp system, 8 poles, max. cross section: 1.5 mm<sup>2</sup>, pitch: 3.81 mm, type of packing: carton, color: grey

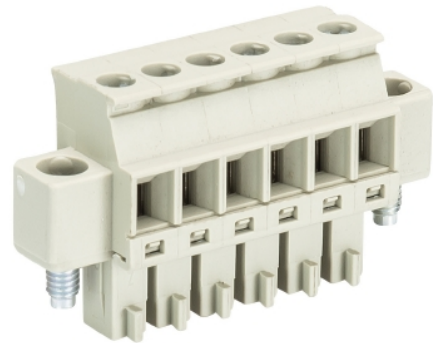

Commercial Art.No.	25.622.3853.0
EAN	4015573480520
Order Unit	50

Certificates / Approvals



## Technical data

### General

Modular spacing	3.81 mm
Connection type	screw connection
Soldering process	None
Packaging	Carton
Number of poles	8
Marking	No
Fastening	None
Mating direction towards connector	90°

### Technical data

Nominal cross section	1.5 mm <sup>2</sup>
Rated current	8 A
Overvoltage Category I	690 V
Overvoltage Category II	250 V
Overvoltage Category III	125
Rated impulse voltage	2.5 kV
Wire strip length	6.5 mm

### Connection Data

Minimum cross section solid	0.14 mm <sup>2</sup>
Maximum cross section solid	1.5 mm <sup>2</sup>
Minimum cross section fine stranded	0.14 mm <sup>2</sup>
Maximum cross section fine stranded	1.5 mm <sup>2</sup>
Wire strip length	6.5 mm

**Technical Data UL/CSA**

Cross section UL	30-16 AWG
Voltage UL	300 V
Current field wiring	8 A
Current factory wiring	8 A
Cross section CSA	22-14 AWG
Voltage CSA	300 V
Current CSA	5 A

**Other**

Type of insulation material	Thermoplastic
Color	Grey
Height	19.1 mm
Length	31.27 mm
Depth	10.4 mm
Material attachment screw	Steel
Material contact base	CuSn
Material contact surface	Sn

**Classification**

ECLASS 11	
ECLASS 8.1	27440402
ETIM 7.0	EC002637
ETIM 6.0	EC002637
ETIM 5.0	EC002637
ETIM 4.0	EC002637

**Product compliance**

ROHS conformity status	Compliant/Exempted
ROHS exceptions	III-6(c)
REACH-SVHC conformity status	Duty-To-Declare
REACH-SVHC substances	Lead
REACH-SVHC CAS numbers	7439-92-1

**Fits with**

Commercial Art.No.:	Article-type description:	Description:
25.626.0853.0	PCB pin header 8813 S / 8 G OB	PCB pin header with pin header, connection method depends on used socket part , 8 poles, pitch: 3.81 mm, type of packing: carton, color: grey
25.627.0853.0	PCB pin header 8813 S / 8 W OB	PCB pin header with pin header, connection method depends on used socket part , 8 poles, pitch: 3.81 mm, type of packing: carton, color: grey
27.627.0808.0	PCB pin header 8813 S/ 8 W OB THR	PCB pin header, 8 poles, with solder pin (1.5mm, tin plated), pitch: 3.81 mm, type of packing: carton, color: black, This product can be soldered by reflow and wave soldering,
27.626.0808.0	PCB pin header 8813 S/ 8 G OB THR	PCB pin header, 8 poles, with solder pin (1.5mm, tin plated), pitch: 3.81 mm, type of packing: carton, color: black, This product can be soldered by reflow and wave soldering,

8-polige Ausführung gezeichnet  
 Ab 7-poliger Ausführung ohne Bremsflächen  
 8 pole version drawn  
 No ribs drawn on the outer surface of the first  
 and last pole from 7 pole version

A-A

Ober- und Unterteil  
 verrastet  
 upper part and lower part locked

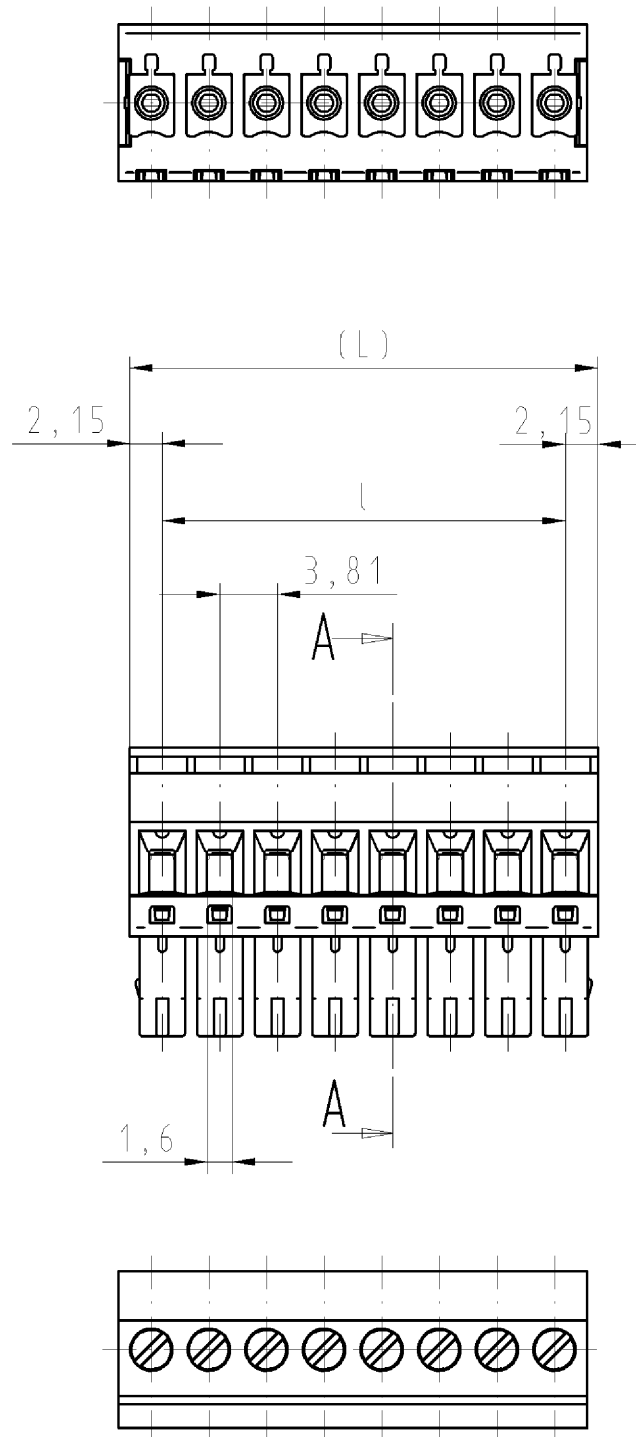
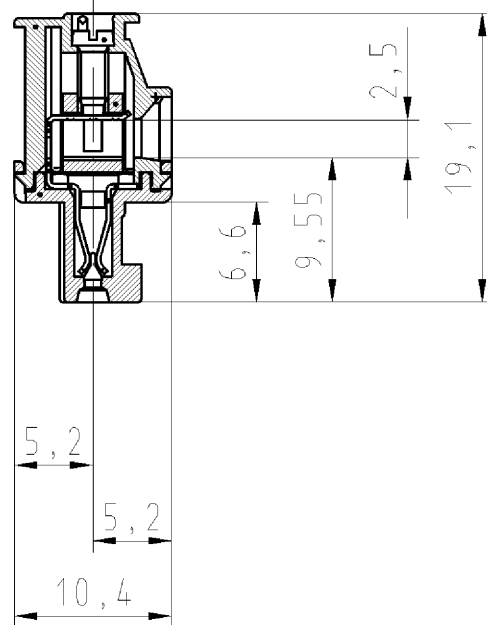

4-polige Ausführung gezeichnet  
 4 pole version drawn

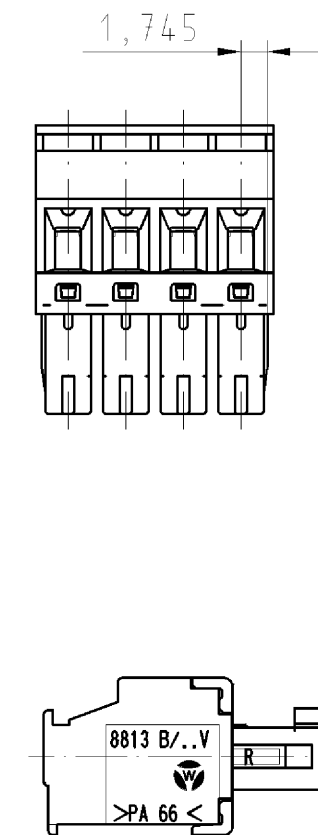

Bei 2-6polig  
 (25.622.3253.F, 25.622.3353.F, 25.622.3453.F  
 25.622.3553.F, 25.622.3653.F)  
 sind am Isoliergehäuse Bremsflächen an den  
 Außenflächen am ersten und letzten Pol

2-6 pole version  
 (25.622.3253.F, 25.622.3353.F, 25.622.3453.F  
 25.622.3553.F, 25.622.3653.F)  
 with ribs on the outer surface  
 of the first and last pole

Artikel-Nr. part number	Pol- zahl pole	(L)	l	Typ type
25.622.3253.F	2	8,11	3,81	8813/ 2VRCB
25.622.3353.F	3	11,92	7,62	8813/ 3VRCB
25.622.3453.F	4	15,73	11,43	8813/ 4VRCB
25.622.3553.F	5	19,54	15,24	8813/ 5VRCB
25.622.3653.F	6	23,35	19,05	8813/ 6VRCB
25.622.3753.F	7	27,16	22,86	8813/ 7VRCB
25.622.3853.F	8	30,97	26,67	8813/ 8VRCB
25.622.3953.F	9	34,78	30,48	8813/ 9VRCB
25.622.4053.F	10	38,59	34,29	8813/10VRCB
25.622.4153.F	11	42,40	38,10	8813/11VRCB
25.622.4253.F	12	46,21	41,91	8813/12VRCB
25.622.4353.F	13	50,02	45,72	8813/13VRCB
25.622.4453.F	14	53,83	49,53	8813/14VRCB
25.622.4553.F	15	57,64	53,34	8813/15VRCB
25.622.4653.F	16	61,45	57,15	8813/16VRCB
25.622.4753.F	17	65,26	60,96	8813/17VRCB
25.622.4853.F	18	69,07	64,77	8813/18VRCB
25.622.4953.F	19	72,88	68,58	8813/19VRCB
25.622.5053.F	20	76,69	72,39	8813/20VRCB

Weitere Daten siehe Katalog  
 further data see catalog

.F	Farbe/ colour	Bedruckung/Farbe printing/colour
.0	grau/grey	schwarz/black
.1	schwarz/black	weiß/white
.7	grün/green	schwarz/black

Tolerierung nach DIN 7167/Tolerance system acc. to DIN 7167. [This DIN-standard describes the envelope principle. According to the envelope principle the deviations of form and parallelism are limited by the size tolerances].		ja/yes <input checked="" type="checkbox"/> Stoffverbots- und Deklarationsliste nach UU-TQM-05/03 ist einzuhalten. Conformity with Wieland document UU-TQM-05/03 (list of prohibited / declarable hazardous substances) to be declared!	
Freitoleranz nach General tolerance		CAD - Zeichnung, keine manuellen Änderungen CAD - drawing, no manual modifications allowed	1. Verwendung: First Use: -
Blatt: 1 von 1 Sheet: of 1		Zeichnung Nr./Drawing No. Index	
Werkstoff/Material		2008 Tag/Date	Name
/		gezeichnet drawn 10.03.	Schmitt J.
/ Maßstab/Scale		geprüft checked -	
/ 2:1		Normgepr. Stand. check -	
Vol. mm <sup>3</sup> Ofl./Surf. mm <sup>2</sup>		Ersatz für/Replacement for: -	
/		Type	Benennung/Title
/		LP_STECKKLEMME	
Index Datum / Blatt Date / Sheet		mit Steck-u. Schraubanschluß, Rastermaß/pitch 3,81 PCB CONNECTOR, rising cage clamp system	
Änderung/Revision		8813/ 2-20VROB	

Weitergabe sowie Vervielfältigung dieses Dokuments, Verwertung und Mitteilung seines Inhalts sind verboten, soweit nicht ausdrücklich gestattet. The reproduction, distribution and utilization of this document as well as the communication of its contents to others without express authorization is prohibited.