

Data sheet

Commercial Art.No.: 72.310.1653.0

Male insert BAS STS 16 2,5 69

Male insert revos basic, 16-poles, rated current: 16A, rated voltage: 690V, with tin-plated contacts



Commercial Art.No.	72.310.1653.0
EAN	4015573227279
Order Unit	10

Certificates / Approvals



Technical data

General

Model	Pin insert
Inflammability class of insulation material acc. with UL94	V0
Color	Grey
Mating cycles	200
Pollution degree	3
Modular version	No
Operating temperature range min.	-40 °C
Operating temperature range max.	120 °C

Connection Data

Connection type	screw connection
Number of poles	14
Plus switching contacts	2
Number of pole for rated current 2	0
Number of pole for rated current 3	0
Total number of poles (without ground contact)	16
With wire protection	yes
Min. conductor diameter rigid (solid/stranded)	0.5 mm ²
Max. conductor diameter rigid (solid/stranded)	2.5 mm ²
Protective contact	yes

Technical Data UL/CSA

Rated voltage according to UL/CSA	600 V
Rated current according UL	5 A
Rated current according CSA	16 A
Min. conductor cross section flexible wire	0.5 mm ²
Max. conductor cross section flexible wire	2.5 mm ²

Conductor cross section flexible AWG wire	22-12 AWG
---	-----------

Model

With housing	No
--------------	----

Contacts

Contact material	Copper alloy
Surface	Tin-plated
Contact resistance	≤ 1.5 mOhm
Wire strip length	7 mm

Screws head design/recomm. Torque

Mounting screws	H1/0.5-0.7 Nm
Clamping screws	H1/0.5-0.7 Nm
Ground conductor screws	H2/1.2-1.6 Nm

Technical Data DIN EN 61984

Nominal voltage	690 V
Rated voltage face/ground	690 V
Nominal current	16 A
Rated impulse voltage	8 kV

Classification

ECLASS 11	
ECLASS 8.1	27440205
ETIM 7.0	EC000438
ETIM 6.0	EC000438
ETIM 5.0	EC000438
ETIM 4.0	EC000438
ETIM 3.0	EC000438

Product compliance

ROHS conformity status	Compliant/Exempted
ROHS exceptions	III-6(c)
REACH-SVHC conformity status	Duty-To-Declare
REACH-SVHC substances	Lead
REACH-SVHC CAS numbers	7439-92-1

Fits with

Commercial Art.No.:	Article-type description:	Description:
72.700.1658.0	Female insert BAS BUC 16 69	Female insert revos basic, 16-poles, rated current: 16A, rated voltage:690V, with tin-plated contacts
71.350.1635.0	Hood BAS GOT GG 16 M25 A0	Hood revos basic made of aluminum, for single locking lever with cable gland M25 on the right side (IP54), low version, 16-poles
71.350.1635.1	Hood BAS GOT GG 16 M25 A1	Hood revos basic made of aluminum, for single locking lever with threaded hole M25 on the right side, low version, 16-poles
71.350.1635.2	Hood BAS GOT GG 16 M25 A2	Hood revos basic made of aluminum, for single locking lever with nozzleM25 on the right side, low version, 16-poles

71.350.1635.3	Hood BAS GOT GG 16 M25 A3	Hood revos basic made of aluminum, for single locking lever with trumpet gland M25 on the right side (IP54), low version, 16-poles
71.352.1635.0	Hood BAS GOT GI 16 M25 A0	Hood revos basic made of aluminum, for single locking lever with cable gland M25 on the top (IP54), low version, 16-poles
71.352.1635.1	Hood BAS GOT GI 16 M25 A1	Hood revos basic made of aluminum, for single locking lever with threaded hole M25 on the top, low version, 16-poles
71.352.1635.2	Hood BAS GOT GI 16 M25 A2	Hood revos basic made of aluminum, for single locking lever with nozzleM25 on the top, low version, 16-poles
71.352.1635.3	Hood BAS GOT GI 16 M25 A3	Hood revos basic made of aluminum, for single locking lever with trumpet gland M25 on the top (IP54), low version, 16-poles
71.353.1635.0	Hood BAS GOT GG 16 M32 A0	Hood revos basic made of aluminum, for single locking lever with cable gland M32 on the right side (IP54), low version, 16-poles
71.353.1635.1	Hood BAS GOT GG 16 M32 A1	Hood revos basic made of aluminum, for single locking lever with threaded hole M32 on the right side, low version, 16-poles
71.353.1635.2	Hood BAS GOT GG 16 M32 A2	Hood revos basic made of aluminum, for single locking lever with nozzleM32 on the right side, low version, 16-poles
71.354.1635.0	Hood BAS GOT GI 16 M32 A0	Hood revos basic made of aluminum, for single locking lever with cable gland M32 on the top (IP54), low version, 16-poles
71.354.1635.1	Hood BAS GOT GI 16 M32 A1	Hood revos basic made of aluminum, for single locking lever with threaded hole M32 on the top, low version, 16-poles
71.354.1635.2	Hood BAS GOT GI 16 M32 A2	Hood revos basic made of aluminum, for single locking lever with nozzleM32 on the top, low version, 16-poles
71.354.1635.3	Hood BAS GOT GI 16 M32 A3	Hood revos basic made of aluminum, for single locking lever with trumpet gland M32 on the top (IP54), low version, 16-poles
71.372.1635.0	Hood BAS GOT GL 16 M25 A0	Hood revos basic made of aluminum, with single locking lever and cable gland M25 on the top - free cable connection (IP54), low version, 16-poles
71.372.1635.1	Hood BAS GOT GL 16 M25 A1	Hood revos basic made of aluminum, with single locking lever and threaded hole M25 on the top - free cable connection, low version, 16-poles
71.372.1635.3	Hood BAS GOT GL 16 M25 A3	Hood revos basic made of aluminum, with single locking lever and trumpet gland M25 on the top - free cable connection (IP54), low version, 16-poles
71.450.1637.1	Hood BAS GOM GG16 M25 B1	Hood revos basic metal-series without coating, for single locking lever with threaded hole M25 on the right side, low version, 16-poles
71.452.1637.1	Hood BAS GOM GI16 M25 B1	Hood revos basic metal-series without coating, for single locking lever with threaded hole M25 on the top, low version, 16-poles
76.350.4035.0	Hood BAS GOT GG 40HM25 50 A0	Hood revos basic made of aluminum, for single locking lever with cable gland M25 on the right side (IP54), low version, 40-poles
76.350.4035.1	Hood BAS GOT GG 40HM25 50 A1	Hood revos basic made of aluminum, for single locking lever with threaded hole M25 on the right side, low version, 40-poles
76.350.4035.2	Hood BAS GOT GG 40HM25 50 A2	Hood revos basic made of aluminum, for single locking lever with nozzleM25 on the right side, low version, 40-poles
76.350.4035.3	Hood BAS GOT GG 16H M25 A3	Hood revos basic made of aluminum, for single locking lever with trumpet gland M25 on the right side (IP54), low version, 16-poles
76.351.1635.1	Hood BAS GOT GH 16H M20 A1	Hood revos basic made of aluminum, for single locking lever with threaded hole M20 on the front, low version, 16-poles
76.351.1635.3	Hood BAS GOT GH 10H M20 A3	Hood revos basic made of aluminum, for single locking lever with trumpet gland M20 on the front (IP54), low version, 10-poles
76.352.4035.0	Hood BAS GOT GI 40HM25 50 A0	Hood revos basic made of aluminum, for single locking lever with cable gland M25 on the top (IP54), low version, 40-poles
76.352.4035.1	Hood BAS GOT GI 16HM25 A1	Hood revos basic made of aluminum, for single locking lever with threaded hole M25 on the top, low version, 16-poles
76.352.4035.3	Hood BAS GOT GI 16H M25 A3	Hood revos basic made of aluminum, for single locking lever with trumpet gland M25 on the top (IP54), low version, 16-poles

76.353.4035.0	Hood BAS GOT GG 40HM32 50 A0	Hood revos basic made of aluminum, for single locking lever with cable gland M32 on the right side (IP54), low version, 40-poles
76.353.4035.1	Hood BAS GOT GG 16HM32 A1	Hood revos basic made of aluminum, for single locking lever with threaded hole M32 on the right side, low version, 16-poles
76.353.4035.2	Hood BAS GOT GG 40HM32 50 A2	Hood revos basic made of aluminum, for single locking lever with nozzleM32 on the right side, low version, 40-poles
76.353.4035.3	Hood BAS GOT GG 16H M32 A3	Hood revos basic made of aluminum, for single locking lever with trumpet gland M32 on the right side (IP54), low version, 16-poles
76.354.4035.0	Hood BAS GOT GI 40HM32 50 A0	Hood revos basic made of aluminum, for single locking lever with cable gland M32 on the top (IP54), low version, 40-poles
76.354.4035.1	Hood BAS GOT GI 40HM32 50 A1	Hood revos basic made of aluminum, for single locking lever with threaded hole M32 on the top, low version, 40-poles
76.354.4035.3	Hood BAS GOT GI 16H M32 A3	Hood revos basic made of aluminum, for single locking lever with trumpet gland M32 on the top (IP54), low version, 16-poles
76.360.4035.0	Hood BAS GOT GG 16H M40 A0	Hood revos basic made of aluminum, for single locking lever with cable gland M40 on the right side (IP54), low version, 16-poles
76.360.4035.1	Hood BAS GOT GG 40HM40 50 A1	Hood revos basic made of aluminum, for single locking lever with threaded hole M40 on the right side, low version, 40-poles
76.362.4035.1	Hood BAS GOT GI 40HM40 50 A1	Hood revos basic made of aluminum, for single locking lever with threaded hole M40 on the top, low version, 40-poles
76.374.4035.0	Hood BAS GOT GL 40HM32 50 A0	Connectors for free cable connections revos basic made of aluminum, with single locking lever and cable gland M32 on the top - free cable connection (IP54), 40-poles
71.320.1628.0	Bottom BAS GUT GK 16 A	Bottom-base revos basic made of aluminum, with single locking lever, open, low version, 16-poles
71.325.1628.0	Bottom BAS GUT GP 16 A	Bottom-base revos basic made of aluminum, with single locking lever, open, low version, 16-poles
71.330.1635.0	Bottom BAS GUT GL 16 M25 A0	Bottom-base revos basic made of aluminum, with single locking lever and cable gland M25 on the right and left side (IP54), low version, 16-polig
71.330.1635.1	Bottom BAS GUT GL 16 M25 A1	Bottom-base revos basic made of aluminum, with single locking lever and threaded hole M25 on the right and left side, low version, 16-polig
71.331.1635.0	Bottom BAS GUT GM 16 M25 A0	Bottom-base revos basic made of aluminum, with single locking lever and cable gland M25 on the left side (IP54), low version, 16-polig
71.331.1635.1	Bottom BAS GUT GM 16 M25 A1	Bottom-base revos basic made of aluminum, with single locking lever and threaded hole M25 on the left side, low version, 16-polig
71.333.1635.0	Bottom BAS GUT GO 16 M25 A0	Bottom-base revos basic made of aluminum, with single locking lever and cable gland M25 on the bottom (IP54), low version, 16-polig
71.333.1635.1	Bottom BAS GUT GO 16 M25 A1	Bottom-base revos basic made of aluminum, with single locking lever and threaded hole M25 on the bottom, low version, 16-polig
71.340.1635.0	Bottom BAS GUT GR 16 M25 A0	Bottom-base revos basic made of aluminum, with single locking lever and cable gland M25 on the right and the left side, with protective cover (IP54), low version, 16-polig
71.340.1635.1	Bottom BAS GUT GR 16 M25 A1	Bottom-base revos basic made of aluminum, with single locking lever and threaded hole M25 on the right and the left side, with protective cover, low version, 16-polig
71.341.1635.0	Bottom BAS GUT GS 16 M25 A0	Bottom-base revos basic made of aluminum, with single locking lever and cable gland M25 on the left side, with protective cover (IP54), low version, 16-polig
71.341.1635.1	Bottom BAS GUT GS 16 M25 A1	Bottom-base revos basic made of aluminum, with single locking lever and threaded hole M25 on the left side, with protective cover, low version, 16-polig
71.342.1635.0	Bottom BAS GUT GT 16 M25 A0	Bottom-base revos basic made of aluminum, with single locking lever and cable gland M25 on the right side, with protective cover (IP54), low version, 16-polig

71.342.1635.1	Bottom BAS GUT GT 16 M25 A1	Bottom-base revos basic made of aluminum, with single locking lever and threaded hole M25 on the right side, with protective cover, low version, 16-polig
71.343.1635.0	Bottom BAS GUT GU 16 M25 A0	Bottom-base revos basic made of aluminum, with single locking lever and cable gland M25 on the bottom, with protective cover (IP54), low version, 16-polig
71.343.1635.1	Bottom BAS GUT GU 16 M25 A1	Bottom-base revos basic made of aluminum, with single locking lever and threaded hole M25 on the bottom, with protective cover, low version, 16-polig
71.420.1637.0	Bottom BAS GUM GK 16 B	Bottom-base revos basic metal-series without coating, open, low version, 16-poles
71.425.1637.0	Bottom BAS GUM GP 16 B	Bottom-base revos basic metal-series without coating, with single locking lever and protective cover, low version, 16-poles
71.430.1637.1	Bottom BAS GUM GL 16 M25 B1	Bottom-base revos basic metal-series without coating, with single locking lever and threaded hole M25 on the right and left side, low version, 16-polig
71.431.1637.1	Bottom BAS GUM GM 16 M25 B1	Bottom-base revos basic metal-series without coating, with single locking lever and threaded hole M25 on the left side, low version, 16-polig
71.440.1637.1	Bottom BAS GUM GR 16 M25 B1	Bottom-base revos basic metal-series without coating, with single locking lever and threaded hole M25 on the right and the left side, with protective cover, low version, 16-polig
71.441.1637.1	Bottom BAS GUM GS 16 M25 B1	Bottom-base revos basic metal-series without coating, with single locking lever and threaded hole M25 on the left side, with protective cover, low version, 16-polig
76.330.4035.0	Bottom BAS GUT GL 40HM25 50 A0	Bottom-base revos basic made of aluminum, with single locking lever and cable gland M25 on the right and left side (IP54), low version, 40-polig
76.330.4035.1	Bottom BAS GUT GL 40HM25 50 A1	Bottom-base revos basic made of aluminum, with single locking lever and threaded hole M25 on the right and left side, low version, 40-polig
76.331.4035.0	Bottom BAS GUT GM 40HM25 50 A0	Bottom-base revos basic made of aluminum, with single locking lever and cable gland M25 on the left side (IP54), low version, 40-polig
76.331.4035.1	Bottom BAS GUT GM 40HM25 50 A1	Bottom-base revos basic made of aluminum, with single locking lever and threaded hole M25 on the left side, low version, 40-polig
76.333.4035.0	Bottom BAS GUT GO 40HM25 50 A0	Bottom-base revos basic made of aluminum, with single locking lever and cable gland M25 on the bottom (IP54), low version, 40-polig
76.333.4035.1	Bottom BAS GUT GO 40HM25 50 A1	Bottom-base revos basic made of aluminum, with single locking lever and threaded hole M25 on the bottom, low version, 40-polig
76.334.4035.1	Bottom BAS GUT GL 40HM32 50 A1	Bottom-base revos basic made of aluminum, with single locking lever and threaded hole M32 on the right and left side, low version, 40-polig
76.335.4035.0	Bottom BAS GUT GM 40HM32 50 A0	Bottom-base revos basic made of aluminum, with single locking lever and cable gland M32 on the left side (IP54), low version, 40-polig
76.335.4035.1	Bottom BAS GUT GM 40HM32 50 A1	Bottom-base revos basic made of aluminum, with single locking lever and threaded hole M32 on the left side, low version, 40-polig
76.337.4035.1	Bottom BAS GUT GO 40HM32 50 A1	Bottom-base revos basic made of aluminum, with single locking lever and threaded hole M32 on the bottom, low version, 40-polig
76.340.4035.0	Bottom BAS GUT GR 40HM25 50 A0	Bottom-base revos basic made of aluminum, with single locking lever and cable gland M25 on the right and the left side, with protective cover (IP54), low version, 40-polig
76.340.4035.1	Bottom BAS GUT GR 40HM25 50 A1	Bottom-base revos basic made of aluminum, with single locking lever and threaded hole M25 on the right and the left side, with protective cover, low version, 40-polig
76.341.4035.0	Bottom BAS GUT GS 40HM25 50 A0	Bottom-base revos basic made of aluminum, with single locking lever and cable gland M25 on the left side, with protective cover (IP54), low version, 40-polig

76.341.4035.1	Bottom BAS GUT GS 40HM25 50 A1	Bottom-base revos basic made of aluminum, with single locking lever and threaded hole M25 on the left side, with protective cover, low version, 40-polig
76.344.4035.0	Bottom BAS GUT GR 40HM32 50 A0	Bottom-base revos basic made of aluminum, with single locking lever and cable gland M32 on the right and the left side, with protective cover (IP54), low version, 40-polig
76.344.4035.1	Bottom BAS GUT GR 40HM32 50 A1	Bottom-base revos basic made of aluminum, with single locking lever and threaded hole M32 on the right and the left side, with protective cover, low version, 40-polig
76.345.4035.0	Bottom BAS GUT GS 16HM32 A0	Bottom-base revos basic made of aluminum, with single locking lever and cable gland M32 on the left side, with protective cover (IP54), low version, 16-polig
76.345.4035.1	Bottom BAS GUT GS 40HM32 50 A1	Bottom-base revos basic made of aluminum, with single locking lever and threaded hole M32 on the left side, with protective cover, low version, 40-polig
76.346.4035.0	Bottom BAS GUT GT 40HM32 50 A0	Bottom-base revos basic made of aluminum, with single locking lever and cable gland M32 on the right side, with protective cover (IP54), low version, 40-polig
76.346.4035.1	Bottom BAS GUT GT 40HM32 50 A1	Bottom-base revos basic made of aluminum, with single locking lever and threaded hole M32 on the right side, with protective cover, low version, 40-polig
76.347.4035.0	Bottom BAS GUT GU 40HM32 50 A0	Bottom-base revos basic made of aluminum, with single locking lever and cable gland M32 on the bottom, with protective cover (IP54), low version, 40-polig
76.347.4035.1	Bottom BAS GUT GU 40HM32 50 A1	Bottom-base revos basic made of aluminum, with single locking lever and threaded hole M32 on the bottom, with protective cover, low version, 40-polig
70.350.1635.0	Hood BAS GOT GA 16 M25 A0	Hood revos basic made of aluminum, for double locking lever or. screw cap with cable gland M25 on the right side (IP54), low version, 16-poles
70.350.1635.1	Hood BAS GOT GA 16 M25 A1	Hood revos basic made of aluminum, for double locking lever or. screw cap with threaded hole M25 on the right side, low version, 16-poles
70.350.1635.2	Hood BAS GOT GA 16 M25 A2	Hood revos basic made of aluminum, for double locking lever or. screw cap with nozzle M25 on the right side, low version, 16-poles
70.350.1635.3	Hood BAS GOT GA 16 M25 A3	Hood revos basic made of aluminum, for double locking lever or. screw cap with trumpet gland M25 on the right side (IP54), low version, 16-poles
70.352.1635.0	Hood BAS GOT GC 16 M25 A0	Hood revos basic made of aluminum, for double locking lever or. screw cap with cable gland M25 on the top (IP54), low version, 16-poles
70.352.1635.1	Hood BAS GOT GC 16 M25 A1	Hood revos basic made of aluminum, for double locking lever or. screw cap with threaded hole M25 on the top, low version, 16-poles
70.352.1635.2	Hood BAS GOT GC 16 M25 A2	Hood revos basic made of aluminum, for double locking lever or. screw cap with nozzle M25 on the top, low version, 16-poles
70.352.1635.3	Hood BAS GOT GC 16 M25 A3	Hood revos basic made of aluminum, for double locking lever or. screw cap with trumpet gland M25 on the top (IP54), low version, 16-poles
70.353.1635.0	Hood BAS GOT GA 16 M32 A0	Hood revos basic made of aluminum, for double locking lever or. screw cap with cable gland M32 on the right side (IP54), low version, 16-poles
70.353.1635.1	Hood BAS GOT GA 16 M32 A1	Hood revos basic made of aluminum, for double locking lever or. screw cap with threaded hole M32 on the right side, low version, 16-poles
70.353.1635.2	Hood BAS GOT GA 16 M32 A2	Hood revos basic made of aluminum, for double locking lever or. screw cap with nozzle M32 on the right side, low version, 16-poles

70.353.1635.3	Hood BAS GOT GA 16 M32 A3	Hood revos basic made of aluminum, for double locking lever or. screw cap with trumpet gland M32 on the right side (IP54), low version, 16-poles
70.354.1635.0	Hood BAS GOT GC 16 M32 A0	Hood revos basic made of aluminum, for double locking lever or. screw cap with cable gland M32 on the top (IP54), low version, 16-poles
70.354.1635.1	Hood BAS GOT GC 16 M32 A1	Hood revos basic made of aluminum, for double locking lever or. screw cap with threaded hole M32 on the top, low version, 16-poles
70.354.1635.3	Hood BAS GOT GC 16 M32 A3	Hood revos basic made of aluminum, for double locking lever or. screw cap with trumpet gland M32 on the top (IP54), low version, 16-poles
70.355.1635.0	Hood BAS GOT GD 16 M25 A0	Hood revos basic made of aluminum, with double locking lever and cable gland M25 on the right side (IP54), low version, 16-poles
70.355.1635.1	Hood BAS GOT GD 16 M25 A1	Hood revos basic made of aluminum, with double locking lever and threaded hole M25 on the right side, low version, 16-poles
70.355.1635.2	Hood BAS GOT GD 16 M25 A2	Hood revos basic made of aluminum, with double locking lever and nozzle M25 on the right side, low version, 16-poles
70.355.1635.3	Hood BAS GOT GD 16 M25 A3	Hood revos basic made of aluminum, with double locking lever and trumpet gland M25 on the right side (IP54), low version, 16-poles
70.357.1635.0	Hood BAS GOT GF 16 M25 A0	Hood revos basic made of aluminum, with double locking lever and cable gland M25 on the top (IP54), low version, 16-poles
70.357.1635.1	Hood BAS GOT GF 16 M25 A1	Hood revos basic made of aluminum, with double locking lever and threaded hole M25 on the top, low version, 16-poles
70.357.1635.3	Hood BAS GOT GF 16 M25 A3	Hood revos basic made of aluminum, with double locking lever and trumpet gland M25 on the top (IP54), low version, 16-poles
70.358.1635.0	Hood BAS GOT GD 16 M32 A0	Hood revos basic made of aluminum, with double locking lever and cable gland M32 on the right side (IP54), low version, 16-poles
70.358.1635.1	Hood BAS GOT GD 16 M32 A1	Hood revos basic made of aluminum, with double locking lever and threaded hole M32 on the right side, low version, 16-poles
70.358.1635.3	Hood BAS GOT GD 16 M32 A3	Hood revos basic made of aluminum, with double locking lever and trumpet gland M32 on the right side (IP54), low version, 16-poles
70.359.1635.0	Hood BAS GOT GF 16 M32 A0	Hood revos basic made of aluminum, with double locking lever and cable gland M32 on the top (IP54), low version, 16-poles
70.359.1635.1	Hood BAS GOT GF 16 M32 A1	Hood revos basic made of aluminum, with double locking lever and threaded hole M32 on the top, low version, 16-poles
70.359.1635.3	Hood BAS GOT GF 16 M32 A3	Hood revos basic made of aluminum, with double locking lever and trumpet gland M32 on the top (IP54), low version, 16-poles
70.372.1635.0	Hood BAS GOT GK 16 M25 A0	Hood revos basic made of aluminum, with double locking lever and cable gland M25 on the top - free cable connection (IP54), low version, 16-poles
70.372.1635.1	Hood BAS GOT GK 16 M25 A1	Hood revos basic made of aluminum, with double locking lever and threaded hole M25 on the top - free cable connection, low version, 16-poles
70.372.1635.3	Hood BAS GOT GK 16 M25 A3	Hood revos basic made of aluminum, with double locking lever and trumpet gland M25 on the top - free cable connection (IP54), low version, 16-poles
72.250.1635.2	Hood POW GOT GA 16 M40 69 A2	Hood revos basic made of aluminum, for double locking lever or. screw cap with nozzle M40 on the right side, low version, 16-poles
73.350.4035.0	Hood BAS GOT GA 16HM25 50 A0	Hood revos basic made of aluminum, for double locking lever or. screw cap with cable gland M25 on the right side (IP54), low version, 16-poles
73.350.4035.1	Hood BAS GOT GA 16HM25 50 A1	Hood revos basic made of aluminum, for double locking lever or. screw cap with threaded hole M25 on the right side, low version, 16-poles
73.350.4035.2	Hood BAS GOT GA 16HM25 50 A2	Hood revos basic made of aluminum, for double locking lever or. screw cap with nozzle M25 on the right side, low version, 16-poles

73.350.4035.3	Hood BAS GOT GA 16H M25 A3	Hood revos basic made of aluminum, for double locking lever or. screw cap with trumpet gland M25 on the right side (IP54), low version, 16-poles
73.351.1635.1	Hood BAS GOT GB 16H M25 A1	Hood revos basic made of aluminum, for double locking lever and threaded hole M25 on the front, low version, 16-poles
73.351.1635.3	Hood BAS GOT GB 16H M25 A3	Hood revos basic made of aluminum, for double locking lever and trumpetgland M25 on the front (IP54), low version, 16-poles
73.352.4035.0	Hood BAS GOT GC 16HM25 50 A0	Hood revos basic made of aluminum, for double locking lever or. screw cap with cable gland M25 on the top (IP54), low version, 16-poles
73.352.4035.1	Hood BAS GOT GC 16HM25 50 A1	Hood revos basic made of aluminum, for double locking lever or. screw cap with threaded hole M25 on the top, low version, 16-poles
73.352.4035.2	Hood BAS GOT GC 16HM25 50 A2	Hood revos basic made of aluminum, for double locking lever or. screw cap with nozzle M25 on the top, low version, 16-poles
73.352.4035.3	Hood BAS GOT GC 16H M25 A3	Hood revos basic made of aluminum, for double locking lever or. screw cap with trumpet gland M25 on the top (IP54), low version, 16-poles
73.353.4035.0	Hood BAS GOT GA 40HM32 50 A0	Hood revos basic made of aluminum, for double locking lever or. screw cap with cable gland M32 on the right side (IP54), high version, 40- poles
73.353.4035.1	Hood BAS GOT GA 40HM32 50 A1	Hood revos basic made of aluminum, for double locking lever or. screw cap with threaded hole M32 on the right side, low version, 40-poles
73.353.4035.2	Hood BAS GOT GA 40HM32 50 A2	Hood revos basic made of aluminum, for double locking lever or. screw cap with nozzle M32 on the right side, low version, 40-poles
73.353.4035.3	Hood BAS GOT GA 16HM32 A3	Hood revos basic made of aluminum, for double locking lever or. screw cap with trumpet gland M32 on the right side (IP54), low version, 16-poles
73.354.4035.0	Hood BAS GOT GC 16HM32 50 A0	Hood revos basic made of aluminum, for double locking lever or. screw cap with cable gland M32 on the top (IP54), low version, 16-poles
73.354.4035.1	Hood BAS GOT GC 16HM32 50 A1	Hood revos basic made of aluminum, for double locking lever or. screw cap with threaded hole M32 on the top, low version, 16-poles
73.354.4035.2	Hood BAS GOT GC 16HM32 50 A2	Hood revos basic made of aluminum, for double locking lever or. screw cap with nozzle M32 on the top, low version, 16-poles
73.354.4035.3	Hood BAS GOT GC 16HM32 A2	Hood revos basic made of aluminum, for double locking lever or. screw cap with nozzle M32 on the top, low version, 16-poles
73.355.4035.1	Hood BAS GOT GD 16HM25 50 A1	Hood revos basic made of aluminum, with double locking lever and threaded hole M25 on the right side, low version, 16-poles
73.357.4035.0	Hood BAS GOT GF 16HM25 50 A0	Hood revos basic made of aluminum, with double locking lever and cable gland M25 on the top (IP54), low version, 16-poles
73.357.4035.1	Hood BAS GOT GF 16HM25 50 A1	Hood revos basic made of aluminum, with double locking lever and threaded hole M25 on the top, low version, 16-poles
73.357.4035.2	Hood BAS GOT GF 16HM25 50 A2	Hood revos basic made of aluminum, with double locking lever and nozzleM25 on the top, low version, 16-poles
73.358.4035.0	Hood BAS GOT GD 16HM32 50 A0	Hood revos basic made of aluminum, with double locking lever and cable gland M32 on the right side (IP54), low version, 16-poles
73.358.4035.1	Hood BAS GOT GD 16HM32 50 A1	Hood revos basic made of aluminum, with double locking lever and threaded hole M32 on the right side, low version, 16-poles
73.359.4035.0	Hood BAS GOT GF 16HM32 50 A0	Hood revos basic made of aluminum, with double locking lever and cable gland M32 on the top (IP54), low version, 16-poles
73.359.4035.1	Hood BAS GOT GF 16HM32 50 A1	Hood revos basic made of aluminum, with double locking lever and threaded hole M32 on the top, high version, 16-poles
73.359.4035.2	Hood BAS GOT GF 16HM32 50 A2	Hood revos basic made of aluminum, with double locking lever and nozzleM32 on the top, low version, 16-poles

73.359.4035.3	Hood BAS GOT GF 16HM32 A3	Hood revos basic made of aluminum, with double locking lever and trumpet gland M32 on the top (IP54), low version, 16-poles
73.360.4035.0	Hood BAS GOT GA 16HM40 A0	Hood revos basic made of aluminum, for double locking lever or screw cap with cable gland M40 on the right side (IP54), low version, 16-poles
73.360.4035.1	Hood BAS GOT GA 16HM40 50 A1	Hood revos basic made of aluminum, for double locking lever or screw cap with threaded hole M40 on the right side, low version, 16-poles
73.362.4035.1	Hood BAS GOT GC 16HM40 50 A1	Hood revos basic made of aluminum, for double locking lever or screw cap with threaded hole M40 on the top, low version, 16-poles
70.320.1628.0	Bottom BAS GUT GA 16 A	Bottom-base revos basic made of aluminum, with double locking lever or screw cap, low version, 16-poles
70.325.1628.0	Bottom BAS GUT GE 16 A	Bottom-base revos basic made of aluminum, for double locking lever and protective cover, open, low version, 16-poles
70.330.1635.0	Bottom BAS GUT GB 16 M25 A0	Bottom-base revos basic made of aluminum, with double locking lever or screw cap with cable gland M25 on the right and left side (IP54), low version, 16-polig
70.330.1635.1	Bottom BAS GUT GB 16 M25 A1	Bottom-base revos basic made of aluminum, with double locking lever or screw cap with threaded hole M25 on the right and left side, low version, 16-polig
70.331.1635.0	Bottom BAS GUT GC 16 M25 A0	Bottom-base revos basic made of aluminum, with double locking lever or screw cap with cable gland M25 on the left side (IP54), low version, 16-polig
70.331.1635.1	Bottom BAS GUT GC 16 M25 A1	Bottom-base revos basic made of aluminum, with double locking lever or screw cap with threaded hole M25 on the left side, low version, 16-polig
70.333.1635.0	Bottom BAS GUT GD 16 M25 A0	Bottom-base revos basic made of aluminum, with double locking lever or screw cap with cable gland M25 on the right side (IP54), low version, 16-polig
70.333.1635.1	Bottom BAS GUT GD 16 M25 A1	Bottom-base revos basic made of aluminum, with double locking lever or screw cap with threaded hole M25 on the right side, low version, 16-polig
70.340.1635.0	Bottom BAS GUT GF 16 M25 A0	Bottom-base revos basic made of aluminum, for double locking lever with cable gland M25 on the left and right side, with protective cover (IP54), low version, 16-polig
70.340.1635.1	Bottom BAS GUT GF 16 M25 A1	Bottom-base revos basic made of aluminum, for double locking lever with threaded hole M25 on the left and right side, with protective cover, low version, 16-polig
70.341.1635.0	Bottom BAS GUT GG 16 M25 A0	Bottom-base revos basic made of aluminum, with double locking lever and cable gland M25 on the left side, with protective cover (IP54), low version, 16-polig
70.341.1635.1	Bottom BAS GUT GG 16 M25 A1	Bottom-base revos basic made of aluminum, with double locking lever and threaded hole M25 on the left side, with protective cover, low version, 16-polig
70.342.1635.0	Bottom BAS GUT GH 16 M25 A0	Bottom-base revos basic made of aluminum, with double locking lever and cable gland M25 on the right side, with protective cover (IP54), low version, 16-polig
70.342.1635.1	Bottom BAS GUT GH 16 M25 A1	Bottom-base revos basic made of aluminum, with double locking lever and threaded hole M25 on the right side, with protective cover, low version, 16-polig
70.343.1635.0	Bottom BAS GUT GI 16 M25 A0	Bottom-base revos basic made of aluminum, with double locking lever and cable gland M25 on the bottom, with protective cover (IP54), low version, 16-polig
70.343.1635.1	Bottom BAS GUT GI 16 M25 A1	Bottom-base revos basic made of aluminum, with double locking lever and threaded hole M25 on the bottom, with protective cover, low version, 16-polig

73.330.4035.0	Bottom BAS GUT GB 16HM25 50 A0	Bottom-base revos basic made of aluminum, with double locking lever or.screw cap with cable gland M25 on the right and left side (IP54), low version, 16-polig
73.330.4035.1	Bottom BAS GUT GB 16HM25 50 A1	Bottom-base revos basic made of aluminum, with double locking lever or.screw cap with threaded hole M25 on the right and left side, low version, 16-polig
73.331.4035.0	Bottom BAS GUT GC 16HM25 50 A0	Bottom-base revos basic made of aluminum, with double locking lever or.screw cap with cable gland M25 on the left side (IP54), low version, 16-polig
73.331.4035.1	Bottom BAS GUT GC 16M25 50 A1	Bottom-base revos basic made of aluminum, with double locking lever or.screw cap with threaded hole M25 on the left side, low version, 16-polig
73.333.4035.0	Bottom BAS GUT GD 16HM25 50 A0	Bottom-base revos basic made of aluminum, with double locking lever or.screw cap with cable gland M25 on the right side (IP54), low version, 16-polig
73.333.4035.1	Bottom BAS GUT GD 16HM25 50 A1	Bottom-base revos basic made of aluminum, with double locking lever or.screw cap with threaded hole M25 on the right side, low version, 16-polig
73.334.4035.0	Bottom BAS GUT GB 16HM32 50 A0	Bottom-base revos basic made of aluminum, with double locking lever or.screw cap with cable gland M32 on the right and left side (IP54), low version, 16-polig
73.334.4035.1	Bottom BAS GUT GB 16HM32 50 A1	Bottom-base revos basic made of aluminum, with double locking lever or.screw cap with threaded hole M32 on the right and left side, low version, 16-polig
73.335.4035.0	Bottom BAS GUT GC 16HM32 50 A0	Bottom-base revos basic made of aluminum, with double locking lever or.screw cap with cable gland M32 on the left side (IP54), high version, 6-poles
73.335.4035.1	Bottom BAS GUT GC 16HM32 50 A1	Bottom-base revos basic made of aluminum, with double locking lever or.screw cap with threaded hole M32 on the left side, low version, 16-polig
73.337.4035.0	Bottom BAS GUT GD 16HM32 50 A0	Bottom-base revos basic made of aluminum, with double locking lever or.screw cap with cable gland M32 on the right side (IP54), low version, 16-polig
73.337.4035.1	Bottom BAS GUT GD 16HM32 50 A1	Bottom-base revos basic made of aluminum, with double locking lever or.screw cap with threaded hole M32 on the right side, low version, 16-polig
73.338.4035.1	Bottom BAS GUT GB 16H M40 A1	Bottom-base revos basic made of aluminum, with double locking lever or.screw cap with threaded hole M40 on the right and left side, low version, 16-polig
73.339.4035.1	Bottom BAS GUT GC 16H M40 A1	Bottom-base revos basic made of aluminum, with double locking lever or.screw cap with threaded hole M40 on the left side, low version, 16-polig
73.340.4035.0	Bottom BAS GUT GB 16H M40 A1	Bottom-base revos basic made of aluminum, with double locking lever or.screw cap with threaded hole M40 on the right and left side, low version, 16-polig
73.340.4035.1	Bottom BAS GUT GF 16HM25 50 A1	Bottom-base revos basic made of aluminum, for double locking lever with threaded hole M25 on the left and right side, with protective cover, low version, 16-polig
73.341.4035.0	Bottom BAS GUT GC 16H M40 A1	Bottom-base revos basic made of aluminum, with double locking lever or.screw cap with threaded hole M40 on the left side, low version, 16-polig
73.341.4035.1	Bottom BAS GUT GG 16HM25 50 A1	Bottom-base revos basic made of aluminum, with double locking lever and threaded hole M25 on the left side, with protective cover, low version, 16-polig
73.342.4035.1	Bottom BAS GUT GH 16HM25 50 A1	Bottom-base revos basic made of aluminum, with double locking lever and threaded hole M25 on the right side, with protective cover, low version, 16-polig

73.344.4035.0	Bottom BAS GUT GF 16HM32 50 A0	Bottom-base revos basic made of aluminum, for double locking lever with cable gland M32 on the left and right side, with protective cover (IP54), low version, 16-polig
73.344.4035.1	Bottom BAS GUT GF 16HM32 50 A1	Bottom-base revos basic made of aluminum, for double locking lever with threaded hole M32 on the left and right side, with protective cover, high version, 16-polig
73.345.4035.0	Bottom BAS GUT GG 16HM32 50 A0	Bottom-base revos basic made of aluminum, with double locking lever and cable gland M32 on the left side, with protective cover (IP54), low version, 16-polig
73.345.4035.1	Bottom BAS GUT GG 16HM32 50 A1	Bottom-base revos basic made of aluminum, with double locking lever and threaded hole M32 on the left side, with protective cover, low version, 16-polig
73.346.4035.0	Bottom BAS GUT GH 16HM32 50 A0	Bottom-base revos basic made of aluminum, with double locking lever and cable gland M32 on the right side, with protective cover (IP54), low version, 16-polig
73.346.4035.1	Bottom BAS GUT GH 16HM32 50 A1	Bottom-base revos basic made of aluminum, with double locking lever and threaded hole M32 on the right side, with protective cover, low version, 16-polig
73.347.4035.0	Bottom BAS GUT GI 16HM32 50 A0	Bottom-base revos basic made of aluminum, with double locking lever and cable gland M32 on the bottom, with protective cover (IP54), low version, 16-polig
73.347.4035.1	Bottom BAS GUT GI 40HM32 50 A1	Bottom-base revos basic made of aluminum, with double locking lever and threaded hole M32 on the bottom, with protective cover, low version, 40-polig
72.300.1653.0	Female insert BAS BUS 16 2,5 69	Female insert revos basic, 16-poles, rated current: 16A, rated voltage: 690V, with tin-plated contacts

A Weitergabe sowie Vervielfältigung dieses Dokuments, Verwertung und Mitteilung seines Inhalts sind verboten, soweit nicht ausdrücklich gestattet. The reproduction, distribution and utilization of this document as well as the communication of its contents to others without express authorization is prohibited.

B These dimensions will be especially checked at delivery Only inspection dimensions With /E marked dimensions are only valid for internal use

D Diese Maße werden bei Abnahme besonders geprüft Ausschließlich Prüfmaße Mit /E gekennzeichnete Maße sind nur für interne Zwecke gültig

F

gezeichnete Ausführung: 10-polig
drawn version: 10-pole insert

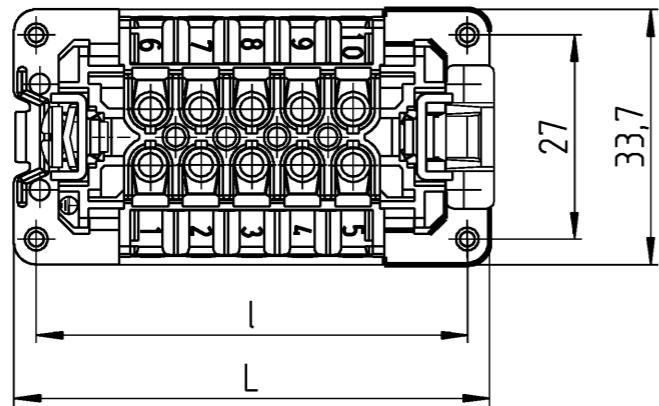
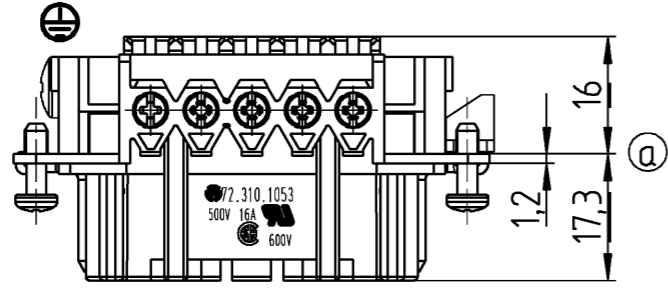

Schutzleiter
earth conductor

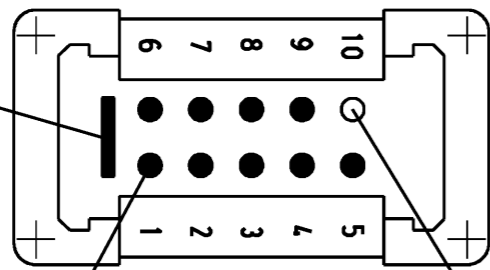

2x Z5.553.3521.0
Schaltkontakte/switch contact
6-polig bei Pol 1 u. 6
10-polig bei Pol 1 u. 10
16-polig bei Pol 1 u. 16
24-polig bei Pol 1 u. 24

4 Ausführung/
version:
6-polig
6-pole

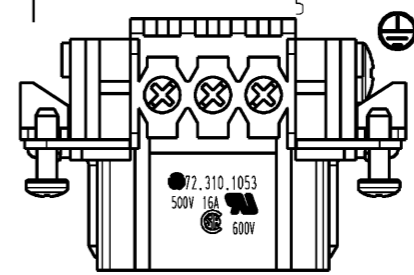

Ausführung/
version:
16-polig
16-pole

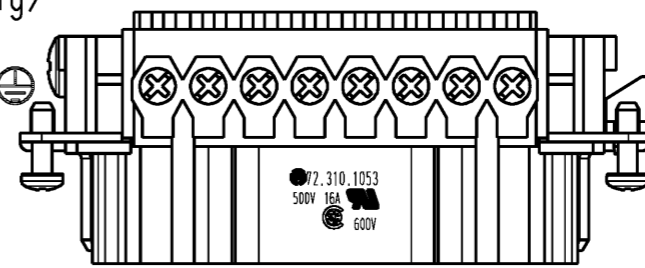

Ausführung/
version:
24-polig
24-pole

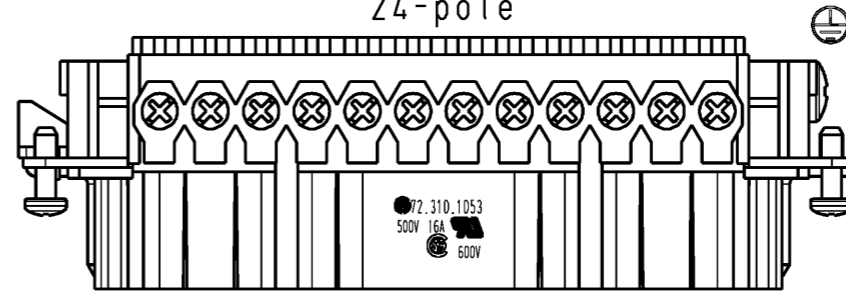

Weitere Daten siehe Katalog
further data see catalog

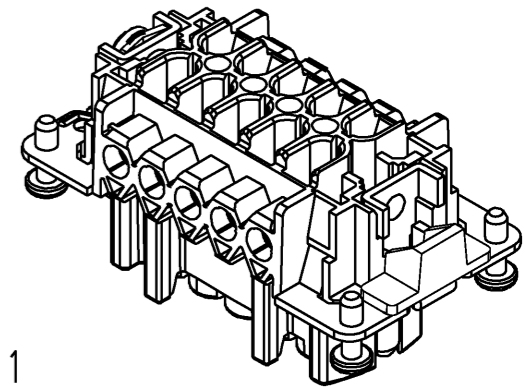

1:1

Teile-Nr. part no.	Maß dimension	
	L	I
72.310.0653.0	49,8	44
72.310.1053.0	62,8	57
72.310.1653.0	83,3	77,5
72.310.2453.0	109,8	104

Tolerierung Size ISO 14405 (E) / Tolerance system Size ISO 14405 (E). ja/yes Stoffverbots- und Deklarationsliste nach WN 5020.010 ist einzuhalten. (This ISO-standard describes the envelope principle. According to the envelope principle the deviations of form and parallelism are limited by the size tolerances.) Conformity with Wieland document WN 5020.010 e (list of prohibited / declarable hazardous substances) to be declared!

Freitoleranz nach General tolerance CAD - Zeichnung, keine manuellen Änderungen CAD - drawing, no manual modifications allowed 1. Verwendung: First Use: Blatt: 1 von 1 Sheet: 1 of 1

		Werkstoff / Material		Tag/Date	Name	Zeichnung Nr. / Drawing No.		Index		
		Maßstab / Scale		gezeichnet drawn	03.05.2012	Schmitt J.	T 72.310.0653.0 01K	a		
		1:1		geprüft checked					Maße in mm / Dimensions are in mm	
		Vol. mm ³ / fl./Srf. mm ²		Normgepr. Stand. check	Ersatz für / Replacement for:					
a 23.08.2017 /		www.wieland		Type		Benennung/Title				
Index Datum / Blatt Date / Sheet		www.wieland-electric.com				Steckereinsatz				
Änderung / Revision						6,10,16 u. 24 pol. STS 2,5 690V 16A male insert 6, 10, 16, 24 pole version				

6 Weitergabe sowie Vervielfältigung dieses Dokuments, Verwertung und Mitteilung seines Inhalts sind verboten, soweit nicht ausdrücklich gestattet. The reproduction, distribution and utilization of this document as well as the communication of its contents to others without express authorization is prohibited.