

High Voltage Ultrafast Rectifier

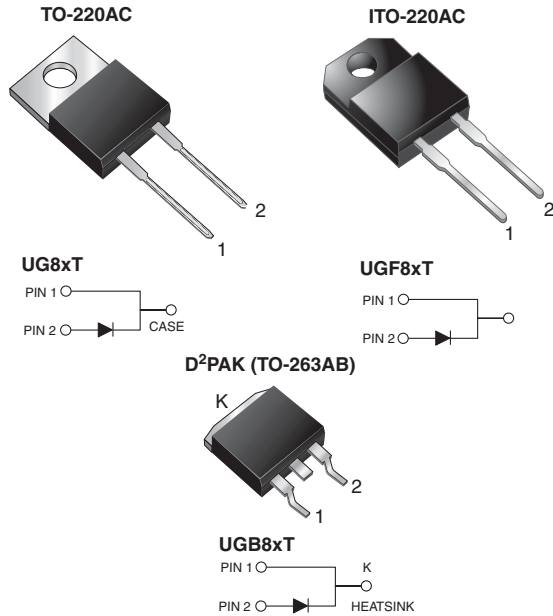

FEATURES

- Power pack
- Glass passivated chip junction
- Ultrafast recovery time
- Soft recovery characteristics
- Low switching losses, high efficiency
- High forward surge capability
- Meets MSL level 1, per J-STD-020, LF maximum peak of 245 °C (for TO-263AB package)
- Solder dip 275 °C max., 10 s per JESD 22-B106 (for TO-220AC and ITO-220AC package)
- AEC-Q101 qualified
- Material categorization: for definitions of compliance please see www.vishay.com/doc?99912



RoHS
COMPLIANT

TYPICAL APPLICATIONS

For use in high voltage and high frequency power factor correction application.

MECHANICAL DATA

Case: TO-220AC, ITO-220AC, D²PAK (TO-263AB)

Molding compound meets UL 94V-0 flammability rating
Base P/N-E3 - RoHS-compliant, commercial grade
Base P/NHE3 - RoHS-compliant, AEC-Q101 qualified

Terminals: matte tin plated leads, solderable per J-STD-002 and JESD22-B102

E3 suffix meets JESD 201 class 1A whisker test, HE3 suffix meets JESD 201 class 2 whisker test

Polarity: as marked

Mounting Torque: 10 in-lbs max.

DESIGN SUPPORT TOOLS

[click logo to get started](#)

3D
Models
Available

PRIMARY CHARACTERISTICS	
$I_{F(AV)}$	8.0 A
V_{RRM}	500 V to 600 V
I_{FSM}	100 A
t_{rr}	25 ns
t_{fr}	500 ns
V_F at $I_F = 8$ A	1.5 V
T_J max.	150 °C
Package	TO-220AC, ITO-220AC, D ² PAK (TO-263AB)
Circuit configuration	Single

MAXIMUM RATINGS ($T_C = 25$ °C unless otherwise noted)				
PARAMETER	SYMBOL	UG8HT	UG8JT	UNIT
Max. repetitive peak reverse voltage	V_{RRM}	500	600	V
Max. working reverse voltage	V_{RWM}	400	480	V
Max. RMS voltage	V_{RMS}	350	420	V
Max. DC blocking voltage	V_{DC}	500	600	V
Max. average forward rectified current	$I_{F(AV)}$	8.0		A
Peak forward surge current 8.3 ms single half sine-wave superimposed on rated load	I_{FSM}	100		A
Operating junction and storage temperature range	T_J, T_{STG}	-55 to +150		°C
Isolation voltage (ITO-220AB only) from terminals to heatsink $t = 1$ min	V_{AC}	1500		V



ELECTRICAL CHARACTERISTICS ($T_C = 25\text{ }^\circ\text{C}$ unless otherwise noted)						
PARAMETER	TEST CONDITIONS		SYMBOL	UG8HT	UG8JT	UNIT
Max. instantaneous forward voltage ⁽¹⁾	$I_F = 8\text{ A}$	$T_J = 25\text{ }^\circ\text{C}$	V_F	1.75		V
	$I_F = 8\text{ A}$	$T_J = 125\text{ }^\circ\text{C}$		1.50		
Max. DC reverse current at V_{RWM}	$T_J = 25\text{ }^\circ\text{C}$		I_R	30		μA
	$T_J = 100\text{ }^\circ\text{C}$			800		μA
	$T_J = 125\text{ }^\circ\text{C}$			4.0		mA
Max. reverse recovery time	$I_F = 0.5\text{ A}$, $I_R = 1.0\text{ A}$, $I_{rr} = 0.25\text{ A}$		t_{rr}	25		ns
	$I_F = 1.0\text{ A}$, $dI/dt = 50\text{ A}/\mu\text{s}$, $V_R = 30\text{ V}$, $I_{rr} = 0.1 I_{RM}$		t_{rr}	50		ns
Typical softness factor (t_b/t_a)	$I_F = 8.0\text{ A}$, $dI/dt = 240\text{ A}/\mu\text{s}$, $V_R = 400\text{ V}$, $I_{rr} = 0.1 I_{RM}$		S	1.0		-
Max. reverse recovery current	$I_F = 8.0\text{ A}$, $dI/dt = 64\text{ A}/\mu\text{s}$, $V_R = 400\text{ V}$, $T_C = 125\text{ }^\circ\text{C}$		I_{RM}	5.5		A
	$I_F = 8.0\text{ A}$, $dI/dt = 240\text{ A}/\mu\text{s}$, $V_R = 400\text{ V}$, $T_C = 125\text{ }^\circ\text{C}$		I_{RM}	10		A
Peak forward recovery time	$I_F = 8.0\text{ A}$, $dI/dt = 64\text{ A}/\mu\text{s}$, $V_F = 1.1 \times V_{F\text{ max.}}$		t_{fr}	500		ns

Note⁽¹⁾ Pulse test: 300 μs pulse width, 1 % duty cycle

THERMAL CHARACTERISTICS ($T_C = 25\text{ }^\circ\text{C}$ unless otherwise noted)					
PARAMETER	SYMBOL	UG8	UGF	UGB8	UNIT
Typical thermal resistance from junction to case	$R_{\theta JC}$	2.2	5.0	2.2	$^\circ\text{C}/\text{W}$

ORDERING INFORMATION (Example)					
PACKAGE	PREFERRED P/N	UNIT WEIGHT (g)	PACKAGE CODE	BASE QUANTITY	DELIVERY MODE
TO-220AC	UG8JT-E3/45	1.80	45	50/tube	Tube
ITO-220AC	UGF8JT-E3/45	1.95	45	50/tube	Tube
TO-263AB	UGB8JT-E3/45	1.33	45	50/tube	Tube
TO-263AB	UGB8JT-E3/81	1.33	81	800/reel	Tape and reel
TO-220AC	UG8JT ^{THE3} /45 ⁽¹⁾	1.80	45	50/tube	Tube
ITO-220AC	UGF8JT ^{THE3} /45 ⁽¹⁾	1.95	45	50/tube	Tube
TO-263AB	UGB8JT ^{THE3} /45 ⁽¹⁾	1.33	45	50/tube	Tube
TO-263AB	UGB8JT ^{THE3} /81 ⁽¹⁾	1.33	81	800/reel	Tape and reel

Note⁽¹⁾ AEC-Q101 qualified



RATINGS AND CHARACTERISTICS CURVES ($T_A = 25\text{ }^\circ\text{C}$ unless otherwise noted)

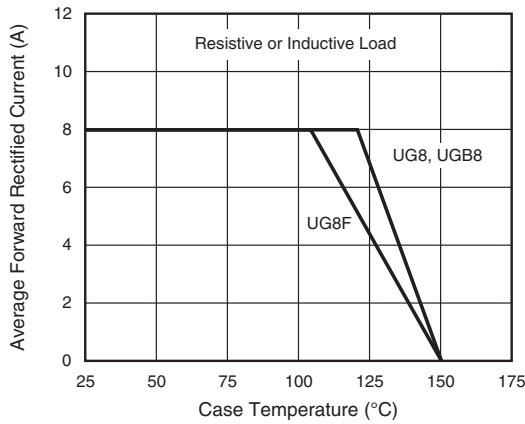

Fig. 1 - Max. Forward Current Derating Curve

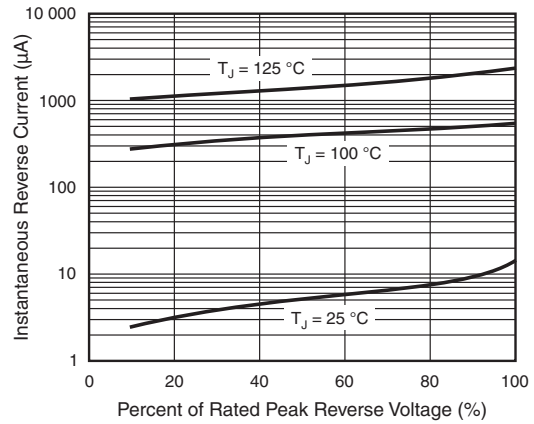

Fig. 4 - Typical Reverse Leakage Characteristics

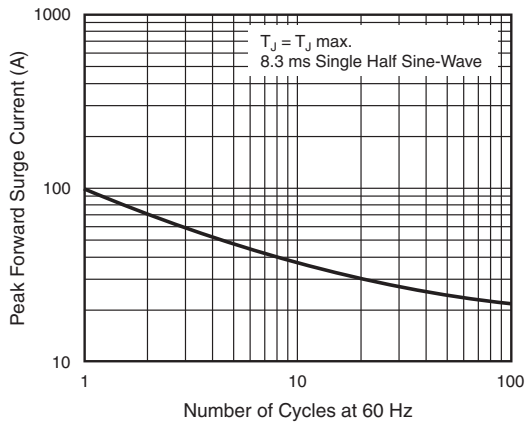

Fig. 2 - Max. Non-Repetitive Peak Forward Surge Current

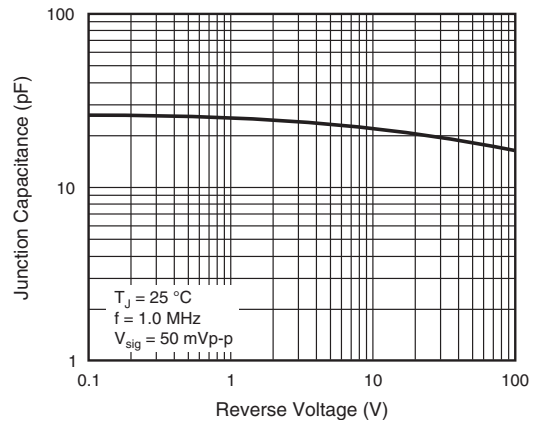

Fig. 5 - Typical Junction Capacitance

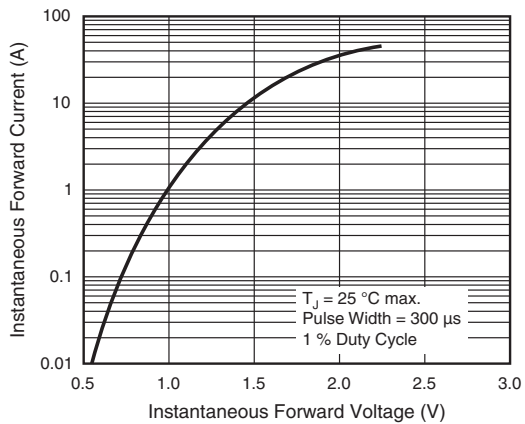

Fig. 3 - Typical Instantaneous Forward Characteristics

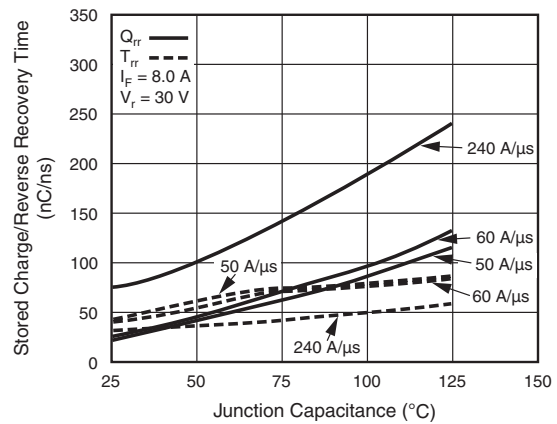
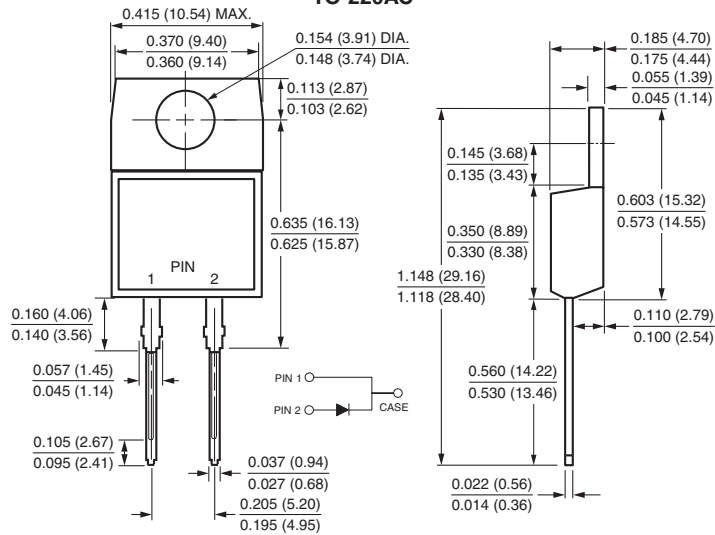

Fig. 6 - Reverse Switching Characteristics



PACKAGE OUTLINE DIMENSIONS in inches (millimeters)

TO-220AC



ITO-220AC

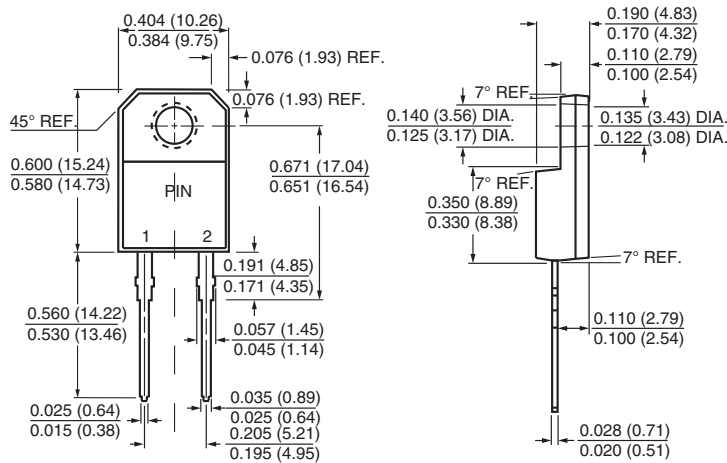

D²PAK (TO-263AB)

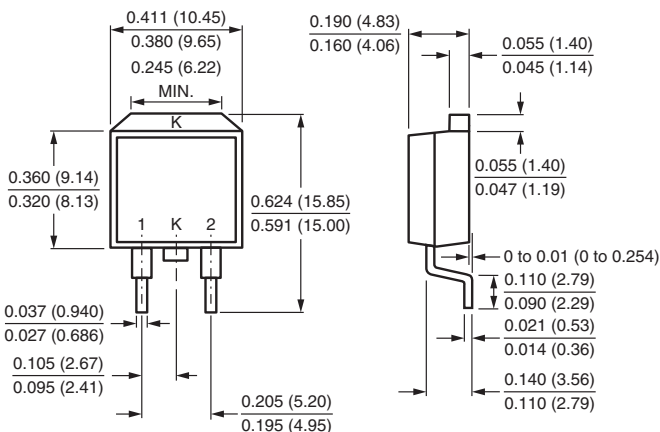

Mounting Pad Layout

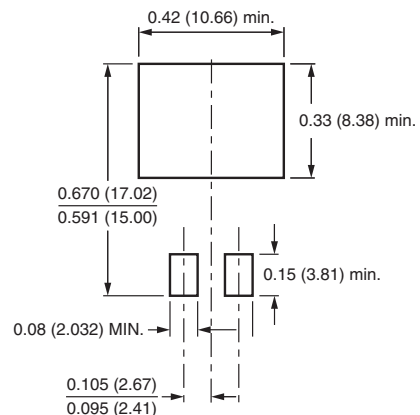



Disclaimer

ALL PRODUCT, PRODUCT SPECIFICATIONS AND DATA ARE SUBJECT TO CHANGE WITHOUT NOTICE TO IMPROVE RELIABILITY, FUNCTION OR DESIGN OR OTHERWISE.

Vishay Intertechnology, Inc., its affiliates, agents, and employees, and all persons acting on its or their behalf (collectively, "Vishay"), disclaim any and all liability for any errors, inaccuracies or incompleteness contained in any datasheet or in any other disclosure relating to any product.

Vishay makes no warranty, representation or guarantee regarding the suitability of the products for any particular purpose or the continuing production of any product. To the maximum extent permitted by applicable law, Vishay disclaims (i) any and all liability arising out of the application or use of any product, (ii) any and all liability, including without limitation special, consequential or incidental damages, and (iii) any and all implied warranties, including warranties of fitness for particular purpose, non-infringement and merchantability.

Statements regarding the suitability of products for certain types of applications are based on Vishay's knowledge of typical requirements that are often placed on Vishay products in generic applications. Such statements are not binding statements about the suitability of products for a particular application. It is the customer's responsibility to validate that a particular product with the properties described in the product specification is suitable for use in a particular application. Parameters provided in datasheets and / or specifications may vary in different applications and performance may vary over time. All operating parameters, including typical parameters, must be validated for each customer application by the customer's technical experts. Product specifications do not expand or otherwise modify Vishay's terms and conditions of purchase, including but not limited to the warranty expressed therein.

Except as expressly indicated in writing, Vishay products are not designed for use in medical, life-saving, or life-sustaining applications or for any other application in which the failure of the Vishay product could result in personal injury or death. Customers using or selling Vishay products not expressly indicated for use in such applications do so at their own risk. Please contact authorized Vishay personnel to obtain written terms and conditions regarding products designed for such applications.

No license, express or implied, by estoppel or otherwise, to any intellectual property rights is granted by this document or by any conduct of Vishay. Product names and markings noted herein may be trademarks of their respective owners.