

FYLF-1870PG1C

Features:

- High intensity
- General purpose leads
- RoHs compliant.

Descriptions:

- Dice material: InGaN
- Emitting Color: Pure Green
- Lens Type: Water clear

Radiation pattern.

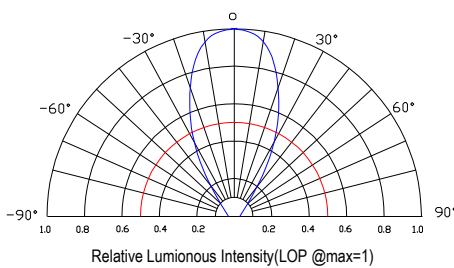

Package configuration

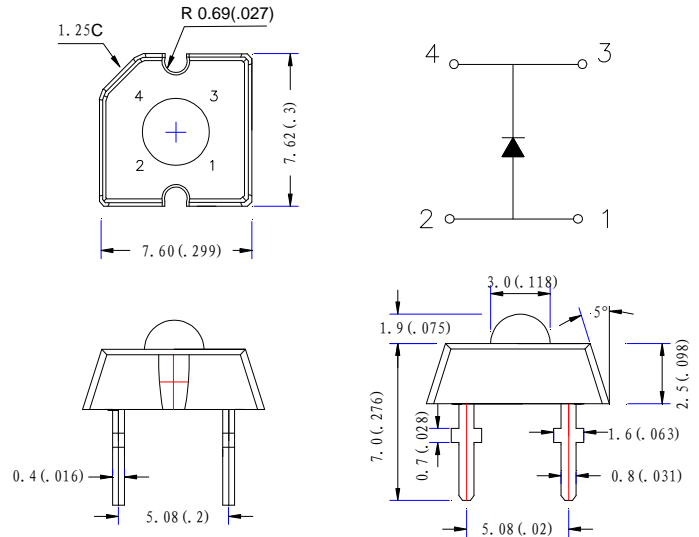

- ◆ All dimensions are millimeters (inches)
- ◆ Tolerance is $\pm 0.25\text{mm}(.010")$ unless otherwise noted.

Absolute maximum ratings($T_a=25^\circ\text{C}$)

Parameter	MAX.	Unit
Power Dissipation	70	mW
Peak Forward Current (1/10 Duty Cycle, 0.1ms Pulse Width)	100	mA
Continuous Forward Current	20	mA
Derating Linear From 50°C	0.4	mA/ $^\circ\text{C}$
Reverse Voltage	5	V
Electrostatic Discharge (ESD)	150	V
Operating Temperature Range	-30°C to $+80^\circ\text{C}$	
Storage Temperature Range	-40°C to $+100^\circ\text{C}$	
Lead Soldering Temperature[4mm(.157") From Body]	260 $^\circ\text{C}$ for 5 Seconds	

Electrical and optical characteristics($T_a=25^\circ\text{C}$)

Parameter	Symbol	Min.	Typ.	Max.	Unit	Test Condition
Luminous Intensity	I_v	-	3000	-	mcd	$I_F=20\text{mA}$
Viewing Angle	$2\theta_{1/2}$	50	60	70	Deg	
Peak Emission	λ_p	515	520	525	nm	
Dominant Wavelength	λ_d	517	522	527	nm	
Spectral Line Half-Width	$\Delta\lambda$	10	15	20	nm	
Forward Voltage	V_F	2.8	3.2	3.6	V	$V_R=5\text{V}$
Reverse Current	I_R			50	μA	

Typical Electrical Characteristics Curves (25 °c Ambient Temperature Unless Otherwise Noted)

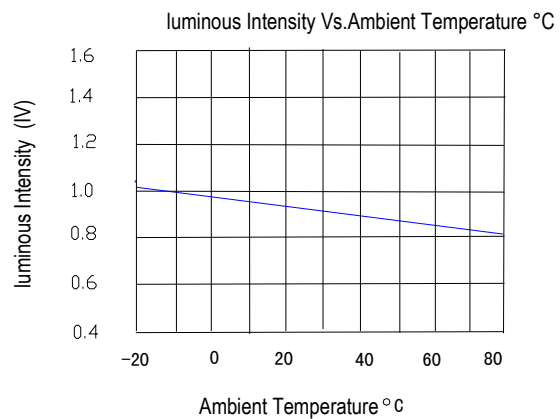
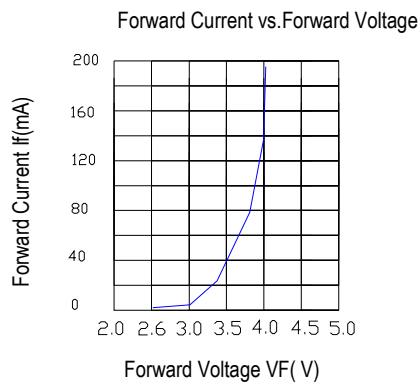
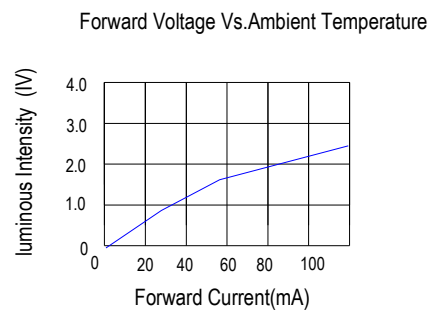
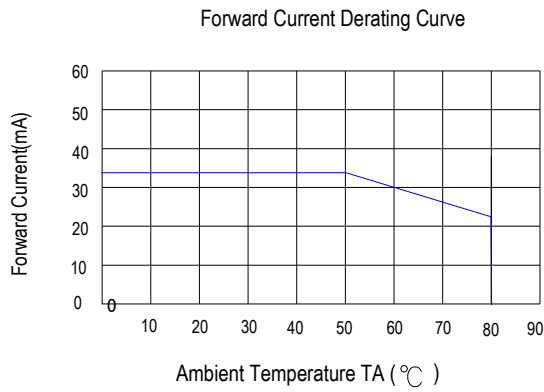
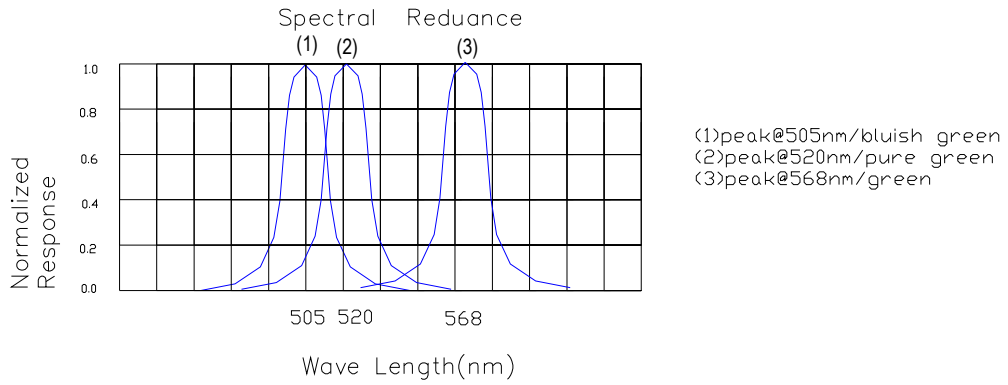

Flux LEDs PACKING.

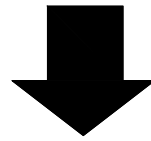
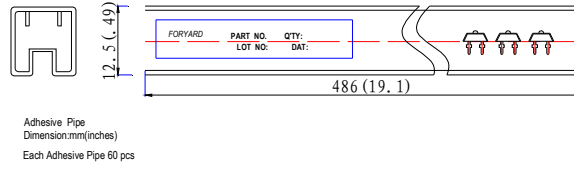
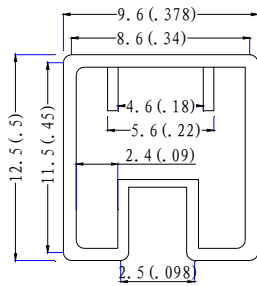

Box
Dimension (cm) : 53*15*16.5

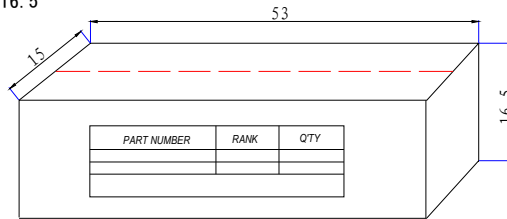

Each box/carotn 10,000pcs

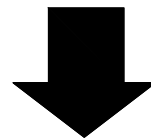

CARTON
Dimension(cm):56*32*34.4

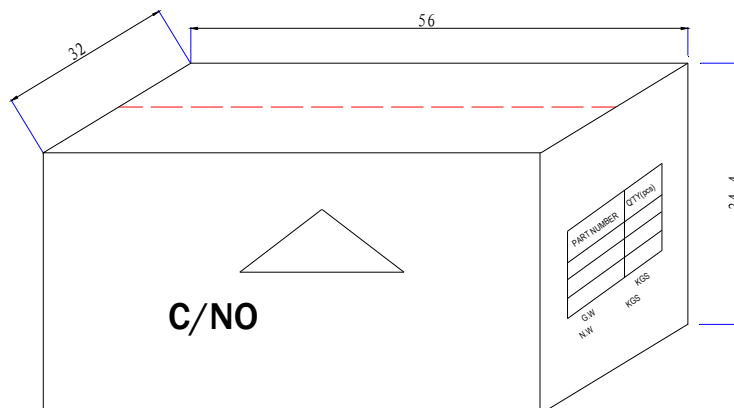

4 Boxes/Carton
Total :40,000pcs