

DATA SHEET

Part No.	AN15524A
Package Code No.	T0220-7A

Maintenance/Discontinued
(planned maintenance type, maintenance type, planned discontinued type, discontinued type)
Maintenance/Discontinued includes following four Product lifecycle stage

Contents

■ Overview	3
■ Features	3
■ Applications	3
■ Package	3
■ Application Circuit Example	4
■ Block Diagram	6
■ Pin Descriptions	6
■ Absolute Maximum Ratings	7
■ Operating Supply Voltage Range	7
■ Electrical Characteristics	8
• Reference Data for Designing	8
■ Description of Test Circuits Test Methods	9
■ Technical Data	12
• Package Power Dissipation	13
• Safe Operation Area	14
■ Precautions for Application	15

AN15524A

Silicon Monolithic Bipolar IC

■ Overview

AN15524A are ICs for CRT vertical deflection output. AN15524A can directly drive a deflection coil with saw wave output from a signal processing IC.

With its maximum output current of 1.6 A[p-p], AN15524A are suitable for the use of driving of 14 inch to 21 inch monitors.

■ Features

- Vertical output circuit
- Built-in pump up circuit
- Built-in thermal protection circuit
- Absolute maximum rating 70 V
- Maximum output current 1.6 A[p-p]

■ Applications

- CRT vertical output
- TV sets and displays

■ Package

- T0220-7pin Plastic Package with Fin

Maintenance/Discontinued

Maintenance/Discontinued includes following four Product lifecycle stage.
(planned maintenance type, maintenance type, planned discontinued type, discontinued type)

■ Application Circuit Example
 • AC Coupling

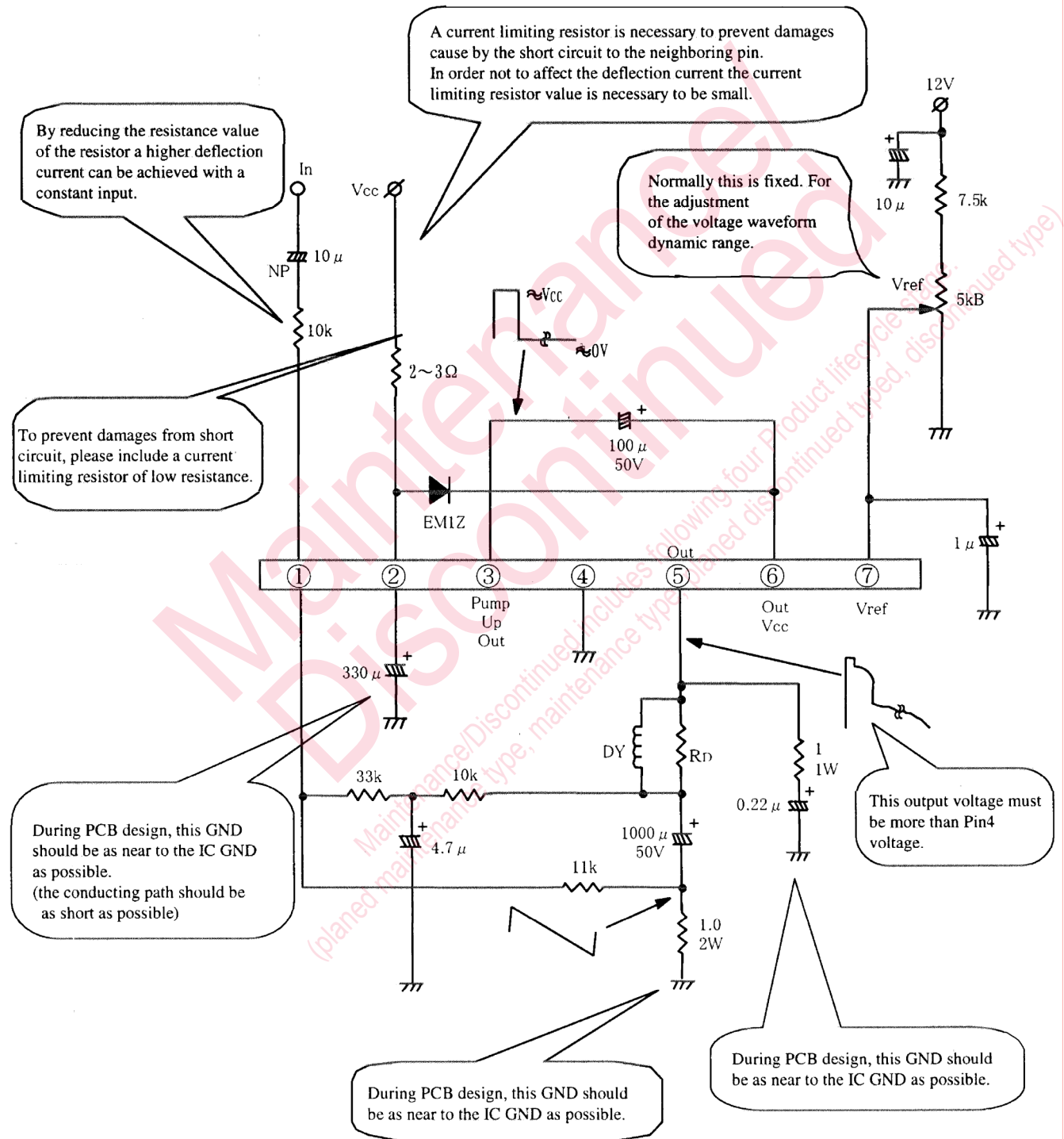

■ Application Circuit Example (continued)
 • DC Coupling

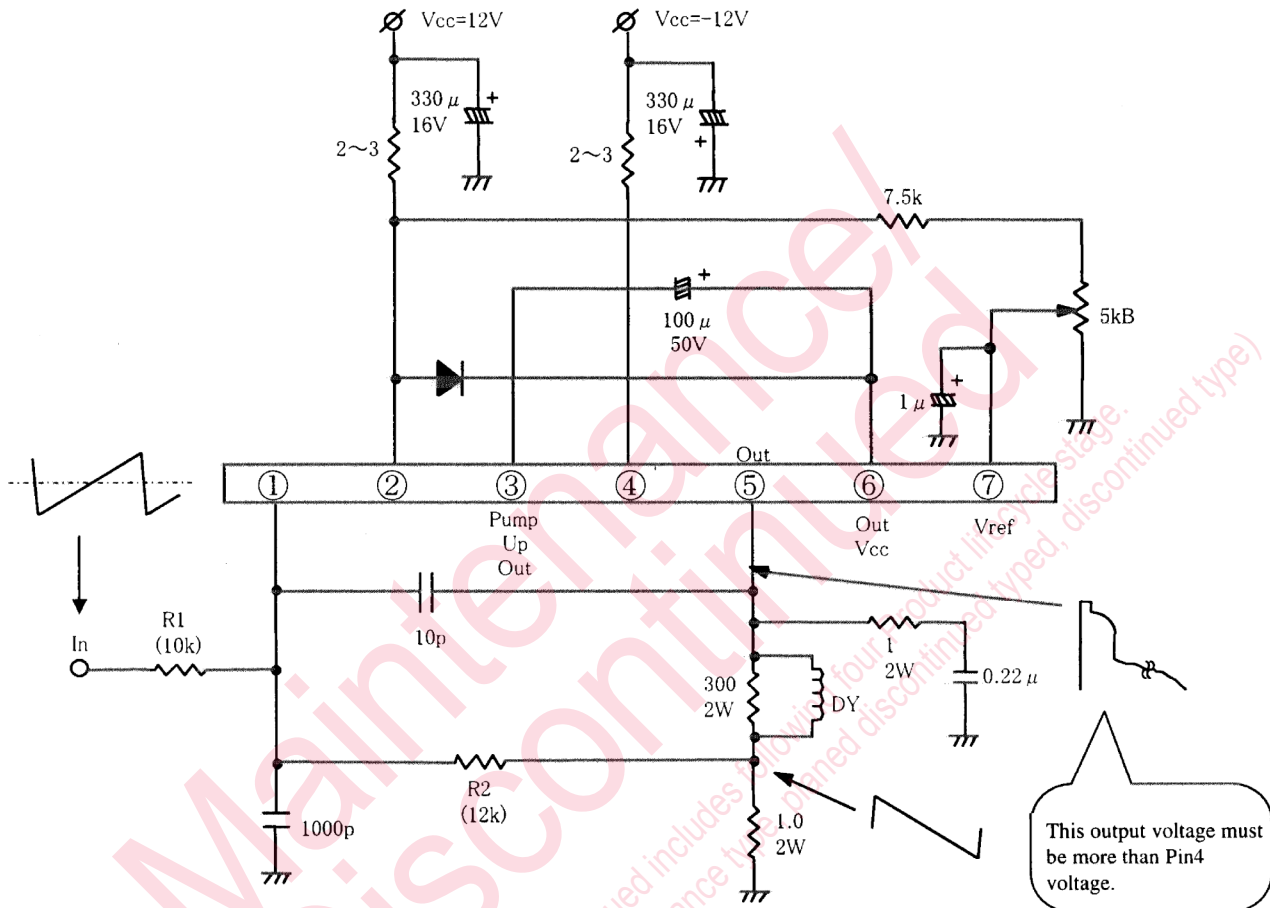

In order to get required gain, it is necessary to adjust the R1 and R2.

■ Block Diagram

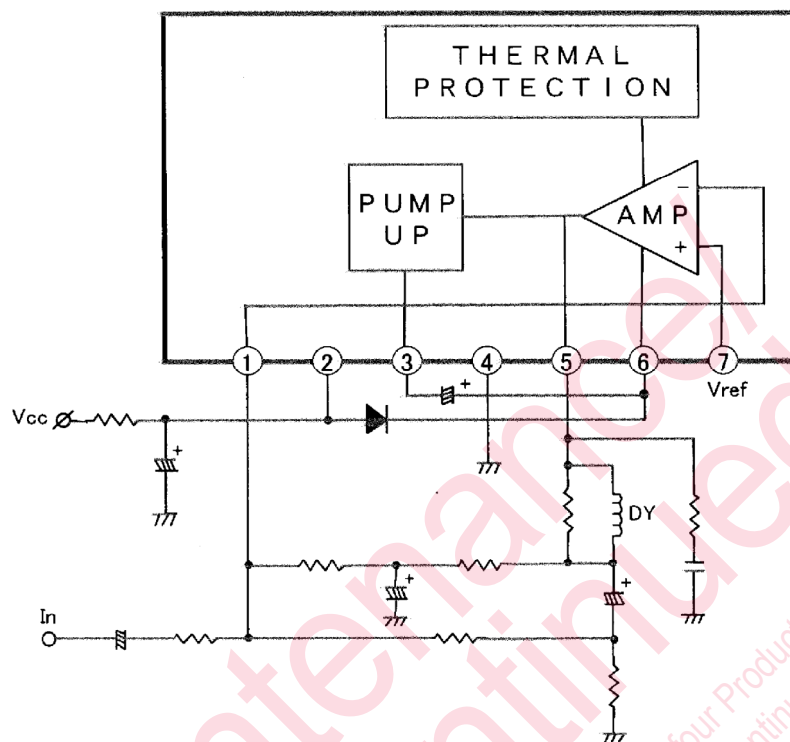

■ Pin Descriptions

Pin No.	Pin name
1	Inverting input
2	Power supply
3	Pump-up output
4	GND
5	Vertical output
6	Vertical output power supply
7	Non-inverting input

■ Absolute Maximum Ratings

Absolute Maximum Ratings						
No.	Parameter	Symbol	Rating		Unit	Note
1	Storage temperature	T_{stg}	- 55 to +150		°C	* 1
2	Operating ambient temperature	T_{opr}	- 20 to +70		°C	* 1
3	Operating ambient atmospheric pressure	P_{opr}	$1.013 \times 10^5 \pm 0.61 \times 10^5$		Pa	
4	Operating constant gravity	G_{opr}	9 810		m/S ²	
5	Operating shock	S_{opr}	4 900		m/S ²	
6	Supply voltage	V_{CC2}	35		V	
7	Supply current	I_{CC2}	360		mA	
8	Power dissipation	P_D	1.5		W	* 2
9	Circuit voltage	V_{5-4}, V_{6-4}	0	70	V	
10	Circuit voltage	V_{7-4}, V_{1-4}	0	V_{2-4}	V	
11	Circuit current	I_5, I_3	- 1.5	1.5	A[o-p]	

Note) *1: Expect for the operating ambient temperature and storage temperature, all ratings are for $T_a = 25^\circ\text{C}$.

Note) *2: The power dissipation shall be at $T_a = 70^\circ\text{C}$ in free air, without heat sink. (refer to sheet no. 13)

■ Operating Supply Voltage Range

Parameter	Symbol	Range	Unit	Note
Operating supply voltage range	V_{CC2}	12 to 30	V	
Deflection output current	I_{5p-p}	to 1.6	A [p-p]	

■ Electrical Characteristics at 25°C ± 2°C

B No.	Parameter	Symbol	Test circuits	Conditions	Limits			Unit	Note
					Min	Typ	Max		
1	Mid-point current	V_{MID}	2	$V_{CC} = 24\text{ V}$	11.5	12	12.5	V	
2	Output saturation voltage (Lower)	V_{5-4}	3	$V_{CC} = 24\text{ V}$ $I_5 = 0.8\text{ A}$	—	1.5	2.5	V	
3	Output saturation voltage (Upper)	V_{6-5}	4	$V_{CC} = 24\text{ V}$ $I_5 = -0.8\text{ A}$	—	2.4	3.4	V	
4	Pump-up charge saturation voltage	V_{3-4}	5	$V_{CC} = 24\text{ V}$ $I_3 = 20\text{ mA}$	—	0.8	1.2	V	
5	Pump-up discharge saturation voltage	V_{2-3}	6	$V_{CC} = 24\text{ V}$ $I_3 = -0.8\text{ A}$	—	1.8	2.8	V	

• Design reference data

b No.	Parameter	Symbol	Test circuits	Conditions	Reference			Unit	Note
					Min	Typ	Max		
1	Idling current	I_6	2	$V_{CC} = 24\text{ V}$	5	—	50	mA	
2	Thermal protection operating temperature	T_t	1	$V_{CC} = 24\text{ V}$ Temperature at output shutdown	150	—	—	°C	

Note) The above characteristics are theoretical values for designing and not guarantee by 100% inspection.

■ Description of Test Circuits Test Methods

Test Circuit – 1 (Thermal Production Operating Temperature)

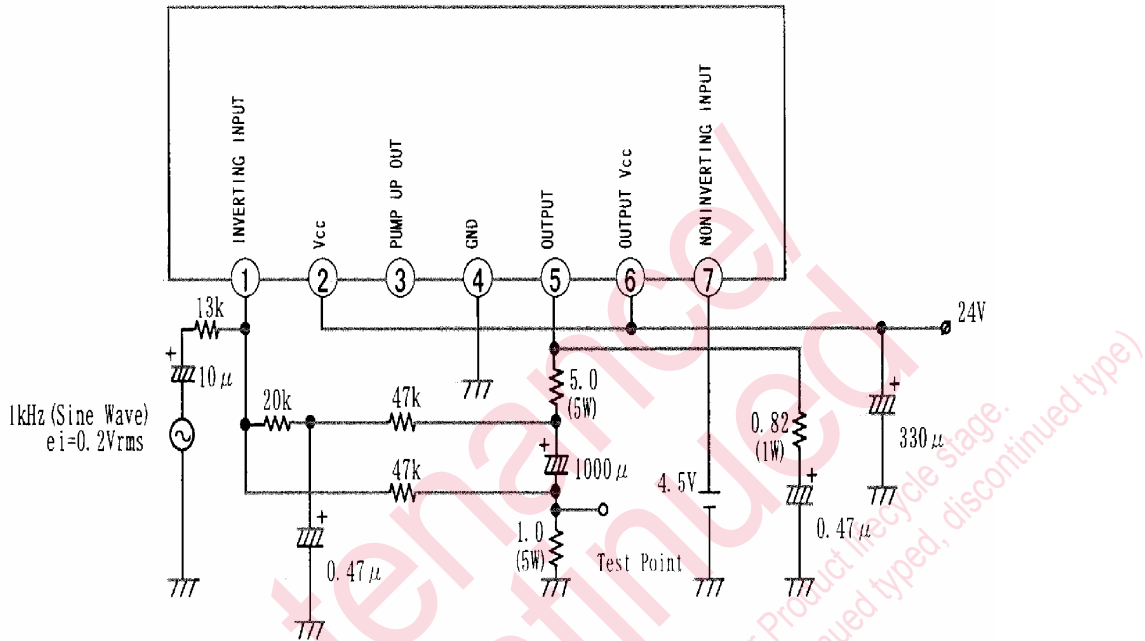

Test Circuit – 2 (Mid-point Voltage, Idling Current)

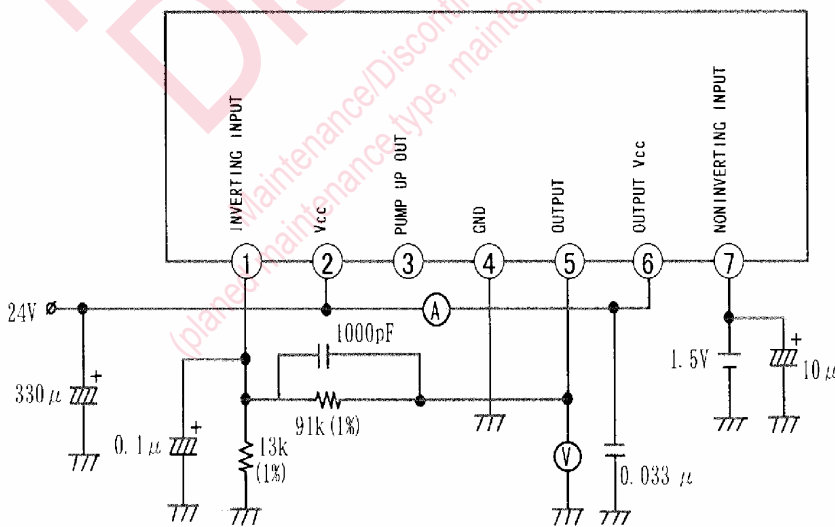

■ Description of Test Circuits Test Methods (continued)

Test Circuit – 3

(Output Saturation Voltage (Lower))

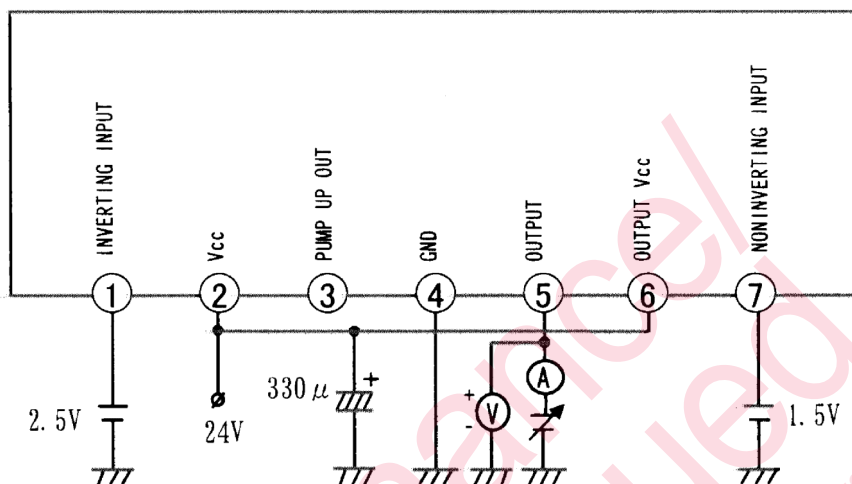

Monitor the voltage when the current is 0.8 A.

Test Circuit – 4

(Output Saturation Voltage (Upper))

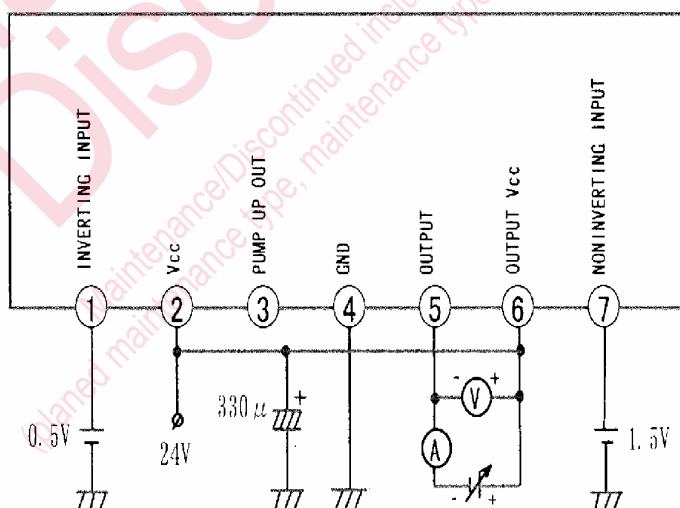

Monitor the voltage when the current is 0.8 A.

Note) : In case an external power supply is used, set the GND terminal open (floating).

■ Description of Test Circuits Test Methods (continued)

Test Circuit – 5

(Pump-up Charge Saturation Voltage)

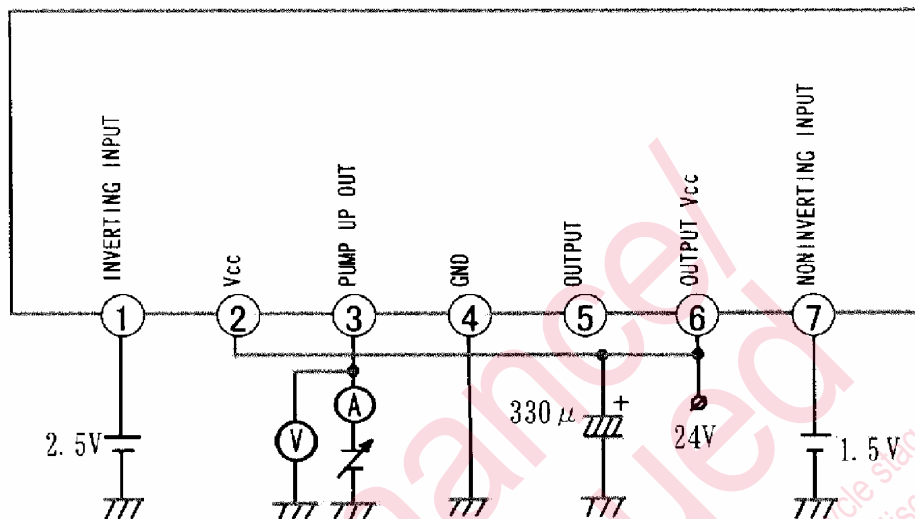

Monitor the voltage when the current is 20 mA.

Test Circuit – 6



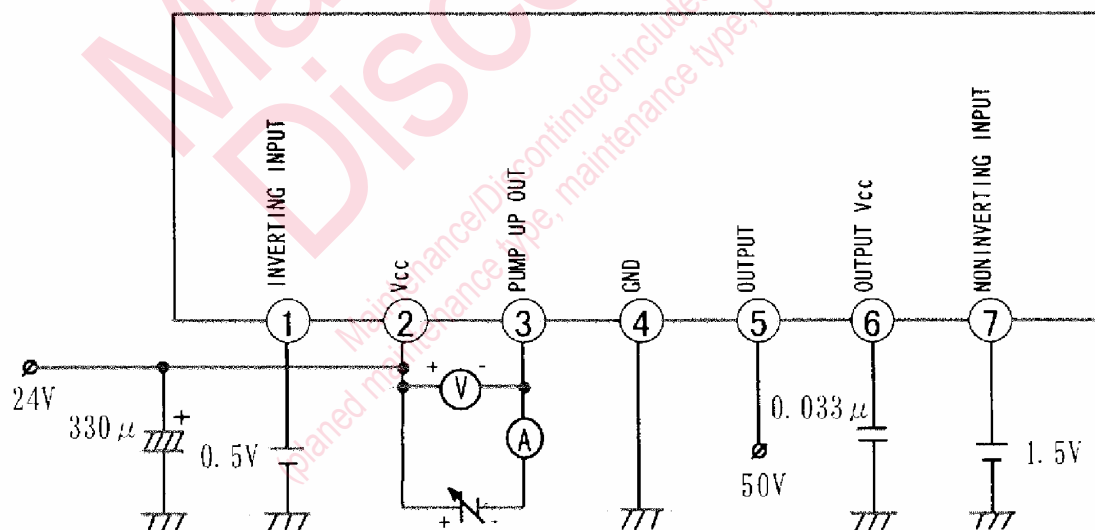

(Pump-up Discharge Saturation Voltage)

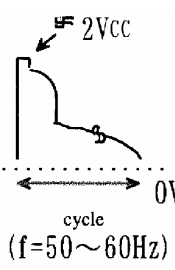
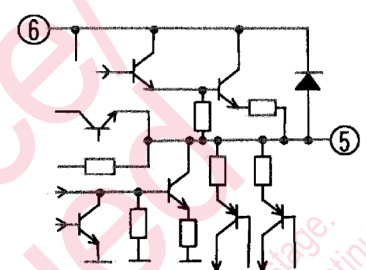

Monitor the voltage when the current is 0.8 A.

Note) : In case an external power supply is used, set the GND terminal open (floating).

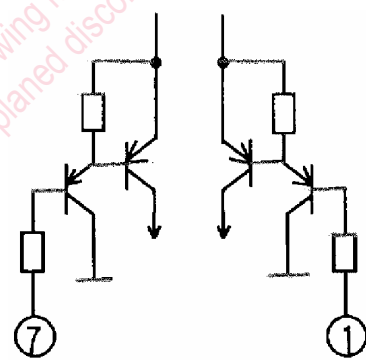
■ Technical Data

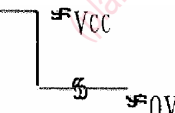
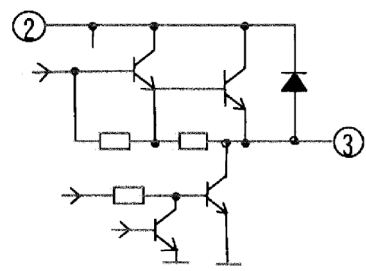
Pin No.	Pin name	Pin voltage (V)	Function	Equivalent circuit
4	GND	DC	—	—
5	Vertical output		A vertical deflection coil is connected and 1 A to 2 A of deflection current is provided through the pin. At this time, output voltage must be more than Pin 4 voltage.	
6	Vertical output power supply		About $V_{CC} \times 2$ for flyback period and $V_{CC} - V_D$ for the other period are supplied.	—
7	Non inverting input	DC External bias	About 2 V is supplied. Very high sensitivity may cause abnormal oscillation.	
1	Inverting input		Input signal and CR network for feedback are connected. Very high sensitivity.	
2	Power supply	DC	10 V to 29 V is supplied.	—
3	Pump-up output		A capacitor connected between this pin and pin 6 is charged and discharge during flyback pulse in order to supply about $V_{CC} \times 2$ to pin 6.	

■ Technical Data (continued)

● Package Power Dissipation

$$P_D - T_a$$

$$R_{th(j-c)} = 5^{\circ}\text{C/W}$$

$$R_{th(j-a)} = 65^{\circ}\text{C/W}$$

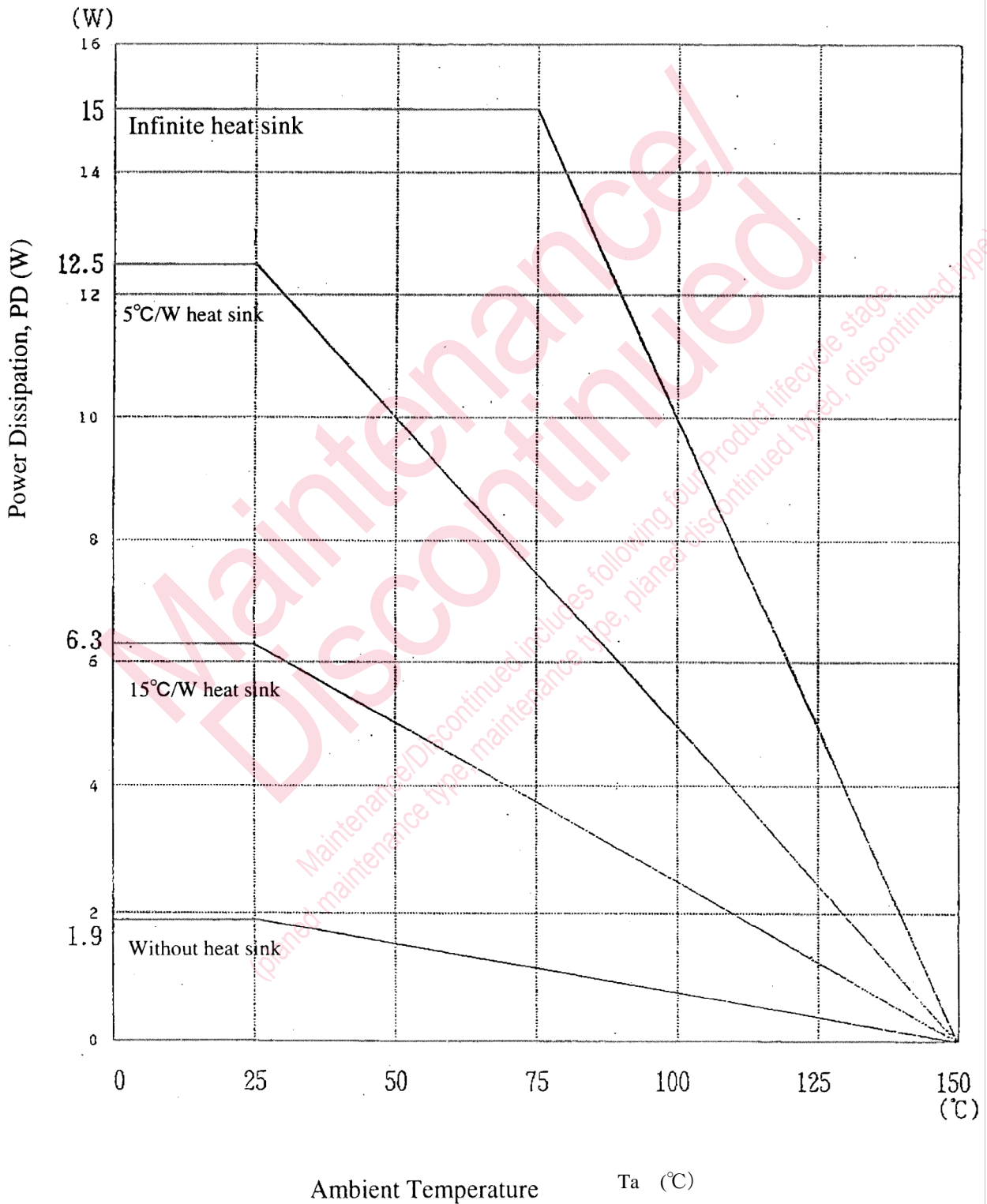

■ Technical Data (continued)

- Safe Operation Area

ASO DATA

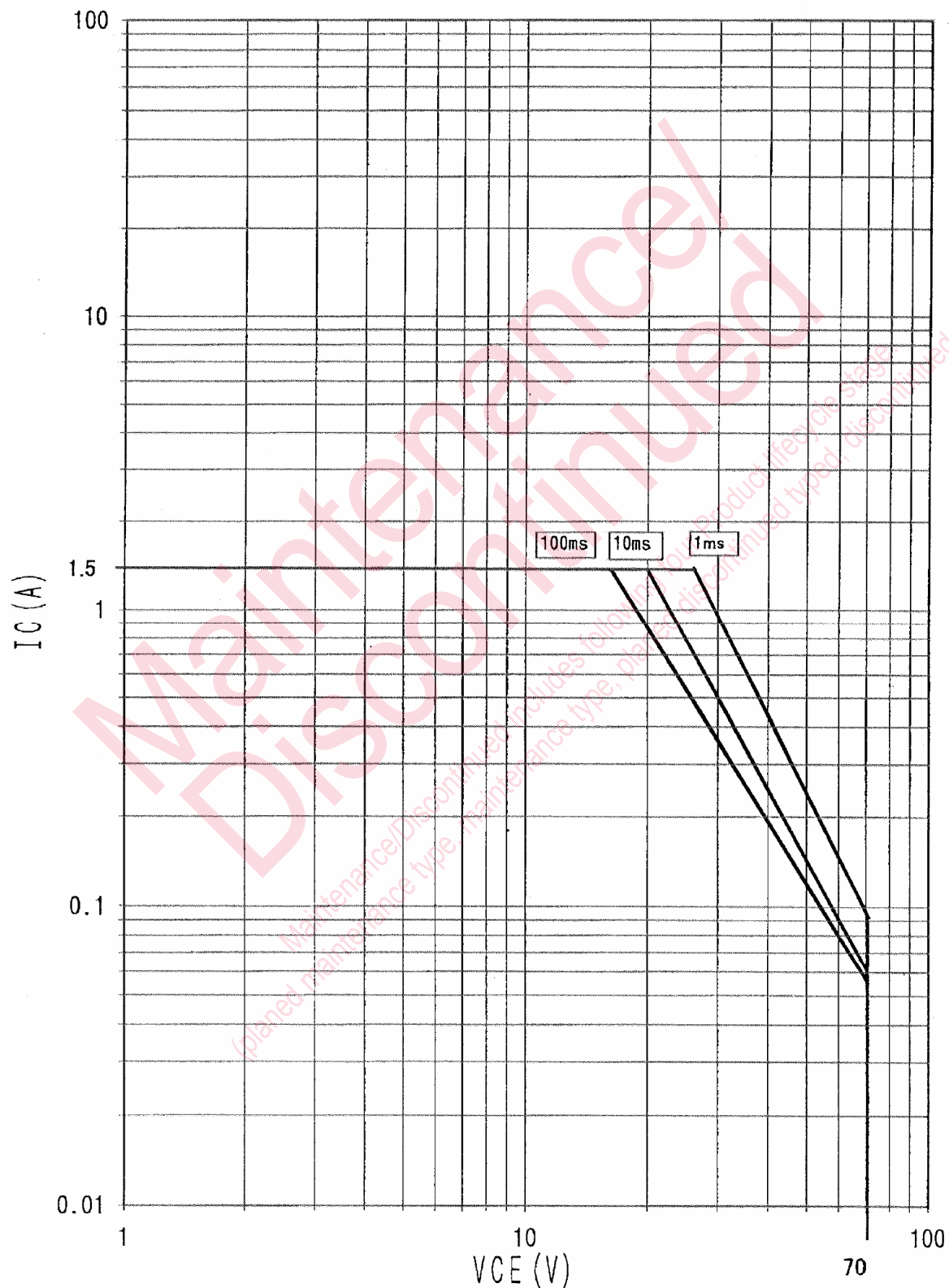

■ Precautions for Application

Test result of short between pins

Test condition : $V_{CC} = 30\text{ V}$

DC power supply (30 V , 5 A)

1							
2	○						
3	○	○					
4	○	×	○				
5	○	○	○	×			
6	○	○	○	×	○		
7	○	○	○	○	○	○	
Pin No.	1	2	3	4	5	6	7
	INVERTING INPUT	V_{CC}	PUMP UP OUT	GND	OUTPUT	OUTPUT V_{CC}	NON INVERTING INPUT

○: No destruction of IC for pins short for 3secs.

×: Destruction of IC for pins short for 1second.

After destruction, continuous supply of V_{CC} may cause IC package to crack.

To prevent this problem, insert resistance (2 Ω to 3 Ω) for over current limited in V_{CC} line.

■ Precautions for Application (continued)

Maximum Current at Pin 3

This is a regulation of output peak current during the flyback period.

Operating Conditions

$$V_{CC} = 30 \text{ V}$$

$$I_{5p-p} = 1.6 \text{ A [p-p]}$$

In case of using external component shown in application circuit (page 4),

I_3 is tolerated up to 7 A ($I_3 \leq 7 \text{ A}$) with 0.1 m sec single pulse on condition that V_{2-3} is less than 30 V ($V_{2-3} \leq 30 \text{ V}$).

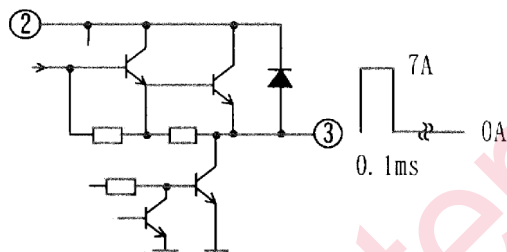

Maintenance/Discontinued

Maintenance/Discontinued includes following four Product lifecycle stage.
(planned maintenance type, maintenance type, planned discontinued type, discontinued type)

Request for your special attention and precautions in using the technical information and semiconductors described in this book

- (1) If any of the products or technical information described in this book is to be exported or provided to non-residents, the laws and regulations of the exporting country, especially, those with regard to security export control, must be observed.
- (2) The technical information described in this book is intended only to show the main characteristics and application circuit examples of the products, and no license is granted under any intellectual property right or other right owned by our company or any other company. Therefore, no responsibility is assumed by our company as to the infringement upon any such right owned by any other company which may arise as a result of the use of technical information described in this book.
- (3) The products described in this book are intended to be used for standard applications or general electronic equipment (such as office equipment, communications equipment, measuring instruments and household appliances).
Consult our sales staff in advance for information on the following applications:
 - Special applications (such as for airplanes, aerospace, automobiles, traffic control equipment, combustion equipment, life support systems and safety devices) in which exceptional quality and reliability are required, or if the failure or malfunction of the products may directly jeopardize life or harm the human body.
 - Any applications other than the standard applications intended.
- (4) The products and product specifications described in this book are subject to change without notice for modification and/or improvement. At the final stage of your design, purchasing, or use of the products, therefore, ask for the most up-to-date Product Standards in advance to make sure that the latest specifications satisfy your requirements.
- (5) When designing your equipment, comply with the range of absolute maximum rating and the guaranteed operating conditions (operating power supply voltage and operating environment etc.). Especially, please be careful not to exceed the range of absolute maximum rating on the transient state, such as power-on, power-off and mode-switching. Otherwise, we will not be liable for any defect which may arise later in your equipment.
 - Even when the products are used within the guaranteed values, take into the consideration of incidence of break down and failure mode, possible to occur to semiconductor products. Measures on the systems such as redundant design, arresting the spread of fire or preventing glitch are recommended in order to prevent physical injury, fire, social damages, for example, by using the products.
- (6) Comply with the instructions for use in order to prevent breakdown and characteristics change due to external factors (ESD, EOS, thermal stress and mechanical stress) at the time of handling, mounting or at customer's process. When using products for which damp-proof packing is required, satisfy the conditions, such as shelf life and the elapsed time since first opening the packages.
- (7) This book may be not reprinted or reproduced whether wholly or partially, without the prior written permission of Matsushita Electric Industrial Co., Ltd.