

尺寸 Size: 172mm × 150mm × 51mm
 风量 Airflow: 105–235CFM
 重量 Weight: 820g
 噪音 Noise: 30–50dB(A)
 风叶 Impeller Material: PBT UL94–V0 Reinforced Plastic
 外框 Frame: Aluminum Alloy
 端子 Terminals: 0.5mm
 引线 Lead Wire: AWG#22 UL 1569(Optional)
 马达 Motor: Shaded Pole Induction Motor
 温度范围 Operating Temperature: –10°C~+65°C

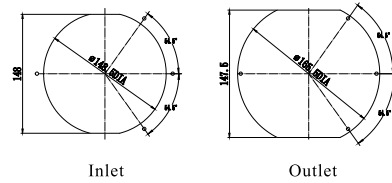

产品型号 Model	轴承型式 Bearing System	电压 Voltage VAC	频率 Freq. Hz	电流 Current A	功率 Power W	转速 Speed RPM	噪音 Noise dB(A)	风量 Air Flow CFM	相数 Phase	电容 Capacitor μF/VAC
G17050HA,S	Sleeve	100/125	50/60	0.50/0.45	37/36	2700/3100	45/50	190/235	1	/
G17050HA,S		200/240	50/60	0.22/0.21	34/33	2700/3100	45/50	190/235	1	/
G17050HA,S		380/420	50	0.11	34	2700	45	190	1	/
G17050HA,B	Ball	100/125	50/60	0.50/0.45	37/36	2700/3100	45/50	190/235	1	/
G17050HA,B		200/240	50/60	0.22/0.21	34/33	2700/3100	45/50	190/235	1	/
G17050HA,B		380/420	50	0.11	34	2700	45	190	1	/
G17050MA,S	Sleeve	100/125	50/60	0.41/0.39	32/30	2400/2300	41/40	170/160	1	/
G17050MA,S		200/240	50/60	0.19/0.18	30/28	2400/2300	41/40	170/160	1	/
G17050MA,S		380/420	50	0.09	30	2400	41	170	1	/
G17050MA,B	Ball	100/125	50/60	0.41/0.39	32/30	2400/2300	41/40	170/160	1	/
G17050MA,B		200/240	50/60	0.19/0.18	30/28	2400/2300	41/40	170/160	1	/
G17050MA,B		380/420	50	0.09	30	2400	41	170	1	/
G17050LA,S	Sleeve	100/125	50/60	0.35/0.35	26/25	1900/1500	32/30	125/105	1	/
G17050LA,S		200/240	50/60	0.16/0.16	26/25	1900/1500	32/30	125/105	1	/
G17050LA,S		380/420	50	0.07	26	1900	32	125	1	/
G17050LA,B	Ball	100/125	50/60	0.35/0.35	26/25	1900/1500	32/30	125/105	1	/
G17050LA,B		200/240	50/60	0.16/0.16	26/25	1900/1500	32/30	125/105	1	/
G17050LA,B		380/420	50	0.07	26	1900	32	125	1	/

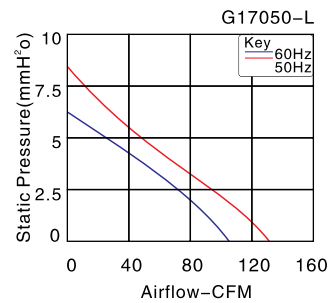
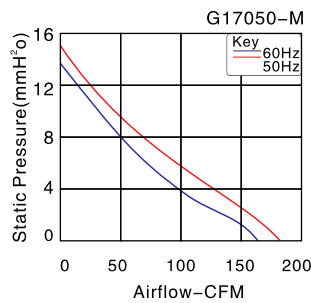
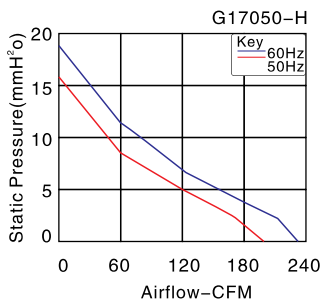

Fan Accessories

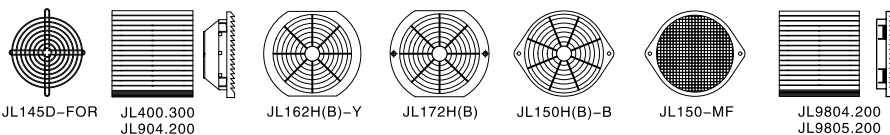

本册图仅供参考，具体以规格书为准。
 This sample book is for reference only. Please refer to the specification for details.
 如特殊电压也可提供，本公司保留技术改动的权利。
 Special voltage may be provided if necessary according to enquiry. Along with technical modification right reserved.

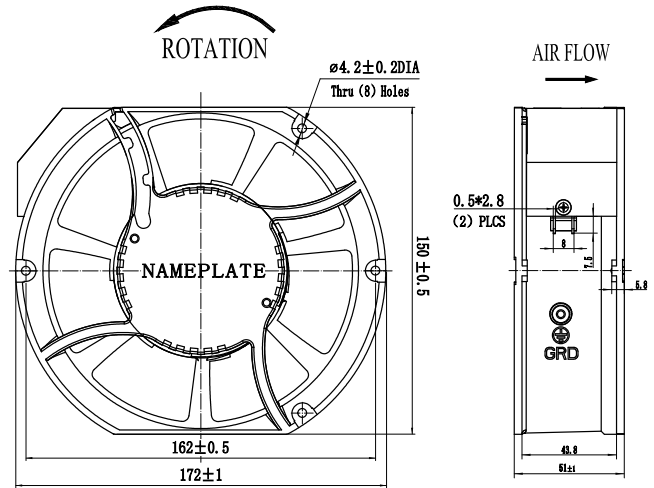

尺寸 Size: 172mm × 150mm × 51mm
 风量 Airflow: 115–245CFM
 重量 Weight: 850g
 噪音 Noise: 30–52dB(A)
 风叶 Impeller Material: PBT UL94–V0 Reinforced Plastic
 外框 Frame: Aluminum Alloy
 端子 Terminals: 0.5mm
 引线 Lead Wire: AWG#22 UL 1569(Optional)
 马达 Motor: Shaded Pole Induction Motor
 温度范围 Operating Temperature: $-10^{\circ}\text{C} \sim +65^{\circ}\text{C}$

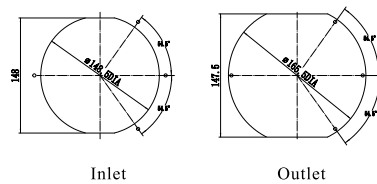

产品型号 Model	轴承型式 Bearing System	电压 Voltage VAC	频率 Freq. Hz	电流 Current A	功率 Power W	转速 Speed RPM	噪音 Noise dB(A)	风量 Air Flow CFM	相数 Phase	电容 Capacitor $\mu\text{F/VAC}$
G17050HA,S-7P	Sleeve	100/125	50/60	0.50/0.45	37/36	2600/3000	46/52	200/245	1	/
G17050HA,S-7P		200/240	50/60	0.22/0.21	34/33	2600/3000	46/52	200/245	1	/
G17050HA,S-7P		380/420	50	0.11	34	2600	46	200	1	/
G17050HA,B-7P	Ball	100/125	50/60	0.50/0.45	37/36	2600/3000	46/52	200/245	1	/
G17050HA,B-7P		200/240	50/60	0.22/0.21	34/33	2600/3000	46/52	200/245	1	/
G17050HA,B-7P		380/420	50	0.11	34	2600	46	200	1	/
G17050MA,S-7P	Sleeve	100/125	50/60	0.41/0.39	32/30	2400/2300	43/42	178/166	1	/
G17050MA,S-7P		200/240	50/60	0.19/0.18	30/28	2400/2300	43/42	178/166	1	/
G17050MA,S-7P		380/420	50	0.09	30	2400	43	178	1	/
G17050MA,B-7P	Ball	100/125	50/60	0.41/0.39	32/30	2400/2300	43/42	178/166	1	/
G17050MA,B-7P		200/240	50/60	0.19/0.18	30/28	2400/2300	43/42	178/166	1	/
G17050MA,B-7P		380/420	50	0.09	30	2400	43	178	1	/
G17050LA,S-7P	Sleeve	100/125	50/60	0.35/0.35	26/25	1900/1500	35/30	130/115	1	/
G17050LA,S-7P		200/240	50/60	0.16/0.16	26/25	1900/1500	35/30	130/115	1	/
G17050LA,S-7P		380/420	50	0.07	26	1900	35	130	1	/
G17050LA,B-7P	Ball	100/125	50/60	0.35/0.35	26/25	1900/1500	35/30	130/115	1	/
G17050LA,B-7P		200/240	50/60	0.16/0.16	26/25	1900/1500	35/30	130/115	1	/
G17050LA,B-7P		380/420	50	0.07	26	1900	35	130	1	/

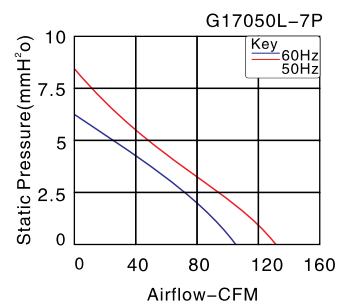
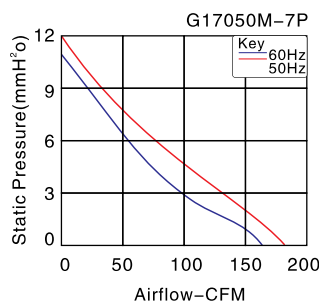
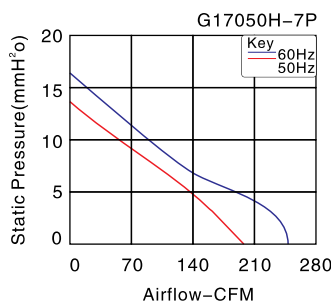

Fan Accessories

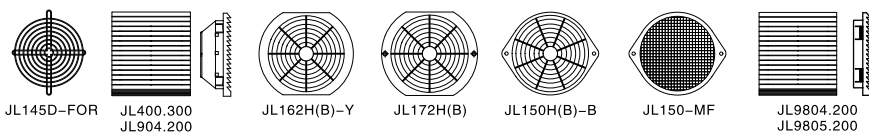

AC Axial Fan
AC 轴流风机

AC All-Metal Axial Fan
AC 全金属轴流风扇

DC Axial Fan
DC 轴流风机

DC Centrifugal Fan
DC 离心风机

EC Axial Fan
EC 轴流风机

EC Centrifugal Fan
EC 离心风机

AC Centrifugal Fan
AC 离心风机

Fan Accessories
风机配件

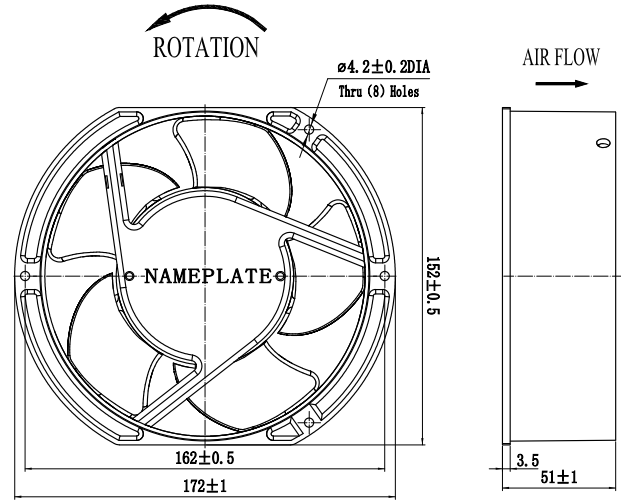

尺寸 Size: $\varnothing 172\text{mm} \times 51\text{mm}$
 风量 Airflow: 105-235CFM
 重量 Weight: 840g
 噪音 Noise: 30-50dB(A)
 风叶 Impeller Material: PBT UL94-V0 Reinforced Plastic
 外框 Frame: Aluminum Alloy
 端子 Terminals: 0.5mm
 引线 Lead Wire: AWG#22 UL 1569(Optional)
 马达 Motor: Shaded Pole Induction Motor
 温度范围 Operating Temperature: $-10^{\circ}\text{C} \sim +65^{\circ}\text{C}$

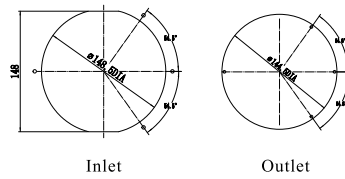

产品型号 Model	轴承型式 Bearing System	电压 Voltage VAC	频率 Freq. Hz	电流 Current A	功率 Power W	转速 Speed RPM	噪音 Noise dB(A)	风量 Air Flow CFM	相数 Phase	电容 Capacitor $\mu\text{F/VAC}$
G17050HA,S-D	Sleeve	100/125	50/60	0.50/0.45	37/36	2700/3100	45/50	190/235	1	/
G17050HA,S-D		200/240	50/60	0.22/0.21	34/33	2700/3100	45/50	190/235	1	/
G17050HA,S-D		380/420	50	0.11	34	2700	45	190	1	/
G17050HA,B-D	Ball	100/125	50/60	0.50/0.45	37/36	2700/3100	45/50	190/235	1	/
G17050HA,B-D		200/240	50/60	0.22/0.21	34/33	2700/3100	45/50	190/235	1	/
G17050HA,B-D		380/420	50	0.11	34	2700	45	190	1	/
G17050MA,S-D	Sleeve	100/125	50/60	0.41/0.39	32/30	2400/2300	41/40	170/160	1	/
G17050MA,S-D		200/240	50/60	0.19/0.18	30/28	2400/2300	41/40	170/160	1	/
G17050MA,S-D		380/420	50	0.09	30	2400	41	170	1	/
G17050MA,B-D	Ball	100/125	50/60	0.41/0.39	32/30	2400/2300	41/40	170/160	1	/
G17050MA,B-D		200/240	50/60	0.19/0.18	30/28	2400/2300	41/40	170/160	1	/
G17050MA,B-D		380/420	50	0.09	30	2400	41	170	1	/
G17050LA,S-D	Sleeve	100/125	50/60	0.35/0.35	26/25	1900/1500	32/30	125/105	1	/
G17050LA,S-D		200/240	50/60	0.16/0.16	26/25	1900/1500	32/30	125/105	1	/
G17050LA,S-D		380/420	50	0.07	26	1900	32	125	1	/
G17050LA,B-D	Ball	100/125	50/60	0.35/0.35	26/25	1900/1500	32/30	125/105	1	/
G17050LA,B-D		200/240	50/60	0.16/0.16	26/25	1900/1500	32/30	125/105	1	/
G17050LA,B-D		380/420	50	0.07	26	1900	32	125	1	/

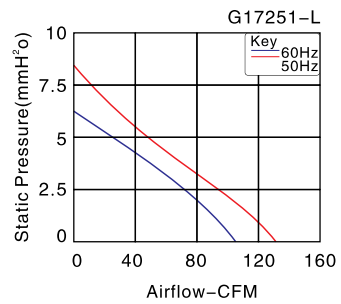
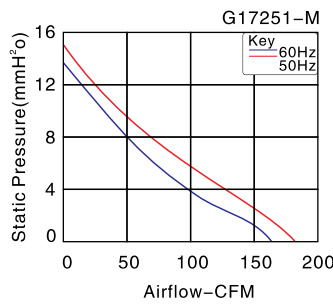
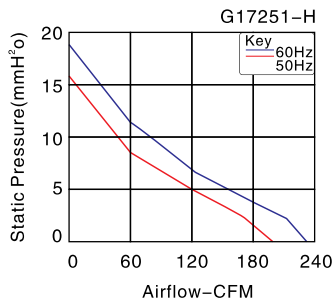

Fan Accessories

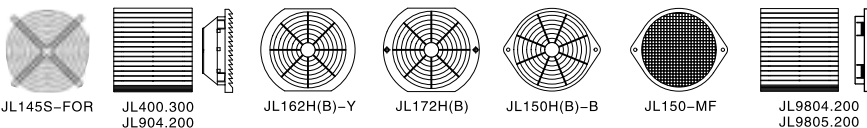

本样册仅供参考，具体以规格书为准。
 This sample book is for reference only, please refer to the specification for details.
 如属特殊电压也可相照洽询提供，本公司保留技术改动的权利。
 Special voltage may be provided if necessary, according to the inquiry. Julong all technical modification rights reserved.

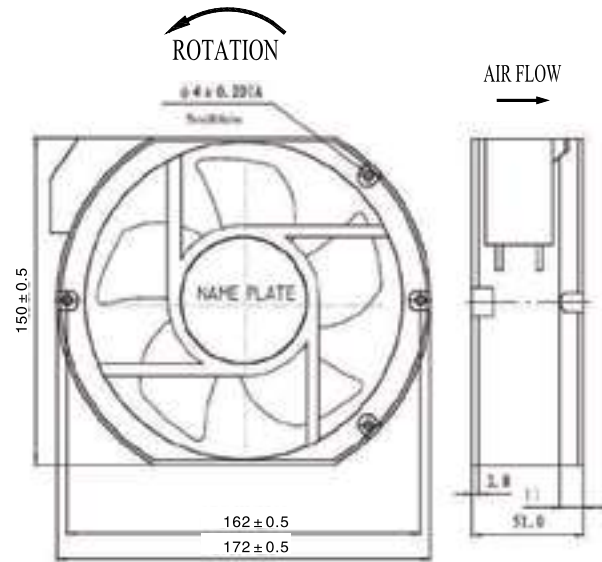

尺寸 Size: 172mm × 150mm × 51mm
 风量 Airflow: 215–225CFM
 重量 Weight: 880g
 噪音 Noise: 51–58dB(A)
 风叶 Impeller Material: PBT UL94–V0 Reinforced Plastic
 外框 Frame: Aluminum Alloy
 端子 Terminals: 0.5mm
 引线 Lead Wire: AWG#22 UL 1569(Optional)
 马达 Motor: Capacitor–Run Induction Motor
 温度范围 Operating Temperature: –10°C~+65°C

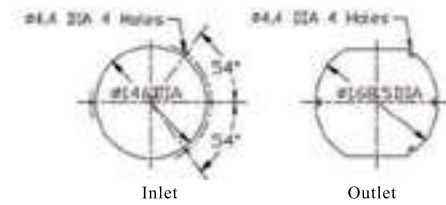

产品型号 Model	轴承型式 Bearing System	电压 Voltage VAC	频率 Freq. Hz	电流 Current A	功率 Power W	转速 Speed RPM	噪音 Noise dB(A)	风量 Air Flow CFM	相数 Phase	电容 Capacitor μ F/VAC
G17050HA,B–C	Ball	100/125	50/60	0.38/0.32	35/34	2850/3350	51/58	215/225	1	3.3/250
G17050HA ₂ B–C	Ball	200/240	50/60	0.11/0.11	25/27	2850/3350	51/58	215/225	1	0.75/500

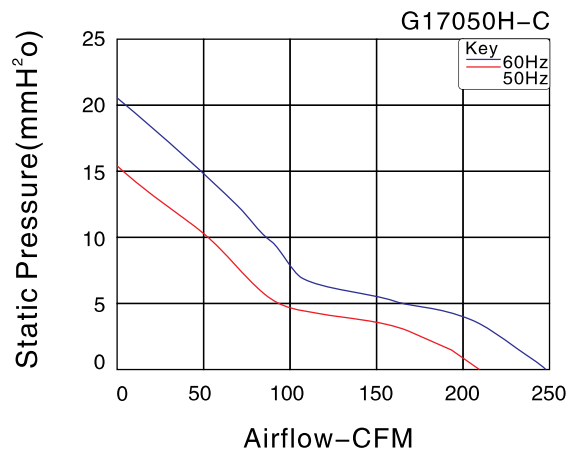

Fan Accessories

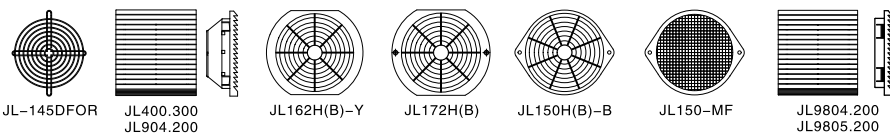

AC Axial Fan
AC轴流风机

AC All-Metal Axial Fan
AC全金属轴流风扇

DC Axial Fan
DC轴流风机

DC Centrifugal Fan
DC离心风机

EC Axial Fan
EC轴流风机

EC Centrifugal Fan
EC离心风机

AC Centrifugal Fan
AC离心风机

Fan Accessories
风机配件