

CD4093B-Q1 CMOS QUAD 2-INPUT NAND SCHMITT TRIGGER

SCLS608A – MARCH 2005 – REVISED APRIL 2008

- Qualified for Automotive Applications
- Schmitt-Trigger Action on Each Input With No External Components
- Hysteresis Voltage Typically 0.9 V at $V_{DD} = 5\text{ V}$ and 2.3 V at $V_{DD} = 10\text{ V}$
- Noise Immunity Greater Than 50%
- No Limit on Input Rise and Fall Times
- Standardized, Symmetrical Output Characteristics
- 100% Tested for Quiescent Current at 20 V
- Maximum Input Current of $1\mu\text{A}$ at 18 V Over Full Package Temperature Range, 100 nA at 18 V and 25°C
- 5-V, 10-V, and 15-V Parametric Ratings
- ESD Protection Level Per AEC-Q100 Classification
 - 2000-V (H2) Human-Body Model
 - 200-V (M3) Machine-Model
 - 1000-V (C5) Charge-Device Model
- Applications
 - Wave and Pulse Shapers
 - High-Noise-Environment Systems
 - Monostable Multivibrators
 - Astable Multivibrators
 - NAND Logic

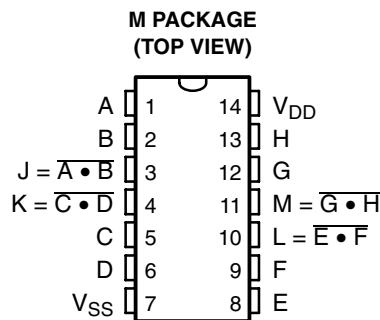

description/ordering information

The CD4093B consists of four Schmitt-trigger circuits. Each circuit functions as a two-input NAND gate, with Schmitt-trigger action on both inputs. The gate switches at different points for positive- and negative-going signals. The difference between the positive voltage (V_P) and the negative voltage (V_N) is defined as hysteresis voltage (V_H) (see Figure 2).

The CD4093B is available in 14-lead small-outline plastic package (M96) and 14-lead thin shrink small-outline packages (PWR suffixes).

ORDERING INFORMATION[†]

T_A	PACKAGE [‡]		ORDERABLE PART NUMBER	TOP-SIDE MARKING
-40°C to 125°C	SOIC (M)	Reel of 2000	CD4093BQM96Q1	CD4093BQ

[†] For the most current package and ordering information, see the Package Option Addendum at the end of this document, or see the TI web site at <http://www.ti.com>.

[‡] Package drawings, thermal data, and symbolization are available at <http://www.ti.com/packaging>.



Please be aware that an important notice concerning availability, standard warranty, and use in critical applications of Texas Instruments semiconductor products and disclaimers thereto appears at the end of this data sheet.

PRODUCTION DATA information is current as of publication date. Products conform to specifications per the terms of Texas Instruments standard warranty. Production processing does not necessarily include testing of all parameters.

 **TEXAS
INSTRUMENTS**

POST OFFICE BOX 655303 • DALLAS, TEXAS 75265

Copyright © 2008, Texas Instruments Incorporated

CD4093B-Q1 CMOS QUAD 2-INPUT NAND SCHMITT TRIGGER

SCLS608A – MARCH 2005 – REVISED APRIL 2008

functional block diagram

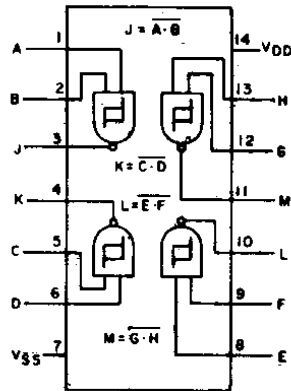

logic diagram

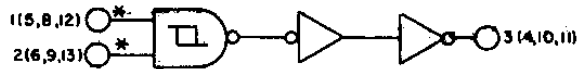

* ALL INPUTS PROTECTED BY CMOS PROTECTION NETWORK

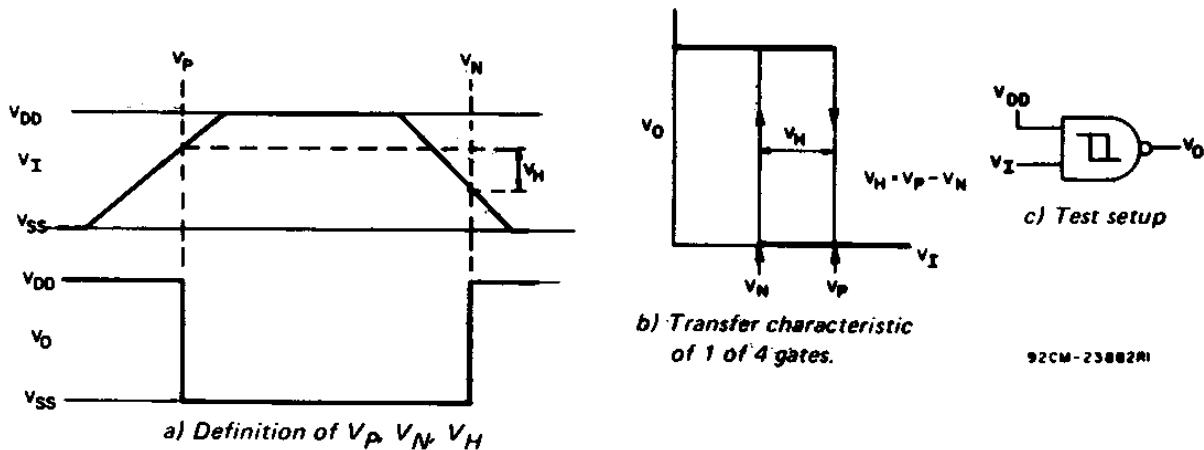
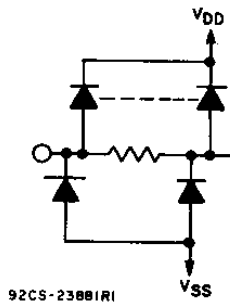

Figure 1. Hysteresis Definition, Characteristic, and Test Setup

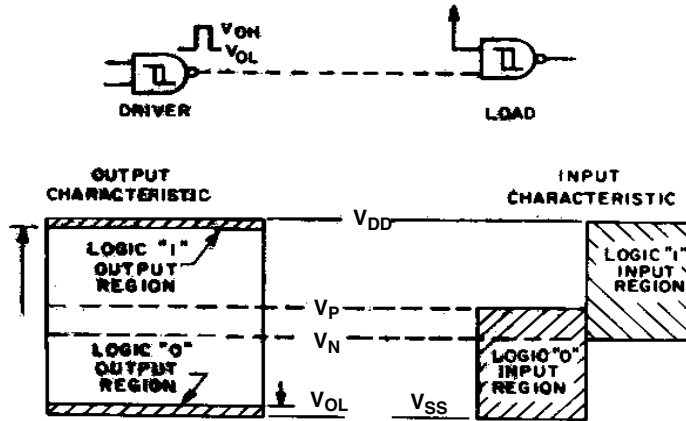

Figure 2. Input and Output Characteristics

TYPICAL CHARACTERISTICS

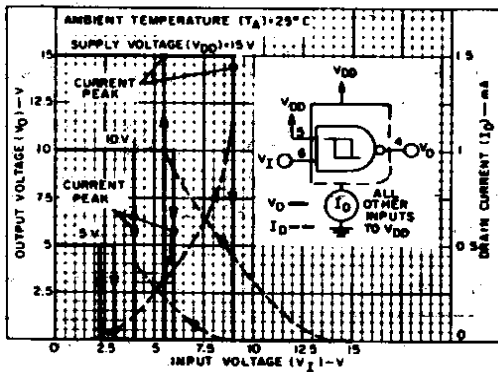

Figure 3. Typical Current and Voltage Transfer Characteristics

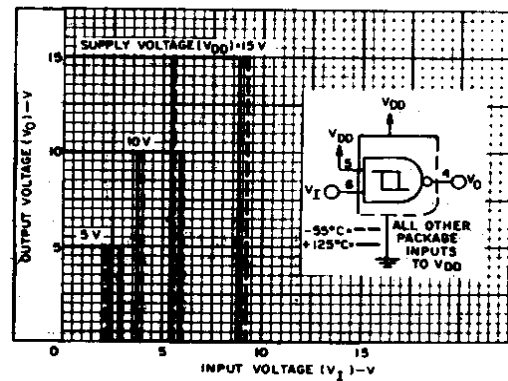

Figure 4. Typical Voltage Transfer Characteristics as a Function of Temperature

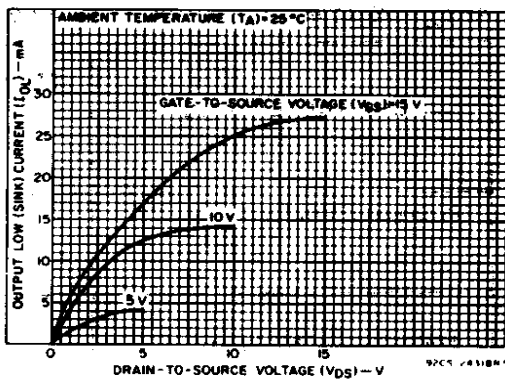

Figure 5. Typical Output Low (Sink) Current Characteristics

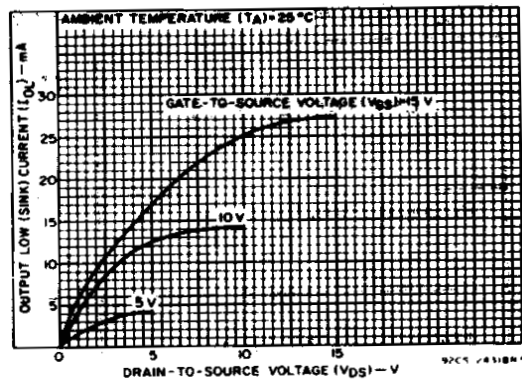

Figure 6. Minimum Output Low (Sink) Current Characteristics

CD4093B-Q1 CMOS QUAD 2-INPUT NAND SCHMITT TRIGGER

SCLS608A – MARCH 2005 – REVISED APRIL 2008

TYPICAL CHARACTERISTICS

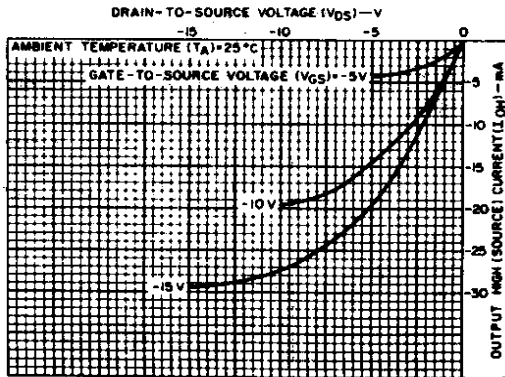

Figure 7. Typical Output High (Source) Current Characteristics

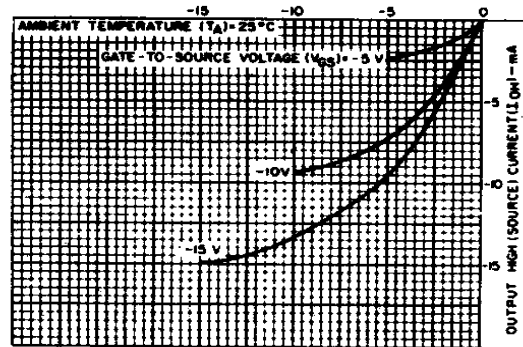

Figure 8. Minimum Output High (Source) Current Characteristics

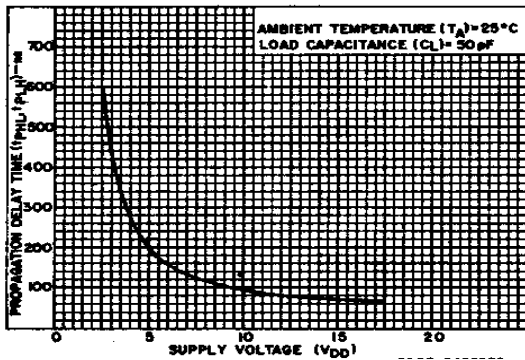

Figure 9. Typical Propagation Delay Time vs Supply Voltage

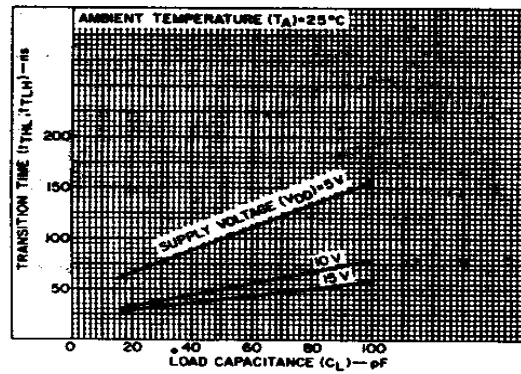

Figure 10. Typical Transition Time vs Load Capacitance

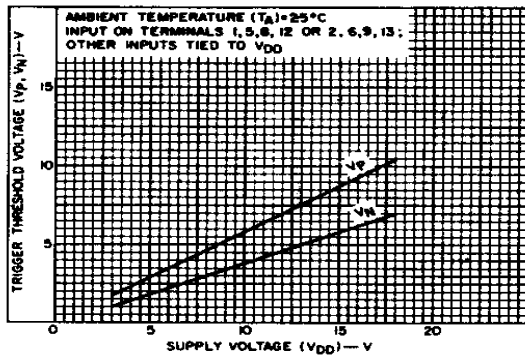

Figure 11. Typical Trigger Threshold Voltage vs V_{DD}

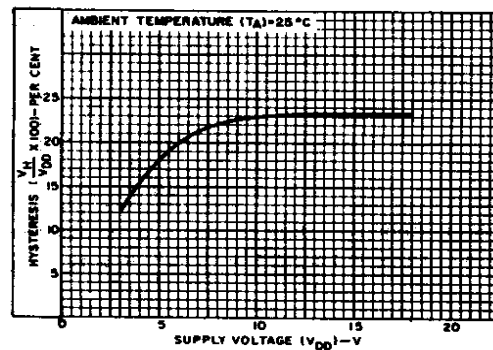

Figure 12. Typical Percent Hysteresis vs Supply Voltage

TYPICAL CHARACTERISTICS

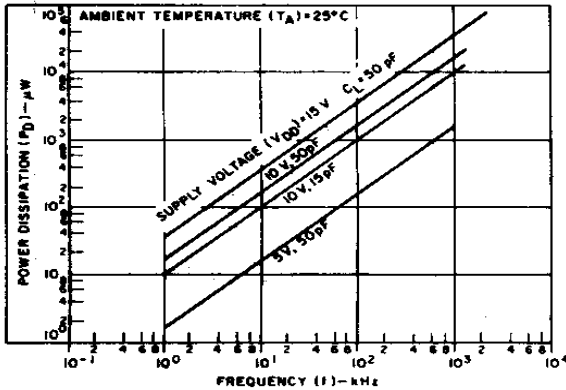

Figure 13. Typical Power Dissipation vs Frequency Characteristics

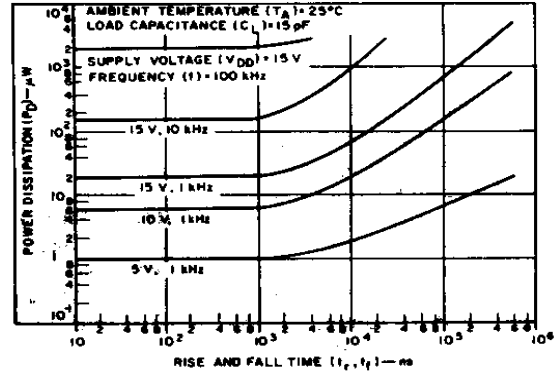
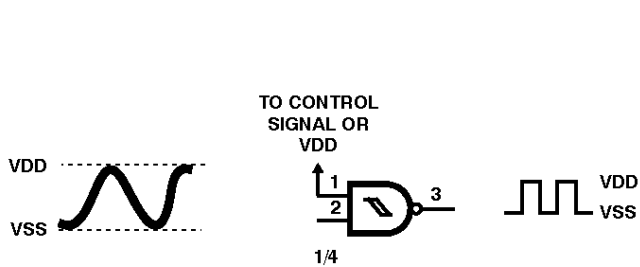

Figure 14. Typical Power Dissipation vs Rise and Fall Times

APPLICATION INFORMATION



FREQUENCY RANGE OF WAVE SHAPE IS FROM DC TO 1MHz

Figure 15. Wave Shaper

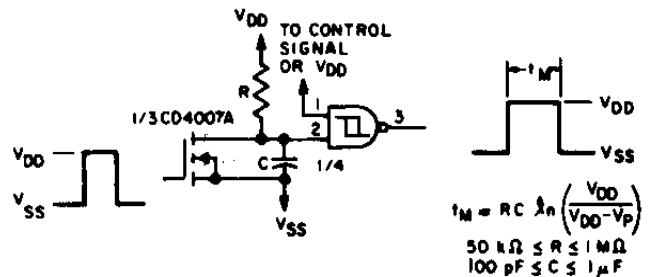

FOR THE RANGE OF R AND C GIVEN $5\mu s < t_M < 1s$

Figure 16. Monostable Multivibrator

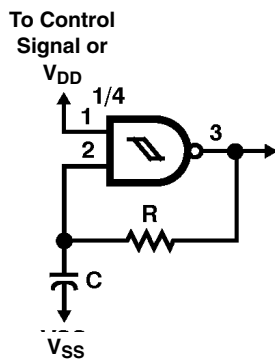

$$t_A = RC \ln \left[\left(\frac{V_P}{V_N} \right) \left(\frac{V_{DD} - V_N}{V_{DD} - V_P} \right) \right]$$

50 kΩ ≤ R ≤ 1 MΩ
100 pF ≤ C ≤ 1 μF
For the Range of R and C
Given 2 ms < t_A < 0.4 s

Figure 17. Astable Multivibrator

CD4093B-Q1

CMOS QUAD 2-INPUT NAND SCHMITT TRIGGER

SCLS608A – MARCH 2005 – REVISED APRIL 2008

absolute maximum ratings over operating free-air temperature range (unless otherwise noted)[†]

DC supply voltage range, V_{DD}	–0.5 V to 20 V
Input voltage range, V_I , all inputs	–0.5 V to $V_{DD} + 0.5$ V
DC input current, any one input	±10 mA
Package thermal impedance, θ_{JA} (see Note 1)	86°C/W
Device dissipation per output transistor for T_A , all package types	100 mW
Operating temperature range, T_A	–40°C to 125°C
Storage temperature range, T_{stg}	–65°C to 150°C

[†] Stresses beyond those listed under “absolute maximum ratings” may cause permanent damage to the device. These are stress ratings only, and functional operation of the device at these or any other conditions beyond those indicated under “recommended operating conditions” is not implied. Exposure to absolute-maximum-rated conditions for extended periods may affect device reliability.

NOTE 1: The package thermal impedance is calculated in accordance with JESD 51-7.

recommended operating conditions[‡]

	MIN	MAX	UNIT
V_{CC} Supply voltage range (T_A = full package temperature range)	3	18	V

[‡] For maximum reliability, nominal operating conditions should be selected so that operation is always within the given range.



CD4093B-Q1 CMOS QUAD 2-INPUT NAND SCHMITT TRIGGER

SCLS608A – MARCH 2005 – REVISED APRIL 2008

static electrical characteristics

CHARACTERISTIC	CONDITIONS			LIMITS AT INDICATED TEMPERATURES (°C)					UNIT
	V _O (V)	V _I (V)	V _{DD} (V)	-40	85	125	25		
							MIN	TYP†	
Quiescent device current, I _{DD} max		0,5	5	1	30	30	0.02	1	μA
		0,10	10	2	60	60	0.02	2	
		0,15	15	4	120	120	0.02	4	
		0,20	20	20	600	600	0.04	20	
Positive trigger threshold voltage, V _P min		A	5	2.2	2.2	2.2	2.2	2.9	V
		A	10	4.6	4.6	4.6	4.6	5.9	
		A	15	6.8	6.8	6.8	6.8	8.8	
		B	5	2.6	2.6	2.6	2.6	3.3	
		B	10	5.6	5.6	5.6	5.6	7	
		B	15	6.3	6.3	6.3	6.3	9.4	
V _P max		A	5	3.6	3.6	3.6	2.9	3.6	V
		A	10	7.1	7.1	7.1	5.9	7.1	
		A	15	10.8	10.8	10.8	8.8	10.8	
		B	5	4	4	4	3.3	4	
		B	10	8.2	8.2	8.2	7	8.2	
		B	15	12.7	12.7	12.7	9.4	12.7	
Negative trigger threshold voltage, V _N min		A	5	0.9	0.9	0.9	0.9	1.9	V
		A	10	2.5	2.5	2.5	2.5	3.9	
		A	15	4	4	4	4	5.8	
		B	5	1.4	1.4	1.4	1.4	2.3	
		B	10	3.4	3.4	3.4	3.4	5.1	
		B	15	4.8	4.8	4.8	4.8	7.3	
V _N max		A	5	2.8	2.8	2.8	1.9	2.8	V
		A	10	5.2	5.2	5.2	3.9	5.2	
		A	15	7.4	7.4	7.4	5.8	7.4	
		B	5	3.2	3.2	3.2	2.3	3.2	
		B	10	6.6	6.6	6.6	5.1	6.6	
		B	15	9.6	9.6	9.6	7.3	9.6	
Hysteresis voltage, V _H min		A	5	0.3	0.3	0.3	0.3	0.9	V
		A	10	1.2	1.2	1.2	1.2	2.3	
		A	15	1.6	1.6	1.6	1.6	3.5	
		B	5	0.3	0.3	0.3	0.3	0.9	
		B	10	1.2	1.2	1.2	1.2	2.3	
		B	15	1.6	1.6	1.6	1.6	3.5	
V _H max		A	5	1.6	1.6	1.6	0.9	1.6	V
		A	10	3.4	3.4	3.4	2.3	3.4	
		A	15	5	5	5	3.5	5	
		B	5	1.6	1.6	1.6	0.9	1.6	
		B	10	3.4	3.4	3.4	2.3	3.4	
		B	15	5	5	5	3.5	5	

NOTES: A. Inputs on terminals 1, 5, 8, 12 or 2, 6, 9, 13; other inputs to V_{DD}.
 B. Inputs on terminals 1 and 2, 5 and 6, 8 and 9, or 12 and 13; other inputs to V_{DD}.



CD4093B-Q1

CMOS QUAD 2-INPUT NAND SCHMITT TRIGGER

SCLS608A – MARCH 2005 – REVISED APRIL 2008

static electrical characteristics (continued)

CHARACTERISTIC	CONDITIONS			LIMITS AT INDICATED TEMPERATURES (°C)					UNIT	
	V _O (V)	V _I (V)	V _{DD} (V)	-40	85	125	25			
							MIN	TYP†		MAX
Output low (sink) current, I _{OL} min	0.4	0,5	5	0.61	0.42	0.36	0.51	1	mA	
	0.5	0,10	10	1.5	1.1	0.9	1.3	2.6		
	1.5	0,15	15	4	2.8	2.4	3.4	6.8		
Output high (source) current, I _{OH} min	4.6	0,5	5	-0.61	-0.42	-0.36	-0.51	-1	mA	
	2.5	0,5	5	-1.8	-1.3	-1.15	-1.6	-3.2		
	9.5	0,10	10	-1.5	-1.1	-0.9	-1.3	-2.6		
Output voltage low level, V _{OL} max		0,5	5	0.05	0.05	0.05	0	0.05	V	
		0,10	10	0.05	0.05	0.05	0	0.05		
		0,15	15	0.05	0.05	0.05	0	0.05		
Output voltage high level, V _{OH} min		0,5	5	4.95	4.95	4.95	4.95	5	V	
		0,10	10	9.95	9.95	9.95	9.95	10		
		0,15	15	14.95	14.95	14.95	14.95			
Input current, I _{IN} max		0,18	18	±0.1	±1	±1	±10 ⁻⁵	±0.1	µA	

dynamic electrical characteristics

T_A = 25°C, input t_r, t_f = 20 ns, C_L = 50 pF, R_L = 200 kΩ

CHARACTERISTIC	TEST CONDITIONS	V _{DD} (V)	LIMITS			UNIT
			MIN	TYP	MAX	
Propagation delay time, t _{PHL} , t _{PLH}		5		190	380	ns
		10		90	180	
		15		65	130	
Transition time, t _{THL} , t _{TLH}		5		100	200	ns
		10		50	100	
		15		40	80	
Input capacitance, C _{IN}	Any Input			5	7.5	pF



PACKAGING INFORMATION

Orderable Device	Status (1)	Package Type	Package Drawing	Pins	Package Qty	Eco Plan (2)	Lead/Ball Finish	MSL Peak Temp (3)	Op Temp (°C)	Top-Side Markings (4)	Samples
CD4093BQM96G4Q1	ACTIVE	SOIC	D	14	2500	Green (RoHS & no Sb/Br)	CU NIPDAU	Level-1-260C-UNLIM	-40 to 125	CD4093BQ	Samples
CD4093BQM96Q1	ACTIVE	SOIC	D	14	2500	Green (RoHS & no Sb/Br)	CU NIPDAU	Level-1-260C-UNLIM	-40 to 125	CD4093BQ	Samples

(1) The marketing status values are defined as follows:

ACTIVE: Product device recommended for new designs.

LIFEBUY: TI has announced that the device will be discontinued, and a lifetime-buy period is in effect.

NRND: Not recommended for new designs. Device is in production to support existing customers, but TI does not recommend using this part in a new design.

PREVIEW: Device has been announced but is not in production. Samples may or may not be available.

OBSOLETE: TI has discontinued the production of the device.

(2) Eco Plan - The planned eco-friendly classification: Pb-Free (RoHS), Pb-Free (RoHS Exempt), or Green (RoHS & no Sb/Br) - please check <http://www.ti.com/productcontent> for the latest availability information and additional product content details.

TBD: The Pb-Free/Green conversion plan has not been defined.

Pb-Free (RoHS): TI's terms "Lead-Free" or "Pb-Free" mean semiconductor products that are compatible with the current RoHS requirements for all 6 substances, including the requirement that lead not exceed 0.1% by weight in homogeneous materials. Where designed to be soldered at high temperatures, TI Pb-Free products are suitable for use in specified lead-free processes.

Pb-Free (RoHS Exempt): This component has a RoHS exemption for either 1) lead-based flip-chip solder bumps used between the die and package, or 2) lead-based die adhesive used between the die and leadframe. The component is otherwise considered Pb-Free (RoHS compatible) as defined above.

Green (RoHS & no Sb/Br): TI defines "Green" to mean Pb-Free (RoHS compatible), and free of Bromine (Br) and Antimony (Sb) based flame retardants (Br or Sb do not exceed 0.1% by weight in homogeneous material)

(3) MSL, Peak Temp. -- The Moisture Sensitivity Level rating according to the JEDEC industry standard classifications, and peak solder temperature.

(4) Multiple Top-Side Markings will be inside parentheses. Only one Top-Side Marking contained in parentheses and separated by a "~" will appear on a device. If a line is indented then it is a continuation of the previous line and the two combined represent the entire Top-Side Marking for that device.

Important Information and Disclaimer: The information provided on this page represents TI's knowledge and belief as of the date that it is provided. TI bases its knowledge and belief on information provided by third parties, and makes no representation or warranty as to the accuracy of such information. Efforts are underway to better integrate information from third parties. TI has taken and continues to take reasonable steps to provide representative and accurate information but may not have conducted destructive testing or chemical analysis on incoming materials and chemicals. TI and TI suppliers consider certain information to be proprietary, and thus CAS numbers and other limited information may not be available for release.

In no event shall TI's liability arising out of such information exceed the total purchase price of the TI part(s) at issue in this document sold by TI to Customer on an annual basis.

OTHER QUALIFIED VERSIONS OF CD4093B-Q1 :

- Catalog: [CD4093B](#)
- Military: [CD4093B-MIL](#)

NOTE: Qualified Version Definitions:

- Catalog - TI's standard catalog product
- Military - QML certified for Military and Defense Applications

D (R-PDSO-G14)

PLASTIC SMALL OUTLINE

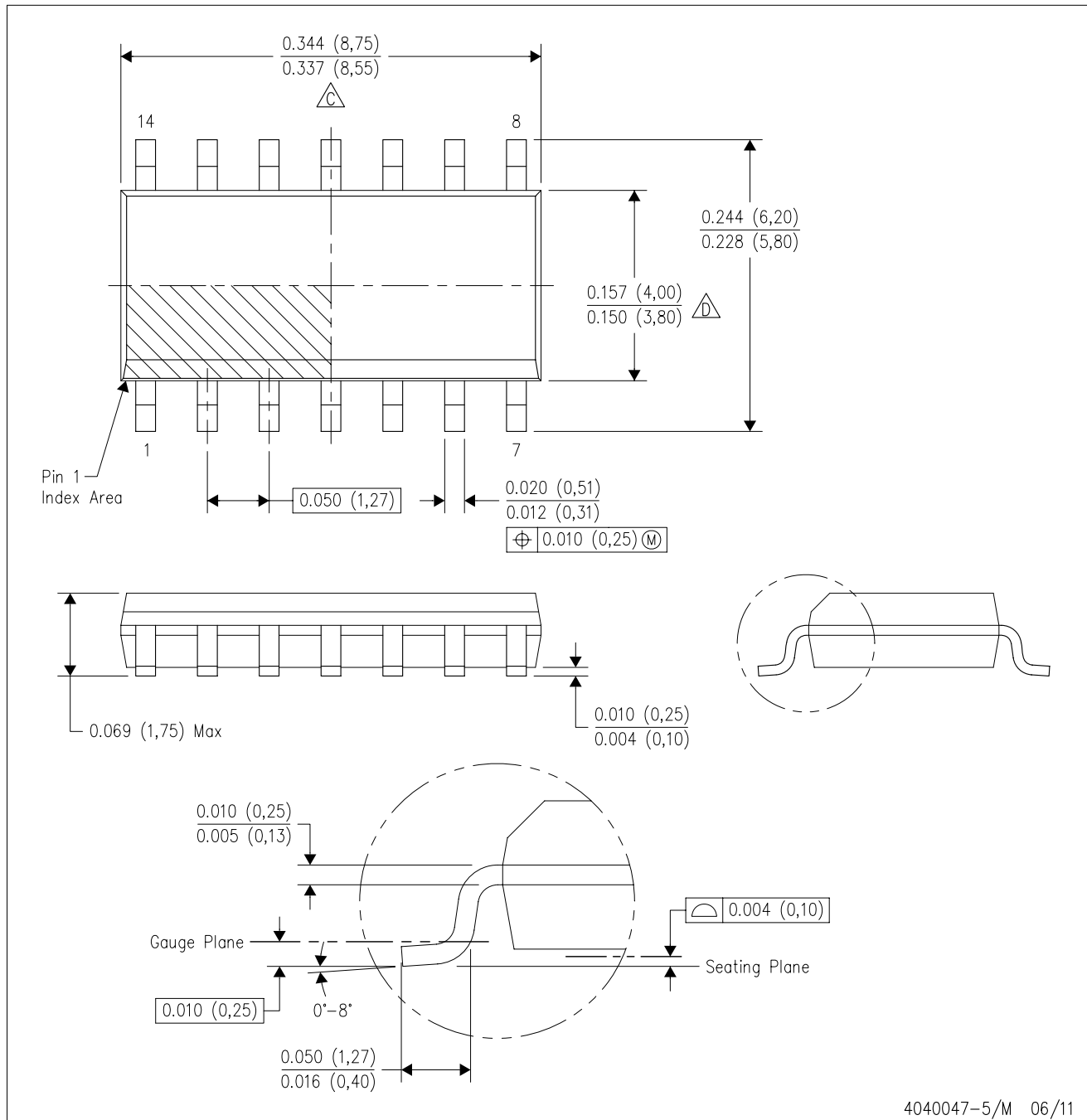

4040047-5/M 06/11

- NOTES:
- A. All linear dimensions are in inches (millimeters).
 - B. This drawing is subject to change without notice.
 - $\triangle C$ Body length does not include mold flash, protrusions, or gate burrs. Mold flash, protrusions, or gate burrs shall not exceed 0.006 (0,15) each side.
 - $\triangle D$ Body width does not include interlead flash. Interlead flash shall not exceed 0.017 (0,43) each side.
 - E. Reference JEDEC MS-012 variation AB.

D (R-PDSO-G14)

PLASTIC SMALL OUTLINE



4211283-3/E 08/12

- NOTES:
- All linear dimensions are in millimeters.
 - This drawing is subject to change without notice.
 - Publication IPC-7351 is recommended for alternate designs.
 - Laser cutting apertures with trapezoidal walls and also rounding corners will offer better paste release. Customers should contact their board assembly site for stencil design recommendations. Refer to IPC-7525 for other stencil recommendations.
 - Customers should contact their board fabrication site for solder mask tolerances between and around signal pads.

IMPORTANT NOTICE

Texas Instruments Incorporated and its subsidiaries (TI) reserve the right to make corrections, enhancements, improvements and other changes to its semiconductor products and services per JESD46, latest issue, and to discontinue any product or service per JESD48, latest issue. Buyers should obtain the latest relevant information before placing orders and should verify that such information is current and complete. All semiconductor products (also referred to herein as "components") are sold subject to TI's terms and conditions of sale supplied at the time of order acknowledgment.

TI warrants performance of its components to the specifications applicable at the time of sale, in accordance with the warranty in TI's terms and conditions of sale of semiconductor products. Testing and other quality control techniques are used to the extent TI deems necessary to support this warranty. Except where mandated by applicable law, testing of all parameters of each component is not necessarily performed.

TI assumes no liability for applications assistance or the design of Buyers' products. Buyers are responsible for their products and applications using TI components. To minimize the risks associated with Buyers' products and applications, Buyers should provide adequate design and operating safeguards.

TI does not warrant or represent that any license, either express or implied, is granted under any patent right, copyright, mask work right, or other intellectual property right relating to any combination, machine, or process in which TI components or services are used. Information published by TI regarding third-party products or services does not constitute a license to use such products or services or a warranty or endorsement thereof. Use of such information may require a license from a third party under the patents or other intellectual property of the third party, or a license from TI under the patents or other intellectual property of TI.

Reproduction of significant portions of TI information in TI data books or data sheets is permissible only if reproduction is without alteration and is accompanied by all associated warranties, conditions, limitations, and notices. TI is not responsible or liable for such altered documentation. Information of third parties may be subject to additional restrictions.

Resale of TI components or services with statements different from or beyond the parameters stated by TI for that component or service voids all express and any implied warranties for the associated TI component or service and is an unfair and deceptive business practice. TI is not responsible or liable for any such statements.

Buyer acknowledges and agrees that it is solely responsible for compliance with all legal, regulatory and safety-related requirements concerning its products, and any use of TI components in its applications, notwithstanding any applications-related information or support that may be provided by TI. Buyer represents and agrees that it has all the necessary expertise to create and implement safeguards which anticipate dangerous consequences of failures, monitor failures and their consequences, lessen the likelihood of failures that might cause harm and take appropriate remedial actions. Buyer will fully indemnify TI and its representatives against any damages arising out of the use of any TI components in safety-critical applications.

In some cases, TI components may be promoted specifically to facilitate safety-related applications. With such components, TI's goal is to help enable customers to design and create their own end-product solutions that meet applicable functional safety standards and requirements. Nonetheless, such components are subject to these terms.

No TI components are authorized for use in FDA Class III (or similar life-critical medical equipment) unless authorized officers of the parties have executed a special agreement specifically governing such use.

Only those TI components which TI has specifically designated as military grade or "enhanced plastic" are designed and intended for use in military/aerospace applications or environments. Buyer acknowledges and agrees that any military or aerospace use of TI components which have **not** been so designated is solely at the Buyer's risk, and that Buyer is solely responsible for compliance with all legal and regulatory requirements in connection with such use.

TI has specifically designated certain components as meeting ISO/TS16949 requirements, mainly for automotive use. In any case of use of non-designated products, TI will not be responsible for any failure to meet ISO/TS16949.

Products

Audio	www.ti.com/audio
Amplifiers	amplifier.ti.com
Data Converters	dataconverter.ti.com
DLP® Products	www.dlp.com
DSP	dsp.ti.com
Clocks and Timers	www.ti.com/clocks
Interface	interface.ti.com
Logic	logic.ti.com
Power Mgmt	power.ti.com
Microcontrollers	microcontroller.ti.com
RFID	www.ti-rfid.com
OMAP Applications Processors	www.ti.com/omap
Wireless Connectivity	www.ti.com/wirelessconnectivity

Applications

Automotive and Transportation	www.ti.com/automotive
Communications and Telecom	www.ti.com/communications
Computers and Peripherals	www.ti.com/computers
Consumer Electronics	www.ti.com/consumer-apps
Energy and Lighting	www.ti.com/energy
Industrial	www.ti.com/industrial
Medical	www.ti.com/medical
Security	www.ti.com/security
Space, Avionics and Defense	www.ti.com/space-avionics-defense
Video and Imaging	www.ti.com/video

TI E2E Community

e2e.ti.com