

深圳市维拓精电科技有限公司

WTL International Limited

APPROVAL SHEET

DESCRIPTION :	3.2*2.5mm 4 Pad SMD Crystal			
NOMINAL FREQ.:	32.000 MHz			
WTL P/N:	WTL3M85396FO			
VERSION:	2			
DATE:	2022.10.12			
Customer	Customer P/N			
Promelectronica	/			
Customer Signature	WTL			
	Approved by: <i>Kavin Liu</i>			
	Checked by: <i>Shu Ping</i>			
	Issued by: <i>colin zhan</i>			
REVISION HISTORY				
Revised Page	Revision Content	Date	Ref. No.	Reviser



CONTENT CATALOG

APPROVAL SHEET	P. 1
CONTENT CATALOG	P. 2
ELECTRICAL SPECIFICATIONS	P. 3
DIMENSIONS	P. 4
MARKING	P. 4
STRUCTURE ILLUSTRATION	P. 5
RELIABILITY SPECIFICATIONS	P. 6
SUGGESTED REFLOW PROFILE	P. 7
SUBSTANCES IN PRODUCT	P. 7
PACKING SPECIFICATIONS	P. 8
WTL PART NUMBER SYSTEM	P. 9

Attachment(s):

- 1.Product Specification Sheet
- 2.Electrical Testing Report
- 3.Reliability Report
- 4.ICP Test Report (SGS)

FEATURE

- Size 3.2×2.5 , Ultra thin, thickness 0.7mm
- High precision and high frequency stability
- Excellent heat resistance and environmental characteristics
- Designed for automatic mounting and reflow soldering
- RoHS Compliant / Pb Free

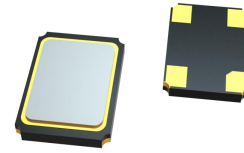

1、 ELECTRICAL SPECIFICATIONS

Hold Style	3225 Seam
Nominal Frequency	32.000 MHz
Mode	Fundamental / AT
Frequency Tolerance (at 25°C)	±10ppm
Frequency Stability Over Operating Temperature Characteristics	±10ppm
Operating Temperature Range	-40°C ~ +85°C
Storage Temperature Range	-55°C ~ +125°C
Shunt Capacitance (C ₀)	5.0pF Max
Driver Level (Typical)	100μW
Load Capacitance(C _L)	10pF
ESR	60Ω Max
Insulation Resistance	More than 500Mohms at DC100V
Aging @25°C 1 st year (Max)	±3ppm/year

REMARK: SPECIFICATIONS SUBJECT TO CHANGE WITHOUT PRIOR NOTICE. PLEASE CONFIRM WITH OUR SALES ENGINEER.

2、DIMENSIONS (Unit: mm)

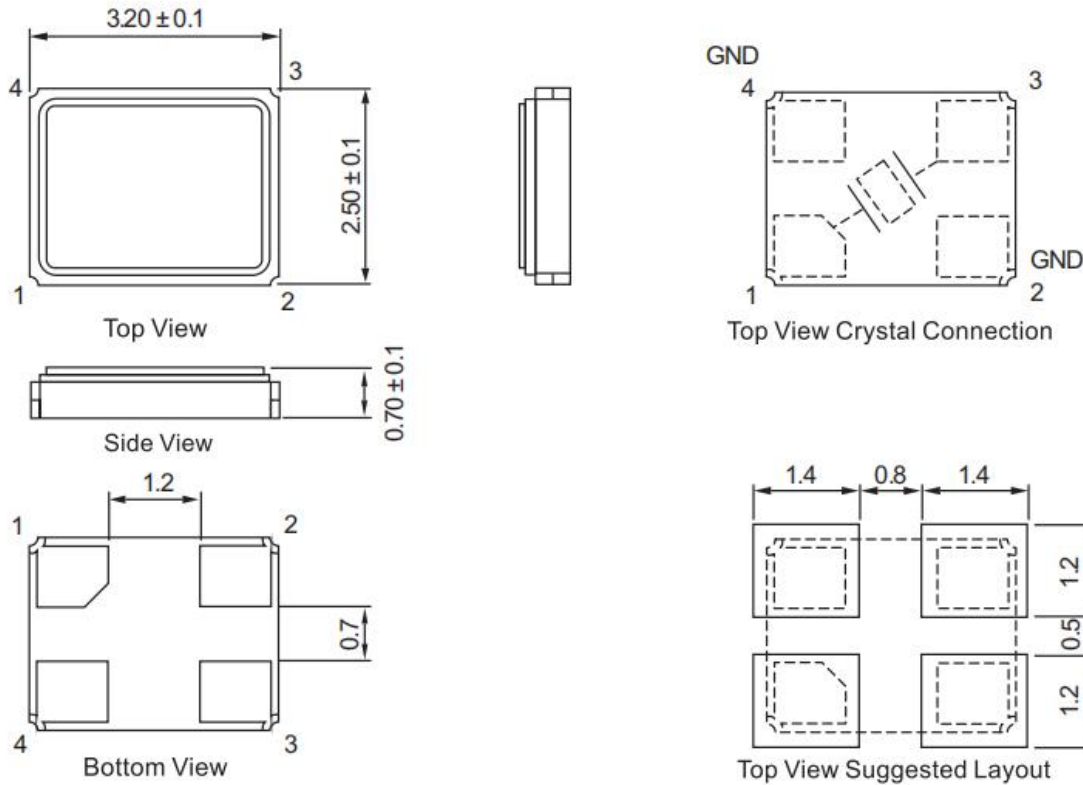

3、MARKING

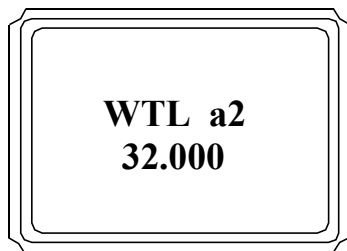

Marking Instruction :

The date code was marked on the crystal body, which will be easily traced back in case of quality issue.

4、STRUCTURE ILLUSTRATION

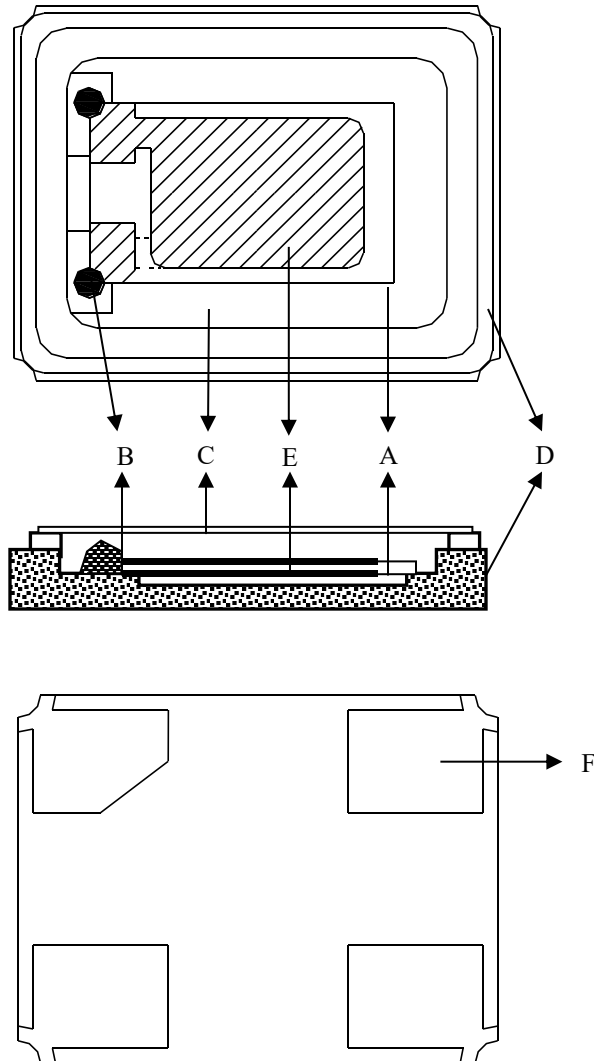

Parts		Material	QTY	COLOR
A	Blank	Mostly SiO ₂	1	White
B	Conductive paste	Ag:80%, silicone resin 10%	2	Greyish
C	Lid	Fe:52~56%,Ni:16~18%,Co:28~30%	1	Silvery
D	Package	Ceramic	1	Brown
E	Plating(blank)	Ag:99.99%	2	Silvery
F	Pad	Cu:6.6%,Au:0.2%,Fe:56%,Ni:18%	4	Golden

5、RELIABILITY SPECIFICATIONS

Item	Conditions	Result
Low Temp. Storage	Put the crystal into the $-40^{\circ}\text{C} \pm 2^{\circ}\text{C}$ constant temperature box for 500 ± 2 H , Measurement taken after 2 hour.	$\Delta F \cong \pm 5$ PPM $\Delta RR \cong \pm 15\%$
High Temp. Storage	Put the crystal into the $+100^{\circ}\text{C} \pm 2^{\circ}\text{C}$ constant temperature box for 500 ± 2 H, Measurement taken after 2 hour.	$\Delta F \cong \pm 5$ PPM $\Delta RR \cong \pm 15\%$
High Temp & Humidity	Put the crystal into the constant temperature & humid with the temperatures $85^{\circ}\text{C} \pm 3^{\circ}\text{C}$ and the humidity 98% for 500 ± 2 H. Measurement taken after 2 hour.	$\Delta F \cong \pm 5$ PPM $\Delta RR \cong \pm 15\%$
Thermal Shock	Put the crystal into the constant temperature $-55^{\circ}\text{C} \pm 2^{\circ}\text{C}$ for 30 ± 1 M, then change the temperature to $+85^{\circ}\text{C} \pm 2^{\circ}\text{C}$ for 30 ± 1 M, the total is 100times. Measurement taken after 2 hour.	$\Delta F \cong \pm 5$ PPM $\Delta RR \cong \pm 15\%$
Resistance To Soldering Heat	Passed through the re-flow oven under the following condition. Preheat to $150^{\circ}\text{C} \pm 5^{\circ}\text{C}$ for 60 to 120sec, and peak $265^{\circ}\text{C} \pm 5^{\circ}\text{C}$ for $10 \text{s} \pm 3 \text{sec}$. Measurement taken after DUT being left at room temperature for at 24 ± 2 hours	$\Delta F \cong \pm 5$ PPM $\Delta RR \cong \pm 15\%$
Drop Test	The crystal fall off the cement floor with the height $100 \text{cm} \pm 5 \text{cm}$ for 3 times. Measurement taken after 2 hour.	$\Delta F \cong \pm 5$ PPM $\Delta RR \cong \pm 15\%$
Vibration Test	Apply 0.75mm vibration at sweep frequency $10 \sim 500$ Hz, for 2h. 10 cycles in each direction of 3 axis. Measurement taken after 2 hour.	$\Delta F \cong \pm 5$ PPM $\Delta RR \cong \pm 15\%$
Shock	Peak 1000m/s^2 , normal width 6ms half sine wave form, 3.7m/s , 3 perpendicular axis of samples, 3 cycles / direction, total 18 cycles. Measurement taken after 2 hour.	$\Delta F \cong \pm 5$ PPM $\Delta RR \cong \pm 15\%$
Fine Leak	Helium Bombing 4.5kgf/cm^2 for 2 hr	Less than $1 * 10^{-8} \text{atm.c.c./sec}$, Helium
Solder ability	In $245 \pm 5^{\circ}\text{C}$ solder bath for 2 ± 0.5 seconds. 8-12X magnifier.	Terminals shall be covered more then 95% with solder.

6、SUGGESTED REFLOW PROFILE

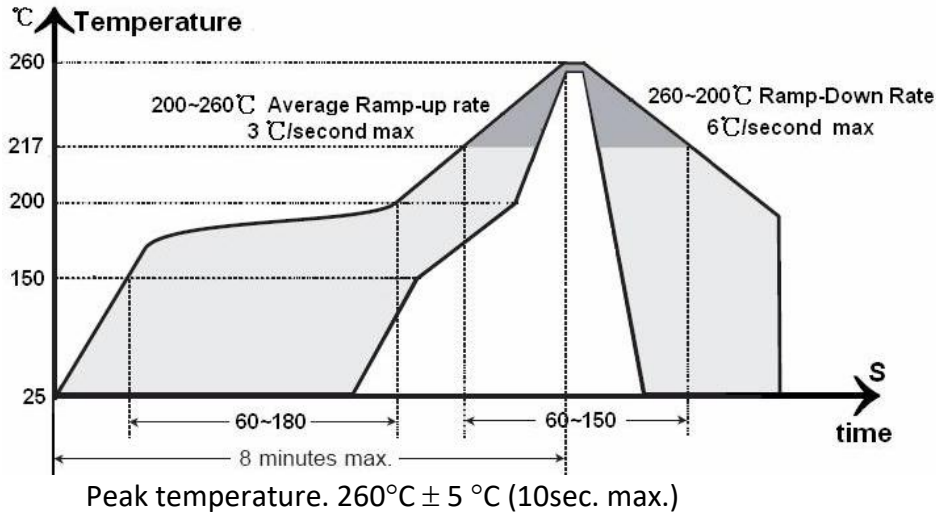

7、SUBSTANCES IN PRODUCT

Drawing number	Disassembly Unit/component description	Homogeneous Material Name.	Substance Name	CAS No.	Substance Mass. (mg)	Content Rate(%)per
SMD3225	Crystal blank	Quartz	SiO ₂	14808-60-7	0.2543	100.00%
	Electrode	Electrode-Ag	Ag	7440-22-4	0.0585	100.00%
	Package	Ceramics	Al ₂ O ₃	1344-28-1	8.1990	90.00%
			Mn ₂ O ₃	1317-34-6	0.3644	4.00%
			SiO ₂	7631-86-9	0.3644	4.00%
			MoO ₃	1313-27-5	0.0911	1.00%
			MgO	1309-48-4	0.0911	1.00%
			Kovar ring	Fe	7439-89-6	0.1061
		Ni		7440-02-0	0.0581	29.00%
		Co		7440-48-4	0.0360	18.00%
		Plate		Au	7440-57-5	0.0571
			Ni	7440-02-0	0.2433	81.00%
	Metallizing	Mo	7439-98-7	0.1001	100.00%	
		Solder	Ag	7440-22-4	0.2132	71.00%
			Cu	7440-50-8	0.0871	29.00%
		Lid	Kovar	Fe	7439-89-6	3.4096
	Ni			7440-02-0	2.4605	35.00%
	Co			7440-48-4	1.1248	16.00%
	Mn			7439-96-5	0.0352	0.50%
	Conduct Adhesive	siliver adhesive	Ag	7440-22-4	0.1540	70.00%
			Pd	7440-05-3	0.0110	5.00%
C ₁₁ H ₂₄			1120-21-4	0.0220	10.00%	
C ₁₂ H ₂₆			112-40-3	0.0110	5.00%	
SiO ₂			7631-86-9	0.0220	10.00%	

All the products we provide meet the requirements of RoHS and Reach regulations, and we send SGS for ICP test every year.

8、PACKING SPECIFICATIONS (Unit: mm)

TAPE SPECIFICATION

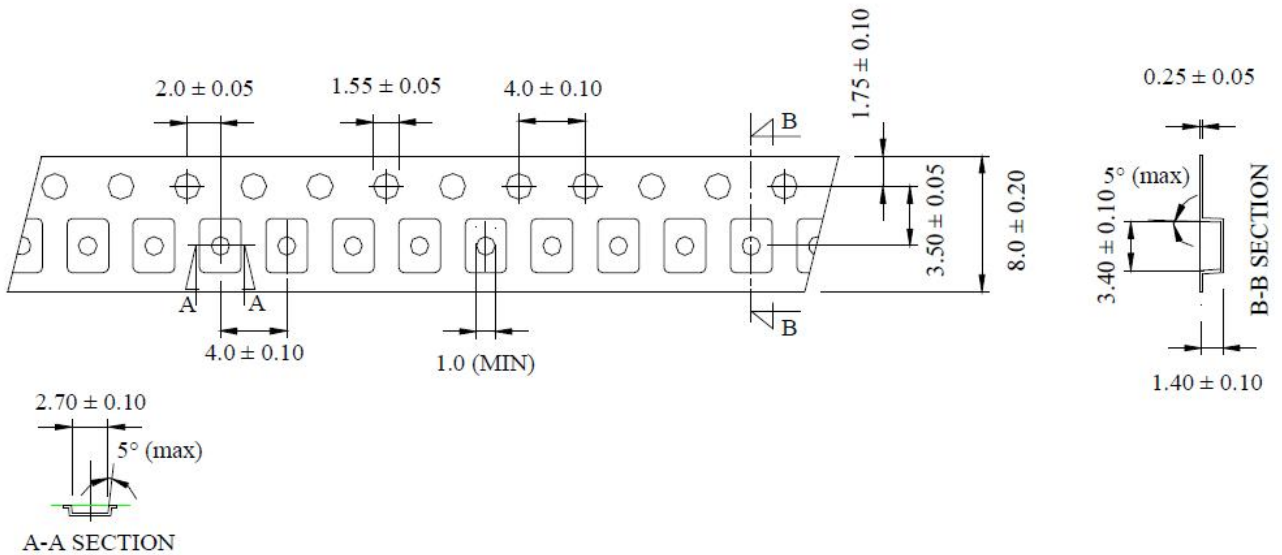

OUTLINE DIMENSION

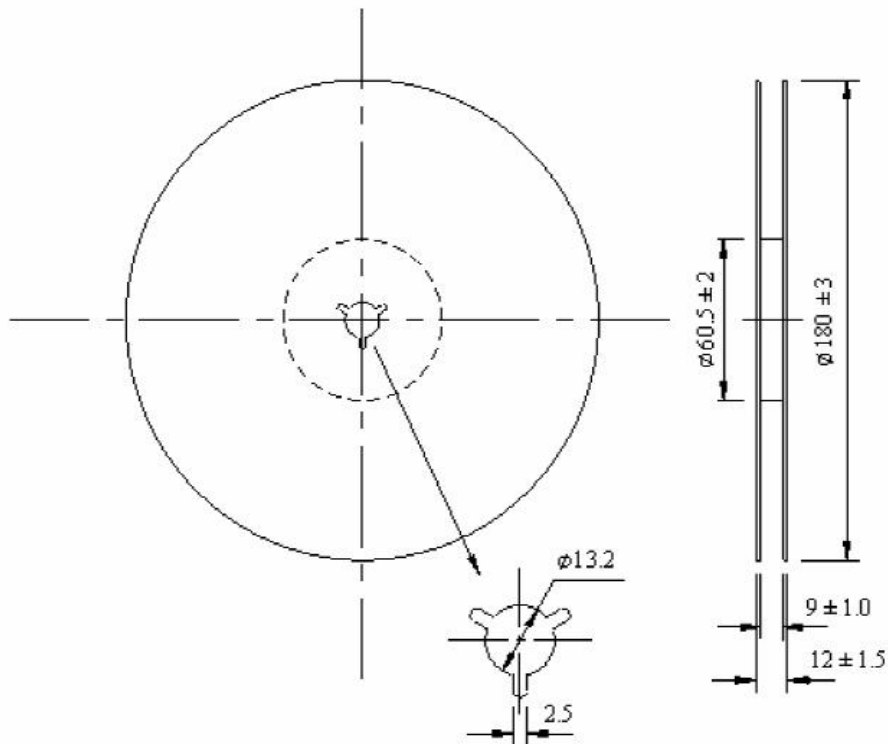

Q'ty: 3000pcs/Reel

9、WTL PART NUMBER SYSTEM :

For example: WTL3M85396FO

[Instructions: for project management, WTL will trace back the part number to developer wherever it goes]

WTL - 3M - 85396 - FO

WTL: Brand

3M : Package Code

85396: Serial number, flow code, without any rules

FO: WTL Developer Code, for example: VH,CH,PZ,RZ,ML