

**LOW VOLTAGE MOSFET (P-CHANNEL)**
**FEATURES**

- $V_{DS}=-30V, R_{DS(ON)}\leq 10m\Omega @V_{GS}=-10V, I_D=-10A$
- Ultra Low on-resistance
- For Low power DC to DC converter application
- For Load switch application
- Surface Mount device

**MECHANICAL DATA**

- Case: PDFN3333
- Case Material: Molded Plastic. UL flammability
- Classification Rating: 94V-0
- Weight: 0.012 grams (approximate)
- Marking:Q30P03

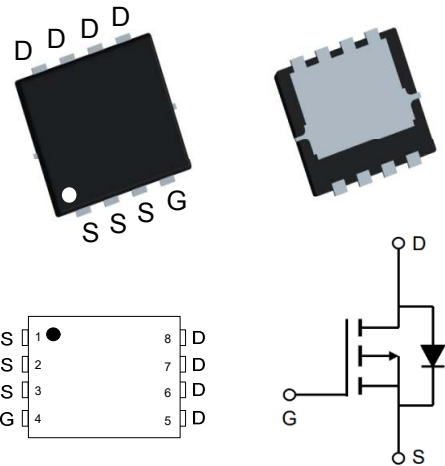

PDFN3333

**MAXIMUM RATINGS ( $T_A = 25^\circ C$  unless otherwise noted)**

Symbol	Parameter	Rating	Units
$V_{DS}$	Drain-Source Voltage	-30	V
$V_{GS}$	Gate-Source Voltage	$\pm 20$	V
$I_D@T_C=25^\circ C$	Continuous Drain Current <sup>1</sup>	-60	A
$I_D@T_C=100^\circ C$	Continuous Drain Current <sup>1</sup>	-30	A
$I_{DM}$	Pulsed Drain Current <sup>2</sup>	-90	A
EAS	Single Pulse Avalanche Energy <sup>3</sup>	64	mJ
$I_{AS}$	Avalanche Current	30	A
$P_D@T_C=25^\circ C$	Total Power Dissipation <sup>4</sup>	32	W
$T_{STG}$	Storage Temperature Range	-55 to 150	$^\circ C$
$T_J$	Operating Junction Temperature Range	-55 to 150	$^\circ C$

**ELECTRICAL CHARACTERISTICS ( $T_A = 25^\circ C$  unless otherwise specified)**

Symbol	Parameter	Conditions	Min.	Typ.	Max.	Unit
$BV_{DSS}$	Drain-Source Breakdown Voltage	$V_{GS}=0V, I_D=250\mu A$	-30	---	---	V
$R_{DS(ON)}$	Static Drain-Source On-Resistance <sup>2</sup>	$V_{GS}=10V, I_D=10A$		7.4	10	m $\Omega$
		$V_{GS}=4.5V, I_D=10A$		11.4	13.5	m $\Omega$
$V_{GS(th)}$	Gate Threshold Voltage	$V_{GS}=V_{DS}, I_D=250\mu A$	-1.0	-1.6	-2.0	V
$I_{DSS}$	Drain-Source Leakage Current	$V_{DS}=30V, V_{GS}=0V, T_J=25^\circ C$	---	---	-1	$\mu A$
		$V_{DS}=24V, V_{GS}=0V, T_J=125^\circ C$	---	---	-10	$\mu A$
$I_{GSS}$	Gate-Source Leakage Current	$V_{GS}=\pm 20V, V_{DS}=0V$	---	---	$\pm 100$	nA
$R_g$	Gate Resistance	$V_{DS}=0V, V_{GS}=0V, f=1MHz$	---	1.8	---	$\Omega$
$Q_g$	Total Gate Charge (10V)	$V_{DS}=15V, V_{GS}=10V, I_D=20A$	---	81	---	nC
$Q_{gs}$	Gate-Source Charge		---	12	---	
$Q_{gd}$	Gate-Drain Charge		---	9.7	---	
$T_{d(on)}$	Turn-On Delay Time	$V_{DD}=15V, V_{GS}=10V, R_G=3\Omega, I_D=15A$	---	17	---	ns
$T_r$	Rise Time		---	21	---	
$T_{d(off)}$	Turn-Off Delay Time		---	36	---	
$T_f$	Fall Time		---	15	---	
$C_{iss}$	Input Capacitance	$V_{DS}=15V, V_{GS}=0V, f=1MHz$	---	3980	---	pF
$C_{oss}$	Output Capacitance		---	450	---	
$C_{rss}$	Reverse Transfer Capacitance		---	420	---	

**LOW VOLTAGE MOSFET (P-CHANNEL)**

**Typical Characteristics**

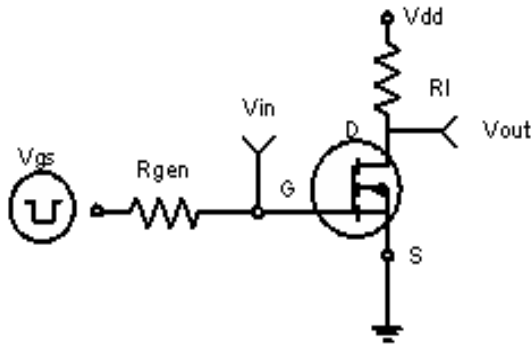

**Figure 1 Switching Test Circuit**

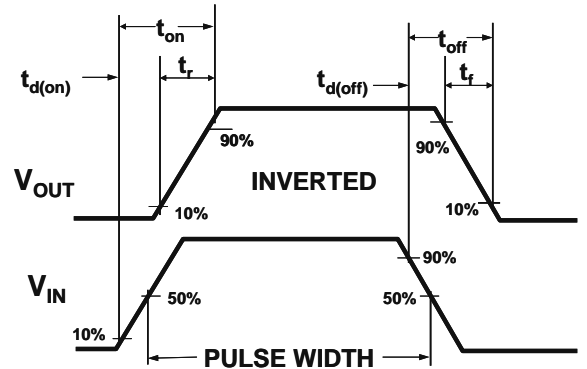

**Figure 2 Switching Waveforms**

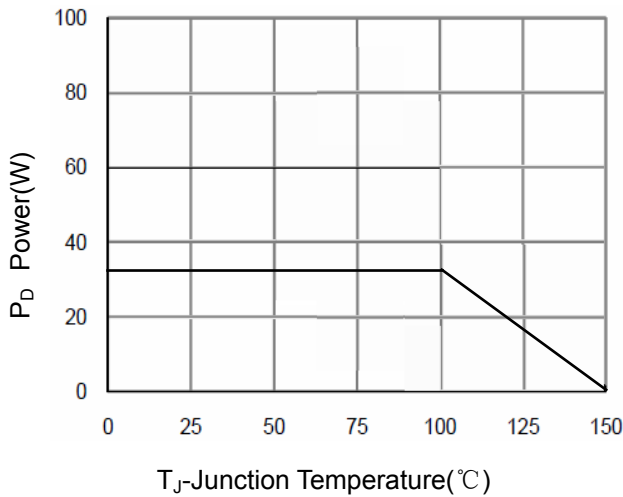

**Figure 3 Power Dissipation**

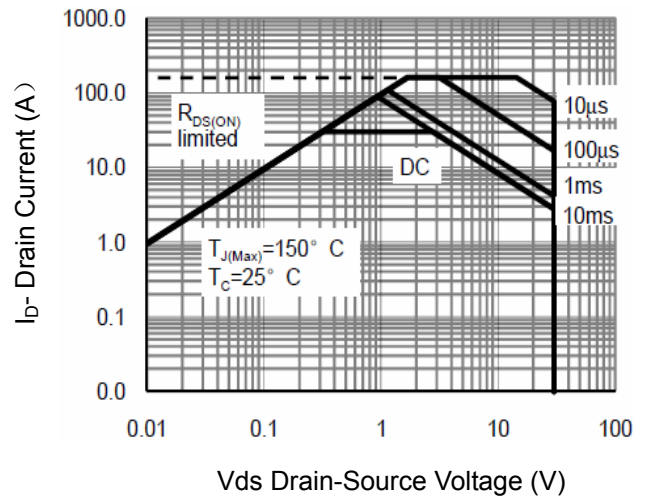

**Figure 4 Safe Operation Area**

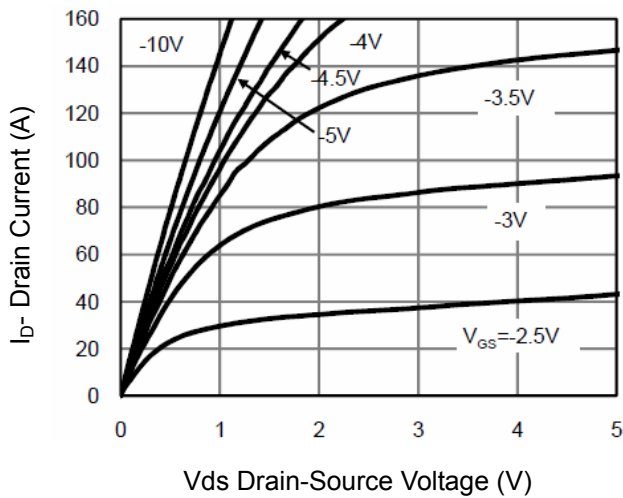

**Figure 5 Output Characteristics**

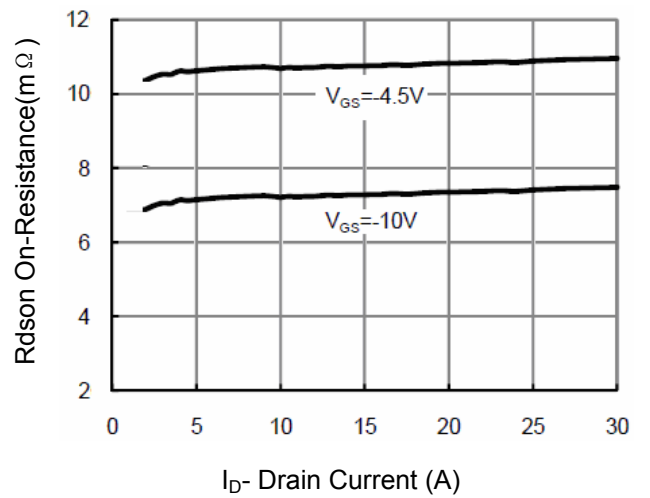

**Figure 6 Drain-Source On-Resistance**

**LOW VOLTAGE MOSFET (P-CHANNEL)**

**Typical Characteristics**

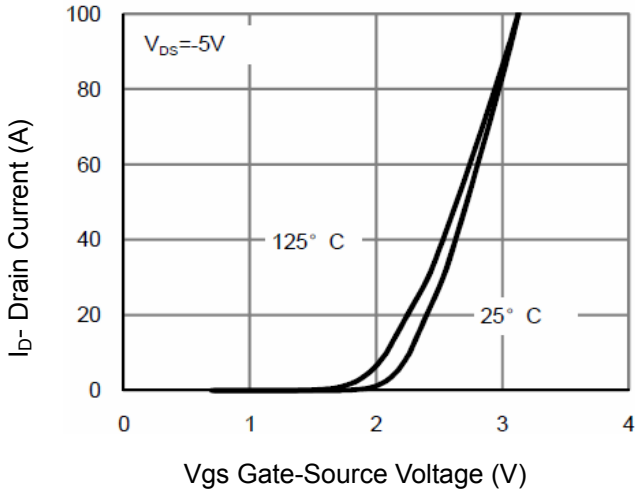

**Figure 7 Transfer Characteristics**

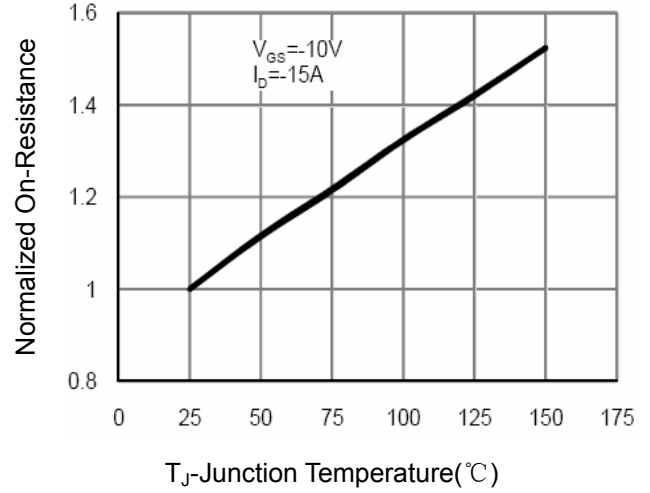

**Figure 8 Drain-Source On-Resistance**

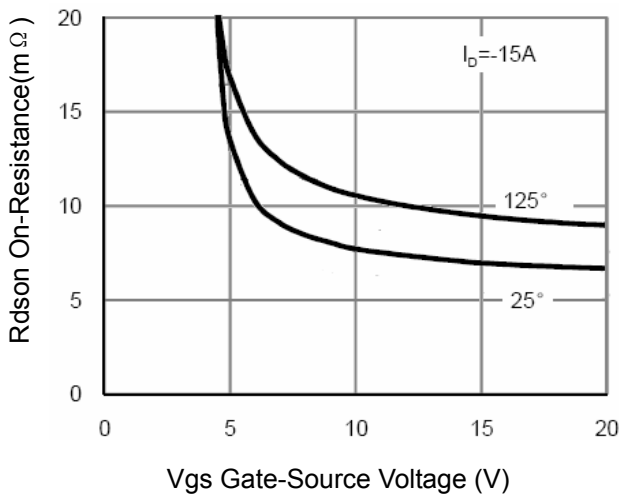

**Figure 9 Rdson vs Vgs**

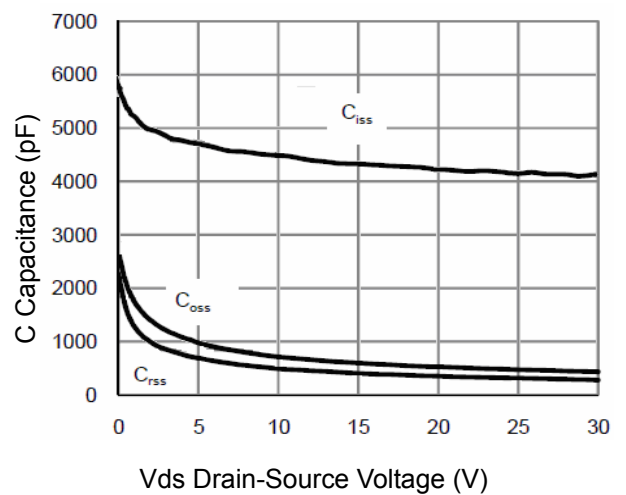

**Figure 10 Capacitance vs Vds**

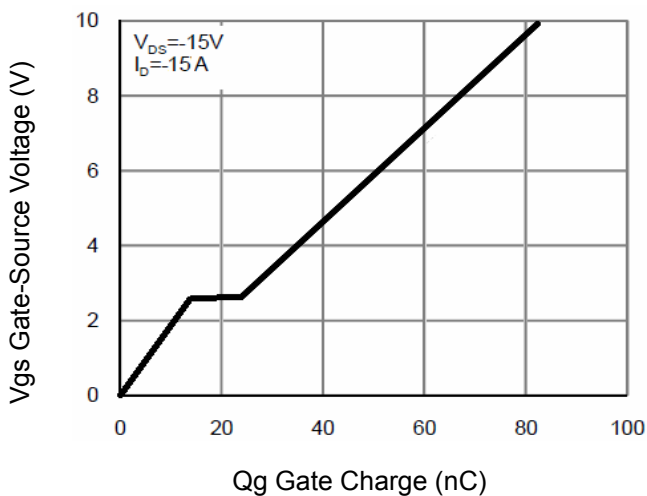

**Figure 11 Gate Charge**

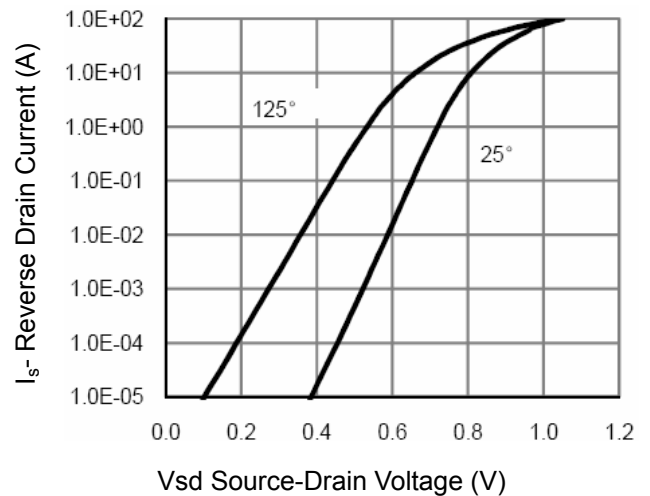

**Figure 12 Source- Drain Diode Forward**

**LOW VOLTAGE MOSFET (P-CHANNEL)**

PDFN3333

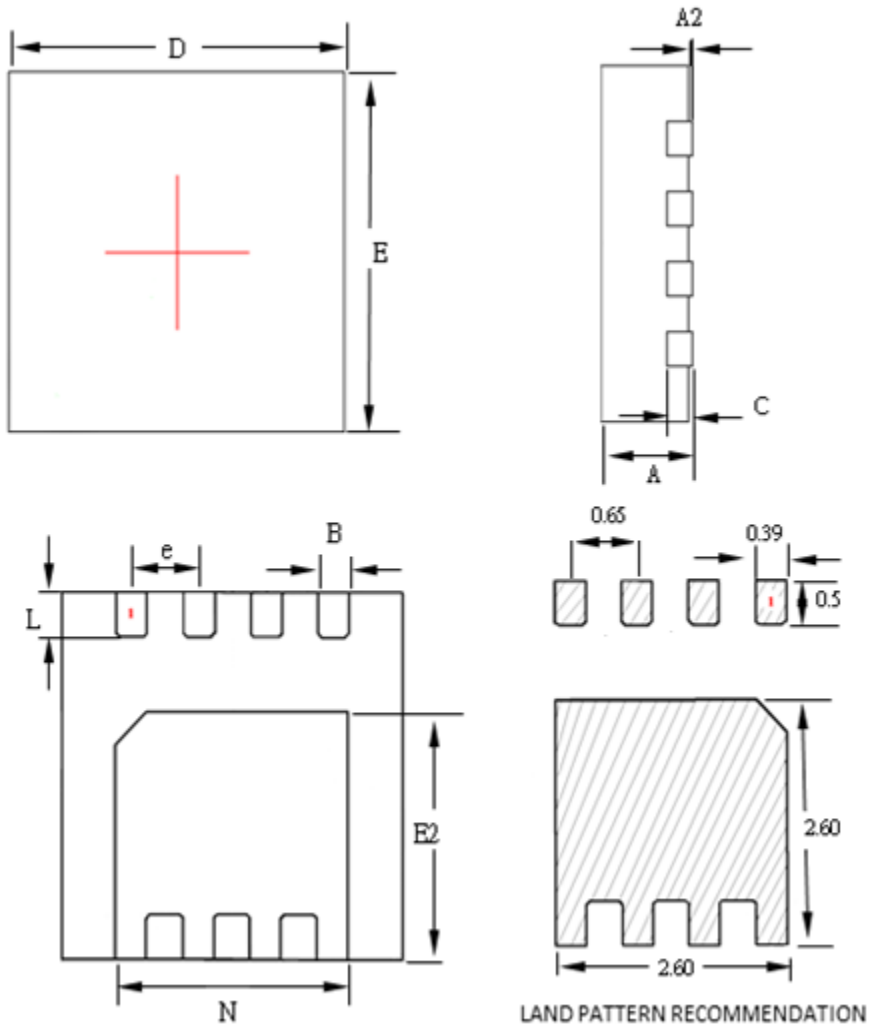

SYMBOLS	MILLIMETERS			INCHES		
	MIN	NOM	MAX	MIN	NOM	MAX
A	0.70	0.75	0.80	0.028	0.030	0.031
A2	0.00	--	0.05	0.000	--	0.002
B	0.24	0.30	0.35	0.009	0.012	0.014
C	0.10	0.15	0.25	0.004	0.006	0.010
D	3.15	3.30	3.40	0.124	0.130	0.134
E	3.15	3.30	3.40	0.124	0.130	0.134
E2	2.15	2.25	2.35	0.085	0.089	0.093
L	0.35	0.40	0.45	0.014	0.016	0.018
N	2.10	2.25	2.35	0.083	0.089	0.093
e	--	0.65	--	--	0.026	--