

## DETAILS

<b>Product Number</b>	C13300_STRADA-2X2-T2
<b>Family</b>	Strada-Module
<b>Type</b>	Lens array
<b>Color</b>	clear
<b>Diameter</b>	50 + 50 mm
<b>Height</b>	7,7 mm
<b>Style</b>	square
<b>Optic Material</b>	PMMA
<b>Holder Material</b>	
<b>Fastening</b>	glue, pin, screw
<b>Status</b>	production ready
<b>ROHS Compliant</b>	Yes
<b>Date Updated</b>	27/09/2016



## OPTICAL PROPERTIES

LED	Viewing	Light	Effi-	cd/lm	Connector
	Angle	Beam	ciency		
XT-E	Asymmetric deg	Asymmetric	93 %	-	-
XP-G	Asymmetric deg	Asymmetric	94 %	1.100	-
XM-L	Asymmetric deg	Asymmetric	95 %	0.800	-
XB-D	Asymmetric deg	Asymmetric	94 %	1.100	-
XP-G2	Asymmetric deg	Asymmetric	91 %	1.000	-
XM-L2	Asymmetric deg	Asymmetric	94 %	0.700	-
XB-H	sim: Asymmetric	Asymmetric	sim: 91 %	-	-
XP-L	asymmetric deg	Asymmetric	94 %	0.830	-
XP-L HI	asymmetric deg	Asymmetric	94 %	1.100	-
XHP35 HD	sim: Asymmetric	Asymmetric	sim: 90 %	-	-
XHP35 HI	sim: Asymmetric	Asymmetric	sim: 92 %	-	-
XP-L2	Asymmetric deg	Asymmetric	94 %	0.760	-
H35C0 (LEMWA33)	Asymmetric deg	Asymmetric	94 %	1.000	-
H35C1 (LEMWA33)	Asymmetric deg	Asymmetric	94 %	1.000	-
LUXEON R	Asymmetric deg	Asymmetric	94 %	1.000	-
LUXEON Rebel ES	Asymmetric deg	Asymmetric	94 %	1.100	-
LUXEON T	Asymmetric deg	Asymmetric	94 %	1.100	-
LUXEON Z ES	Asymmetric deg	Asymmetric	94 %	1.500	-
LUXEON H50-2	sim: Asymmetric	Asymmetric	-	-	-
LUXEON Q	asymmetric deg	Asymmetric	94 %	1.100	-
LUXEON MZ	asymmetric deg	Asymmetric	94 %	1.000	-
LUXEON TX	asymmetric deg	Asymmetric	94 %	1.000	-
LUXEON 5050	Asymmetric deg	Asymmetric	94 %	0.770	-
NVSxx19A	Asymmetric deg	Asymmetric	-	-	-
NCSxx19A	Asymmetric deg	Asymmetric	-	-	-



# PRODUCT DATASHEET

## Strada-Module series

last update 27/9/2016

### OPTICAL PROPERTIES

LED	Viewing Angle	Light Beam	Efficiency	cd/lm	Connector
NS9x383	Asymmetric deg	Asymmetric	95 %	0.800	-
NWSx229A	Asymmetric deg	Asymmetric	94 %	0.820	-
NVSxx19B/NVSxx19C	sim: Asym	Asymmetric	sim: 93 %	sim: 0.893	-
NVSW3x9A	Asymmetric deg	Asymmetric	94 %	0.960	-
NVSxE21A	asym deg	Asymmetric	94 %	1.480	-
Oslon Square PC	Asymmetric deg	Asymmetric	94 %	1.000	-
Oslon Square Gen3	Asymmetric deg	Asymmetric	94 %	1.100	-
Duris S8	sim: Asymmetric	Asymmetric	sim: 92 %	sim: 0.710	-
Duris P8	sim: Asymmetric	Asymmetric	sim: 92 %	sim: 0.910	-
Fortimo FastFlex LED board 2x8/740 DA 63	Asymmetric deg	Asymmetric	94 %	1.100	-
LH351B	Asymmetric deg	Asymmetric	94 %	0.950	-
LH351Z	asymmetric deg	Asymmetric	94 %	1.000	-
LH351D	Asymmetric deg	Asymmetric	94 %	0.780	-
Z5P	Asymmetric deg	Asymmetric	-	-	-
Acrich MJT 4040	Asymmetric deg	Asymmetric	94 %	1.000	-
Z5M1/Z5M2	asymmetric deg	Asymmetric	94 %	1.100	-
Z8Y22P	Asymmetric deg	Asymmetric	94 %	0.960	-
TL1L3	Asymmetric deg	Asymmetric	94 %	0.790	-
TL1L4	Asymmetric deg	Asymmetric	93 %	1.000	-
RLE G1 49x223mm 4000lm xxx EXC OT	Asymmetric deg	Asymmetric	94 %	1.100	-
RLE G1 49x245mm 4000lm xxx EXC OT	Asymmetric deg	Asymmetric	94 %	1.100	-
RLE G1 49x121mm 2000lm xxx EXC OT	Asymmetric deg	Asymmetric	94 %	1.100	-
RLE G1 49x133mm 2000lm xxx EXC OT	Asymmetric deg	Asymmetric	94 %	1.100	-

D C B A

4

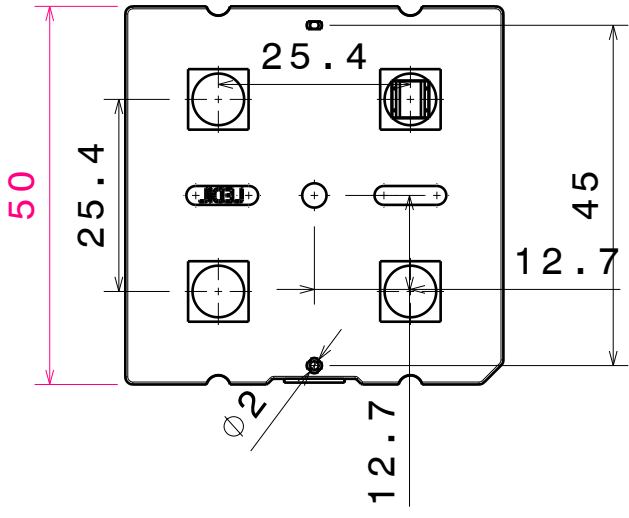

Bottom view

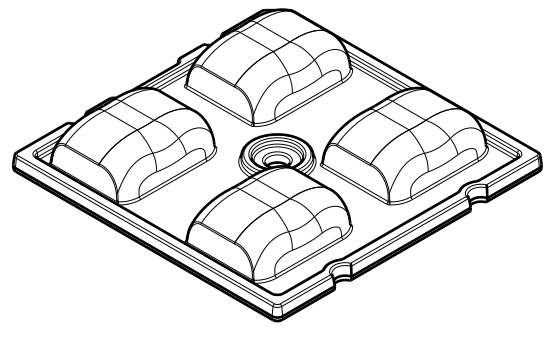

Isometric view

3

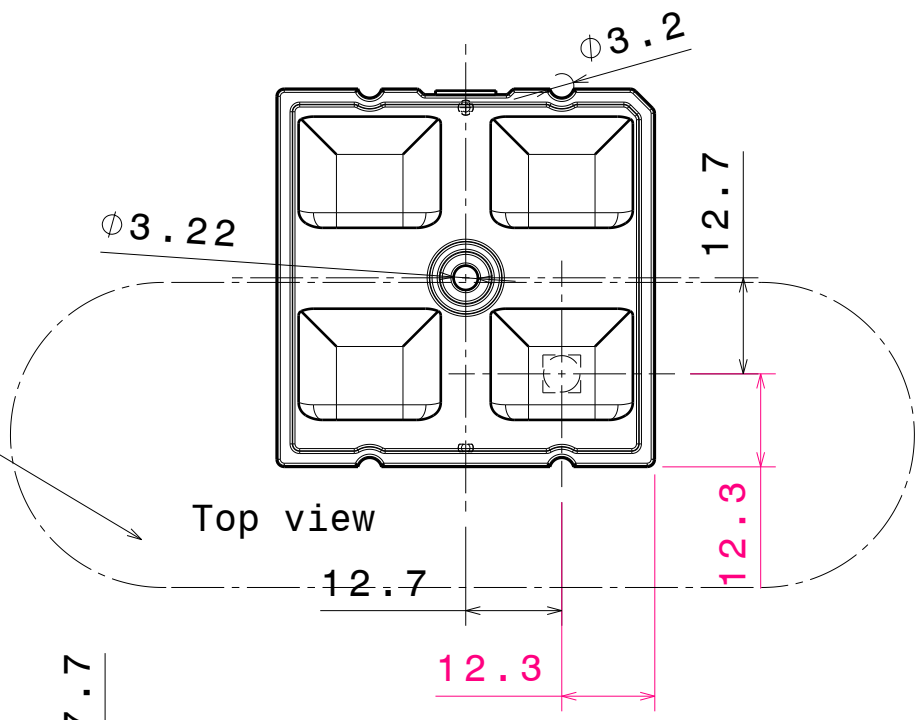

Top view

Beam Direction

2

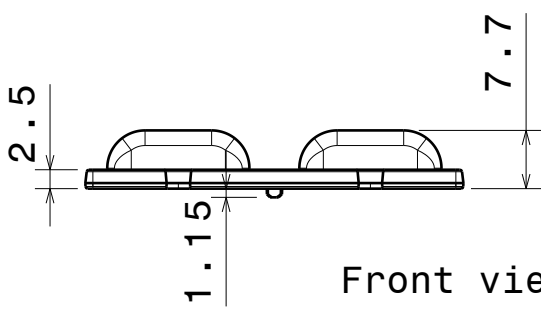

Front view

4

3

2

INDEX	PART NO	DESCRIPTION	MATERIAL	COLOUR
1	C13300	STRADA-2X2-T2	PMMA	

Tolerances if not otherwise shown  
According to DIN ISO 2768-1  
Linear measures:  
Up to 30mm class M, otherwise class C.  
According to DIN ISO 2768-2  
Form and position: class L

**LEDiL** LediL Oy  
Salorankatu 10  
FIN 24240 SALO  
Finland

THIRD ANGLE PROJECTION:

DRAWING TITLE  
**STRADA-2X2-T2**

This drawing is the property of LEDiL Oy. It may not be reproduced, copied or communicated without a written agreement with LEDiL Oy."

SIZE  
**A4**

**C13300**

SCALE 1:1 WEIGHT SHEET 1/1

1

1

D

A

# LEDiL Oy C13300\_STRADA-2X2-T2\_(XP-G) Eff.97.9% / LDC (Linear)

Luminaire: LEDiL Oy C13300\_STRADA-2X2-T2\_(XP-G) Eff.97.9%  
Lamps: 1 x XP-G (249lm@250mA)

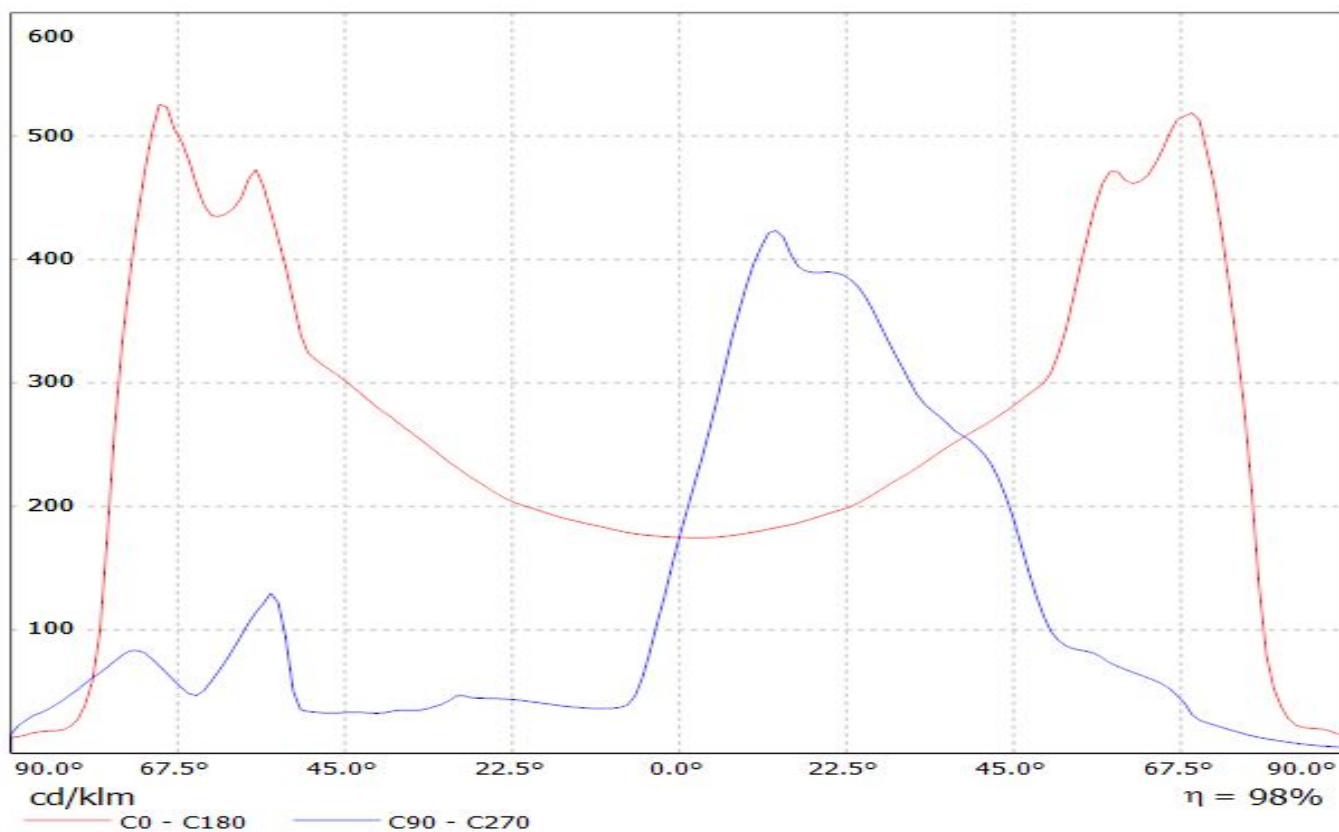

# LEDiL Oy C13300\_STRADA-2X2-T2\_(XM-L) Eff.95.1% / LDC (Linear)

Luminaire: LEDiL Oy C13300\_STRADA-2X2-T2\_(XM-L) Eff.95.1%  
Lamps: 1 x XM-L (357lm@250mA)

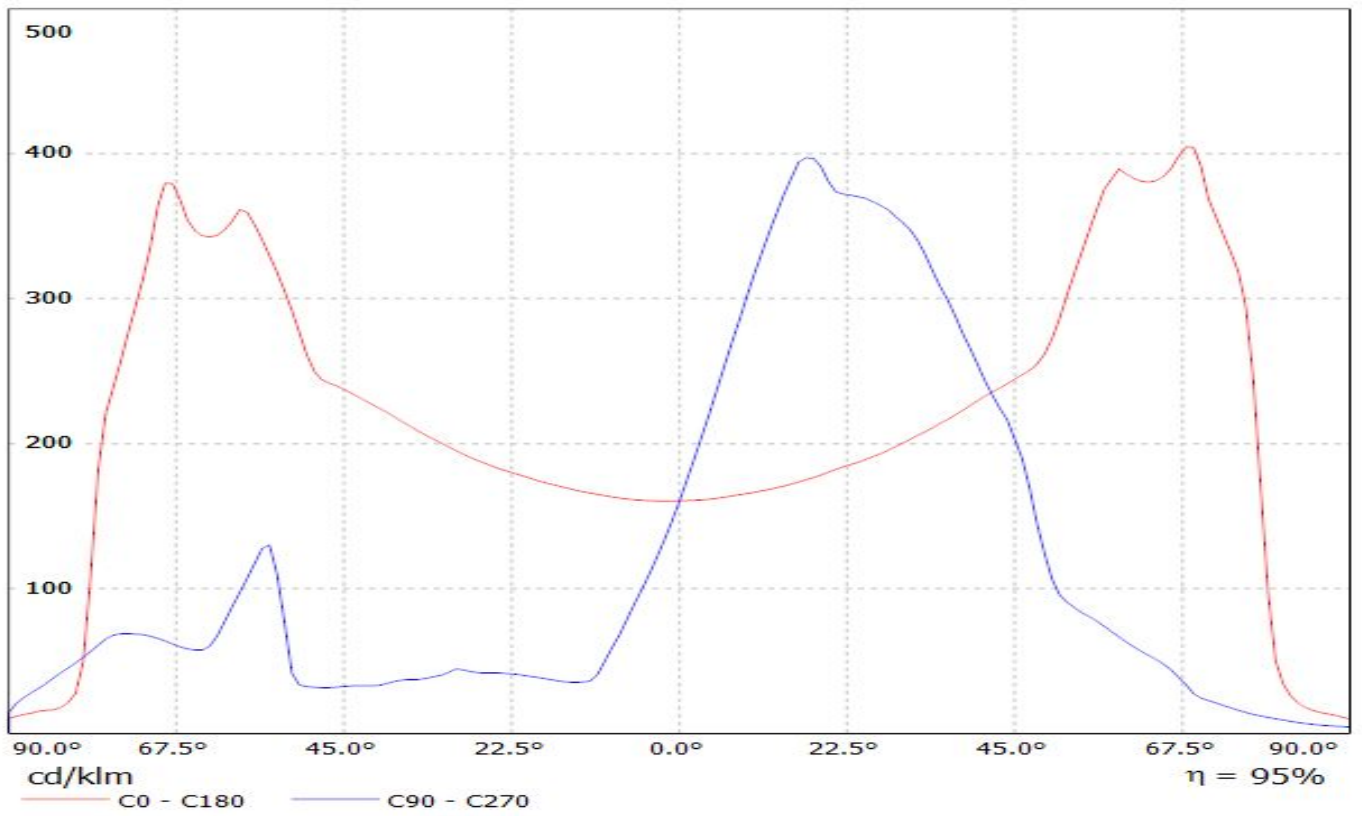

# LEDiL Oy C13300\_STRADA-2X2-T2\_(XB-D) Eff.94.2% / LDC (Linear)

Luminaire: LEDiL Oy C13300\_STRADA-2X2-T2\_(XB-D) Eff.94.2%  
Lamps: 1 x XM-L (370lm@250mA)

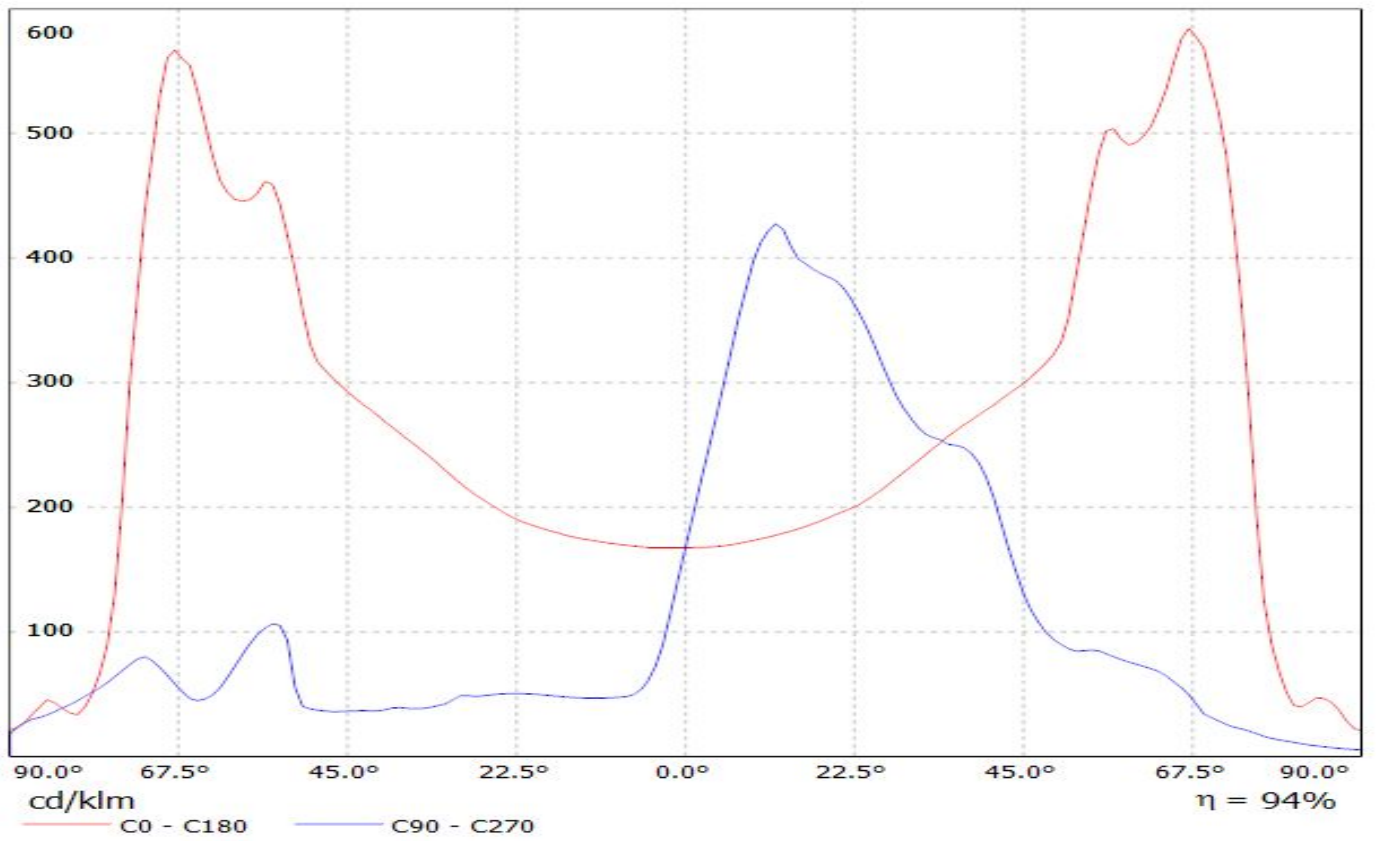

# LEDiL Oy C13300\_STRADA-2X2-T2\_(XP-G2) Eff.90.9% / LDC (Linear)

Luminaire: LEDiL Oy C13300\_STRADA-2X2-T2\_(XP-G2) Eff.90.9%

Lamps: 1 x XP-G2 (433lm@250mA)

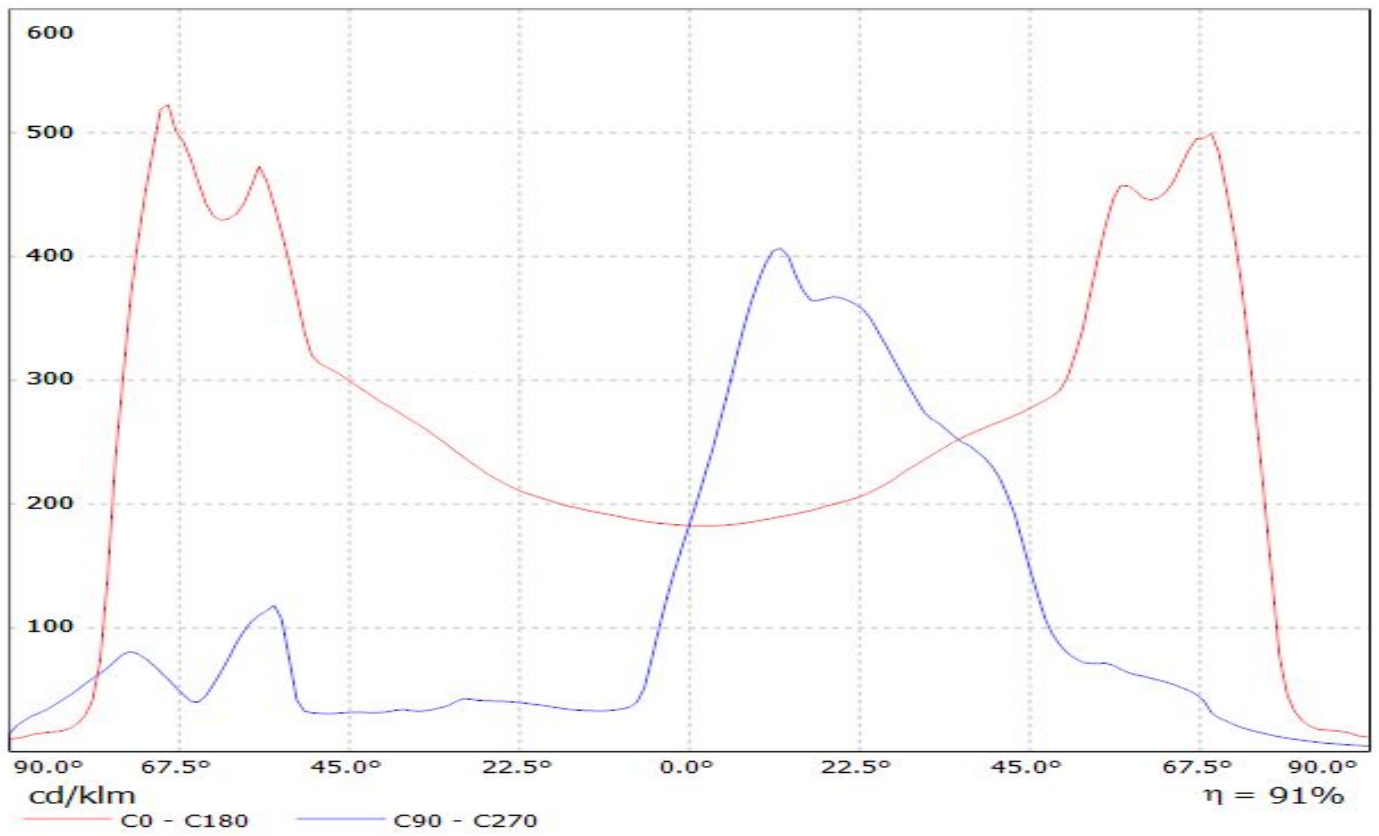

# LEDiL Oy C13300\_STRADA-2X2-T2\_(XM-L2) Eff.94.5% / LDC (Linear)

Luminaire: LEDiL Oy C13300\_STRADA-2X2-T2\_(XM-L2) Eff.94.5%

Lamps: 1 x XM-L2 (366lm@250mA)

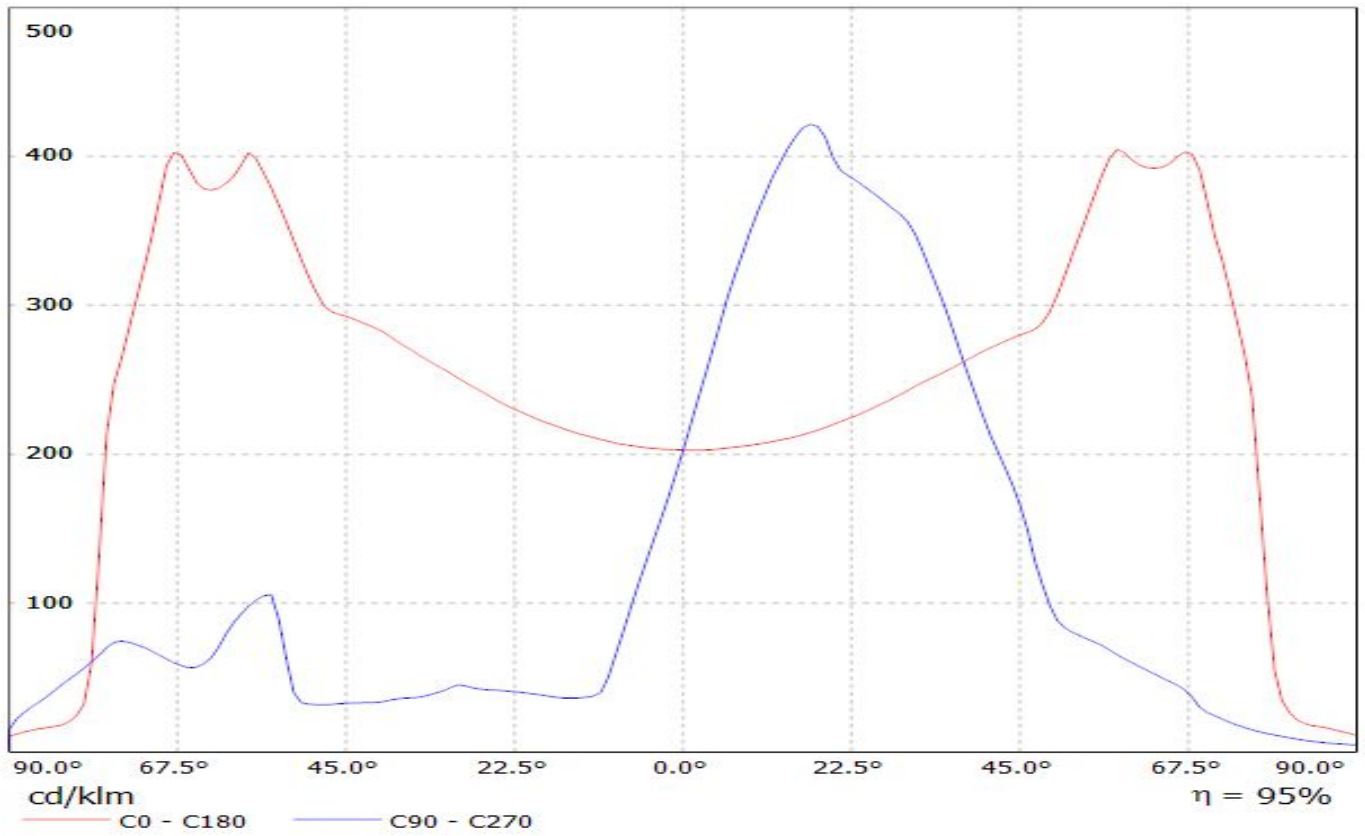



Luminaire: LEDiL Oy C13300\_STRADA-2x2-T2\_(XP-L)

Lamps: 1 x CREE\_XP-L\_2x2\_(XPLAWT-0-1B0-V40-00-0001)\_508.75lm@250mA\_CCT=7600K\_P=2.79963W\_I=249.9mA

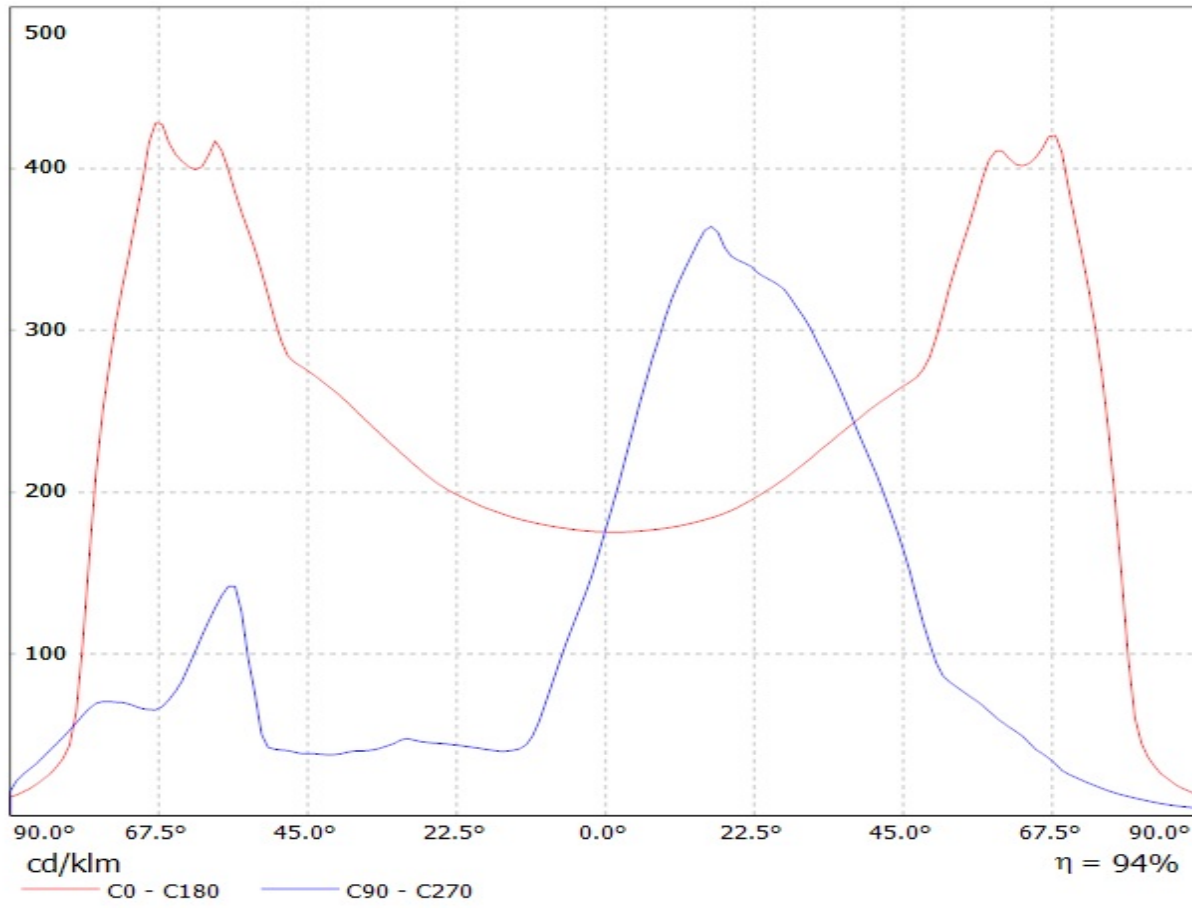

Luminaire: LEDiL Oy C13300\_STRADA-2X2-T2\_(XP-L\_HI)  
Lamps: 1 x Cree\_XP-L\_HI\_(2x2)\_(XPLAWT-H-5A3-U60-013-0001)  
\_455.077lm@250mA\_P=2.84011W\_I=0,2499A

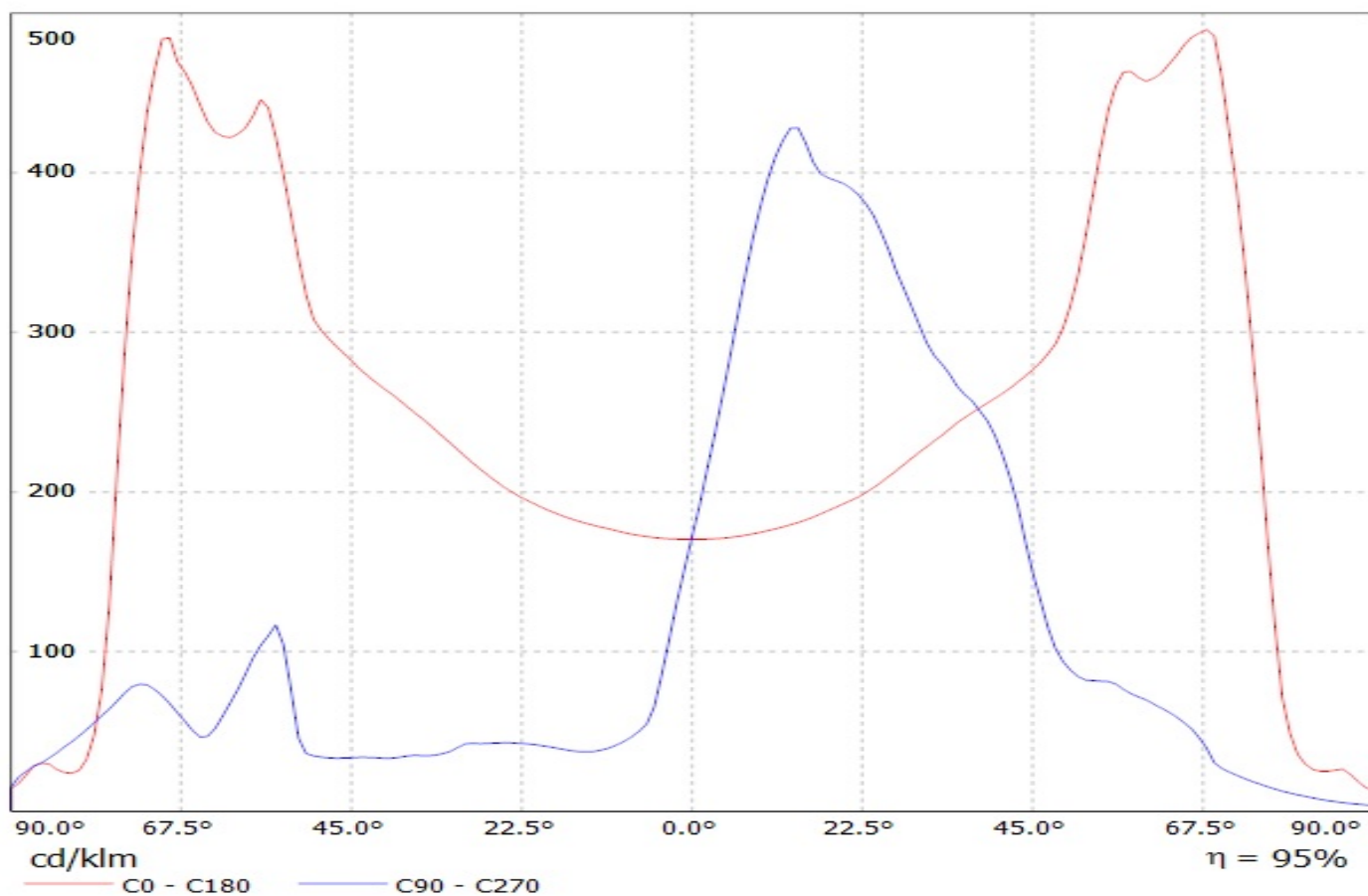

Luminaire: Ledil C13300\_STRADA-2X2-T2 (XP-L2)

Lamps: 1 x Cree\_XP-L2\_2x2\_(XPLBWT-00-0000-000BV50E3)550.93lm@250mA\_P=2.7815W\_I=0.25A

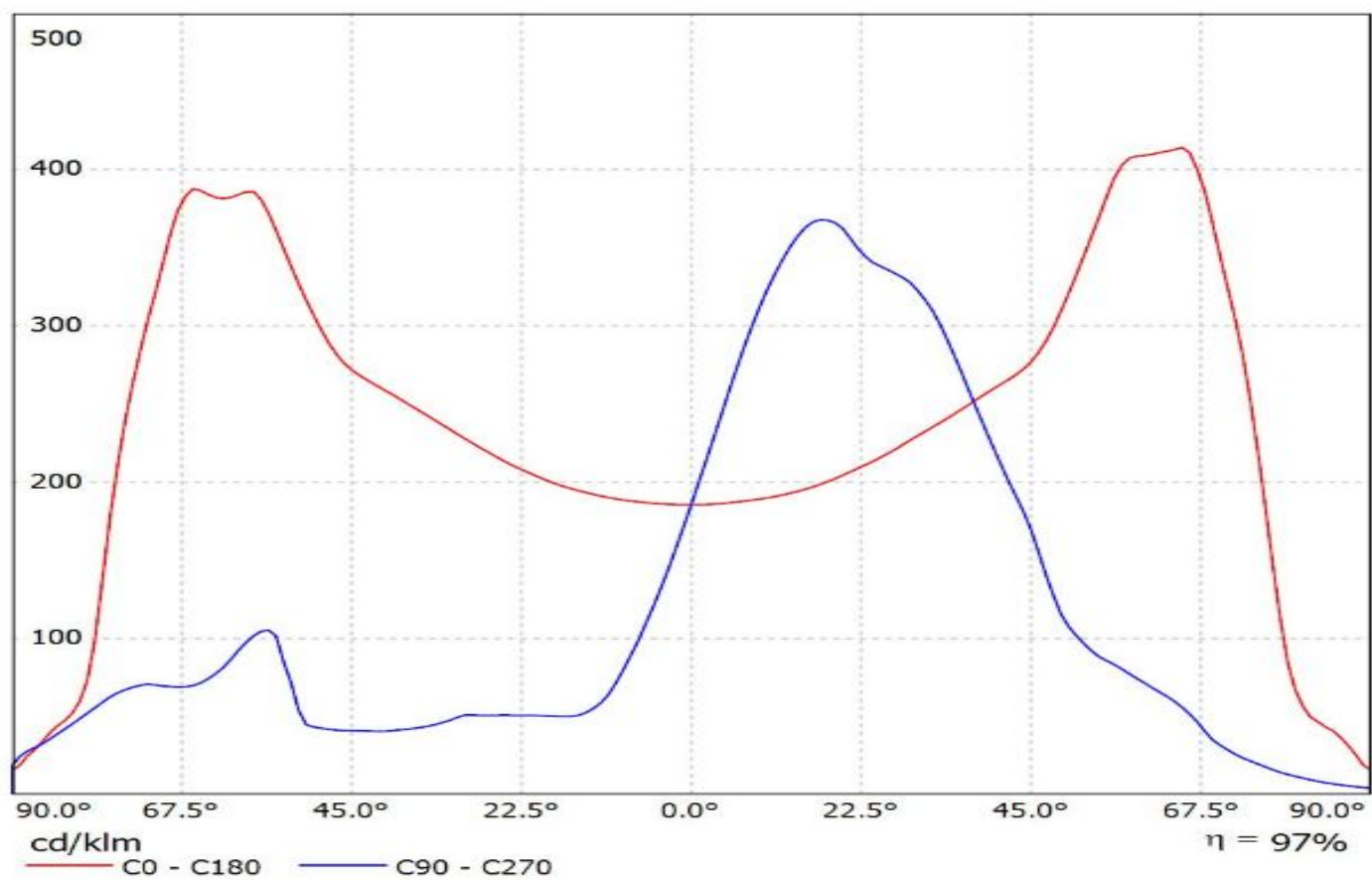

# LEDiL Oy C13300\_STRADA-2X2-T2\_(LG\_3535) Eff.94.2% / LDC (Linear)

Luminaire: LEDiL Oy C13300\_STRADA-2X2-T2\_(LG\_3535) Eff.94.2%

Lamps: 1 x LG\_3535\_Ceramic\_2x2 (374lm@250mA)

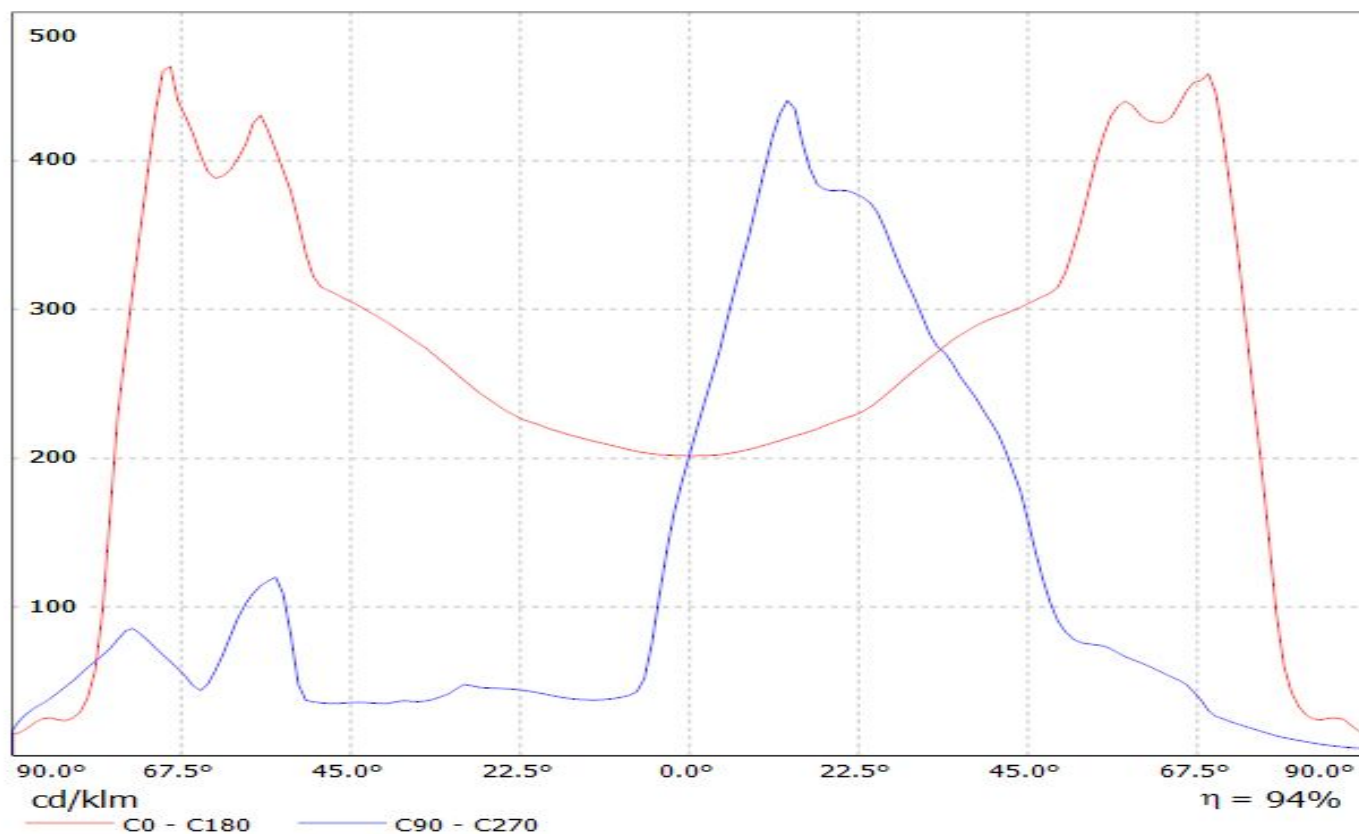

**LEDiL Oy C13300\_STRADA-2X2-T2\_(LG-3535-CERAMIC-GEN2) Eff.94.0% / LDC  
(Linear)**

Luminaire: LEDiL Oy C13300\_STRADA-2X2-T2\_(LG-3535-CERAMIC-GEN2) Eff.94.0%

Lamps: 1 x LG-3535-CERAMIC-GEN2\_2x2\_472.9lm@250mA\_P=2.8651W\_CCT=6562K\_I=249.9mA

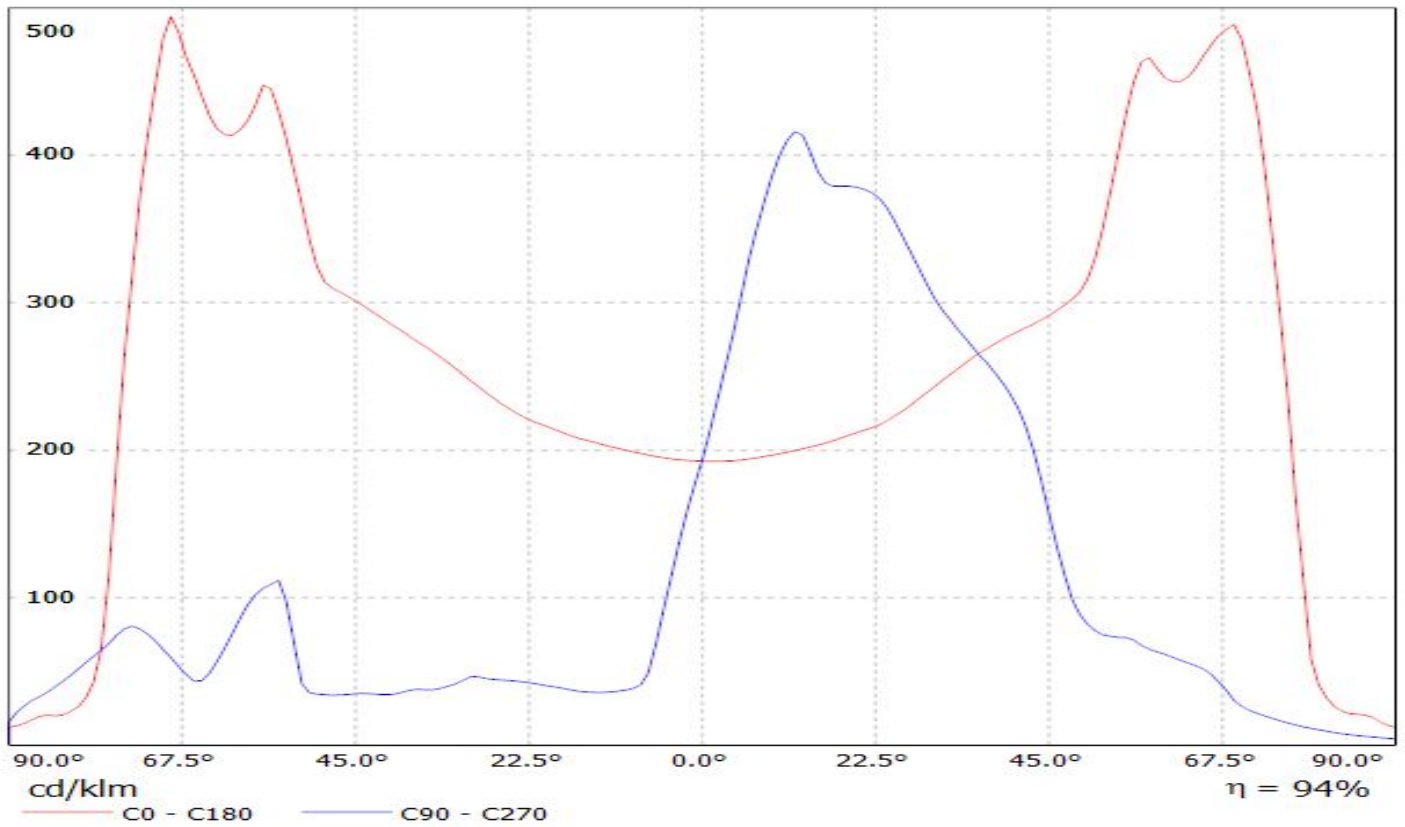

# LEDiL Oy C13300\_STRADA-2X2-T2\_(LUXEON\_R) Eff.95.8% / LDC (Linear)

Luminaire: LEDiL Oy C13300\_STRADA-2X2-T2\_(LUXEON\_R) Eff.95.8%

Lamps: 1 x LUXEON\_R (303lm@250mA)

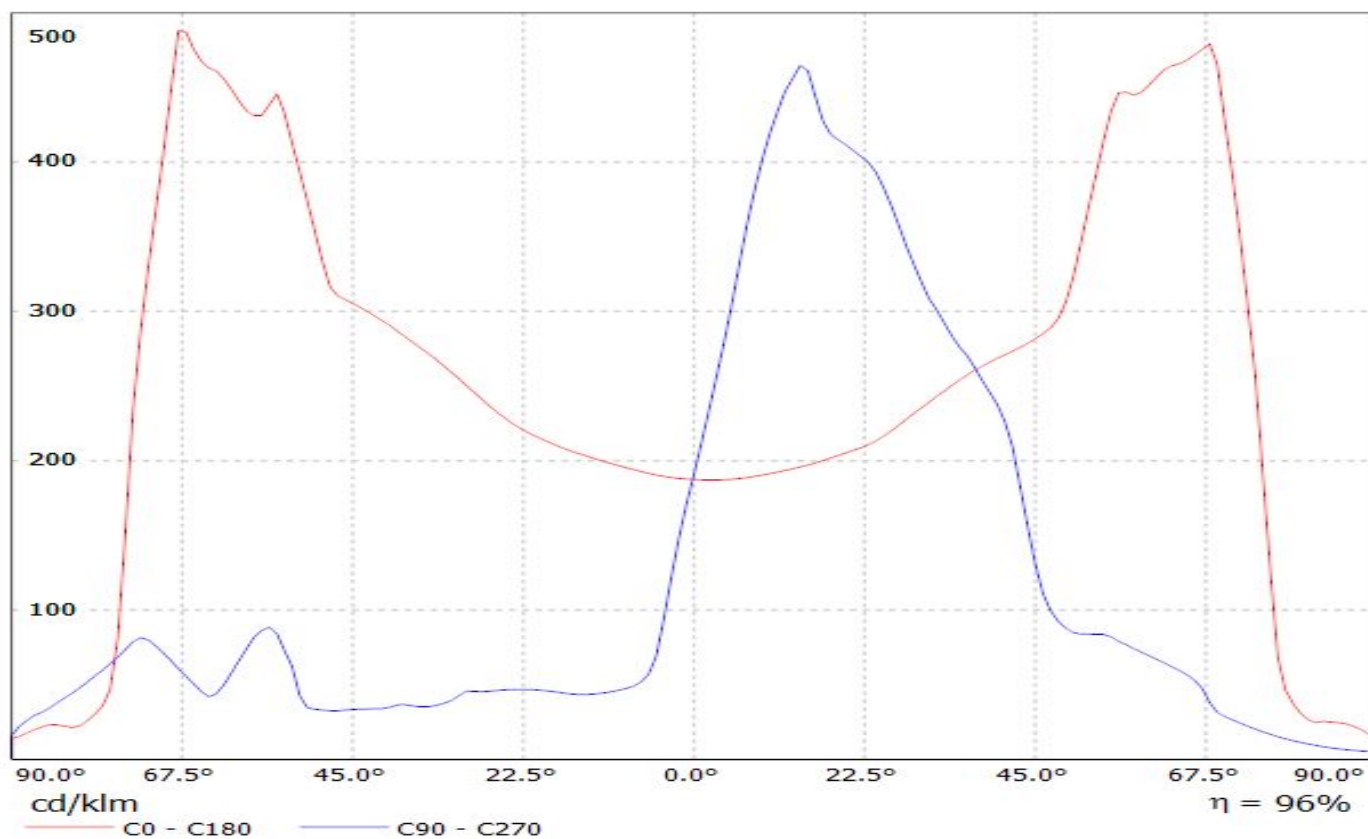

# LEDiL Oy C13300\_STRADA-2X2-T2\_(REBEL\_ES) Eff.94.5% / LDC (Linear)

Luminaire: LEDiL Oy C13300\_STRADA-2X2-T2\_(REBEL\_ES) Eff.94.5%  
Lamps: 1 x XM-L (338lm@250mA)

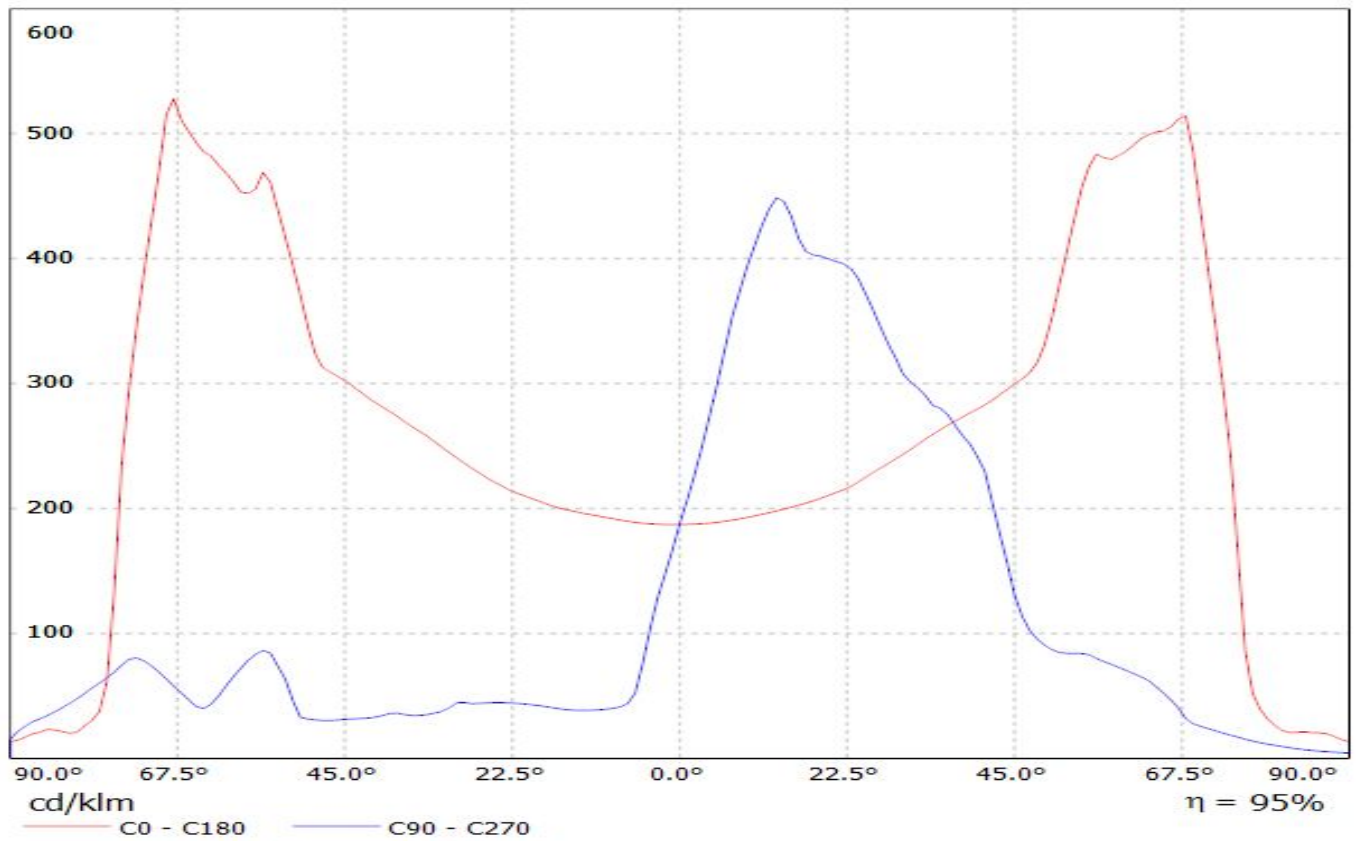

Luminaire: LEDiL Oy C13300\_STRADA-2x2-T2\_(LUXEON\_T) Eff.94.1%  
Lamps: 1 x LUXEON\_T 2x2 (294lm@250mA)

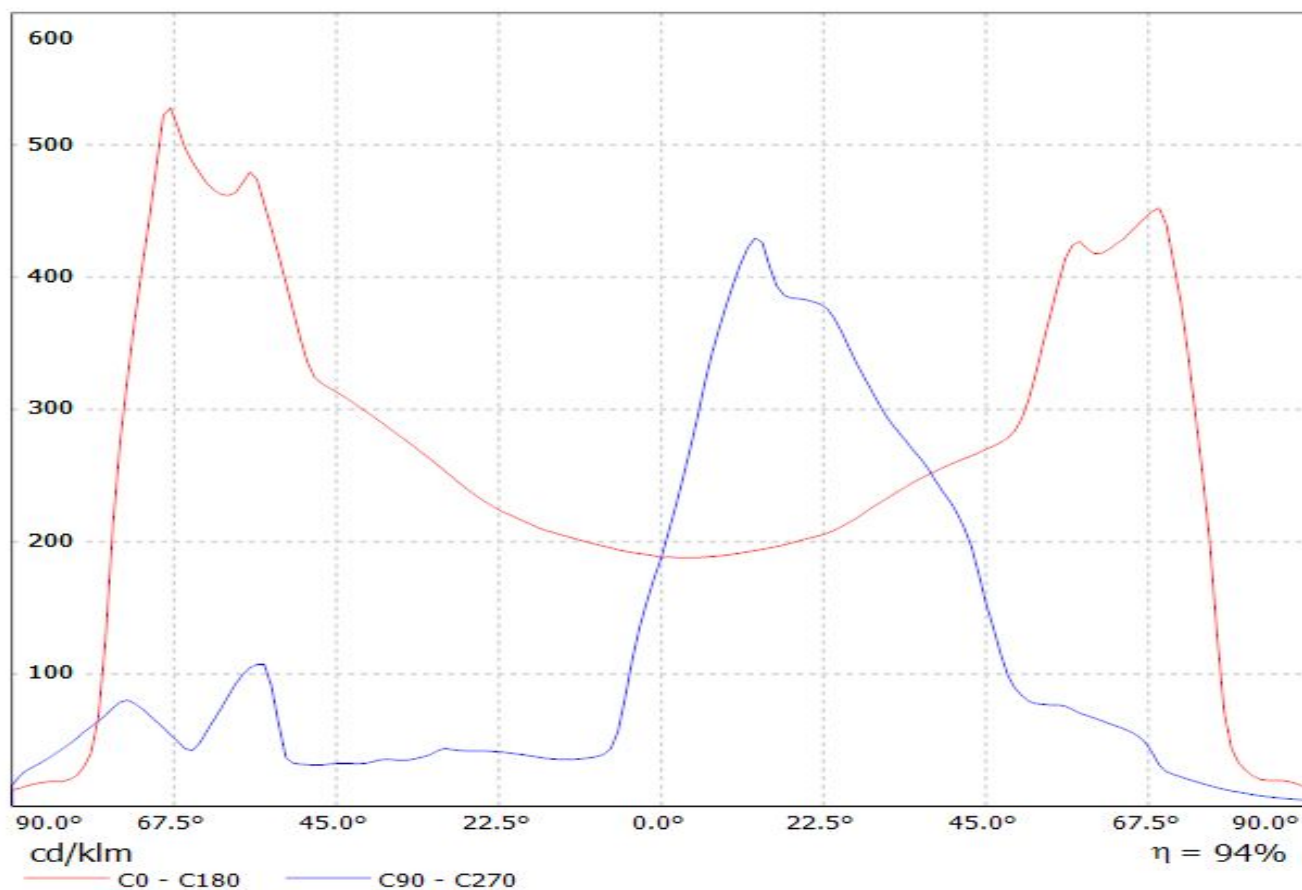



Luminaire: LEDiL Oy C13300\_STRADA-2X2-T2\_(Luxeon-Z-ES) Eff: 94%  
Lamps: 1 x Luxeon Z ES 2x2 (LXZ2-3090) 209.277lm@250mA\_P=2.81W\_I=0.2499A

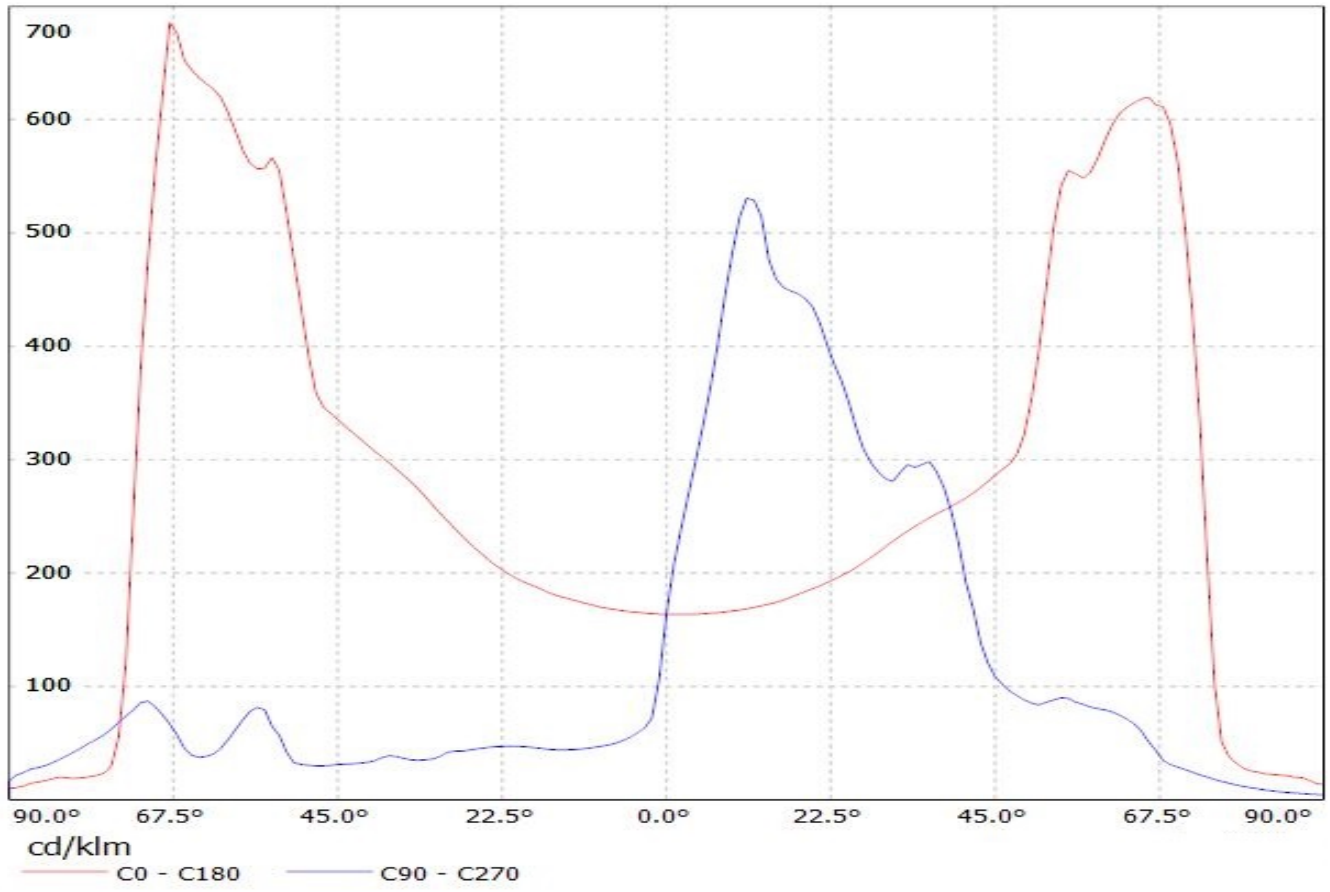

Luminaire: LEDiL Oy C13300\_STRADA-2X2-T2\_(LUXEON\_Q)

Lamps: 1 x LUXEON\_Q\_2x2\_(LHQ-3080)\_298.363lm@250mA\_P=2.87385W\_I=249.9mA

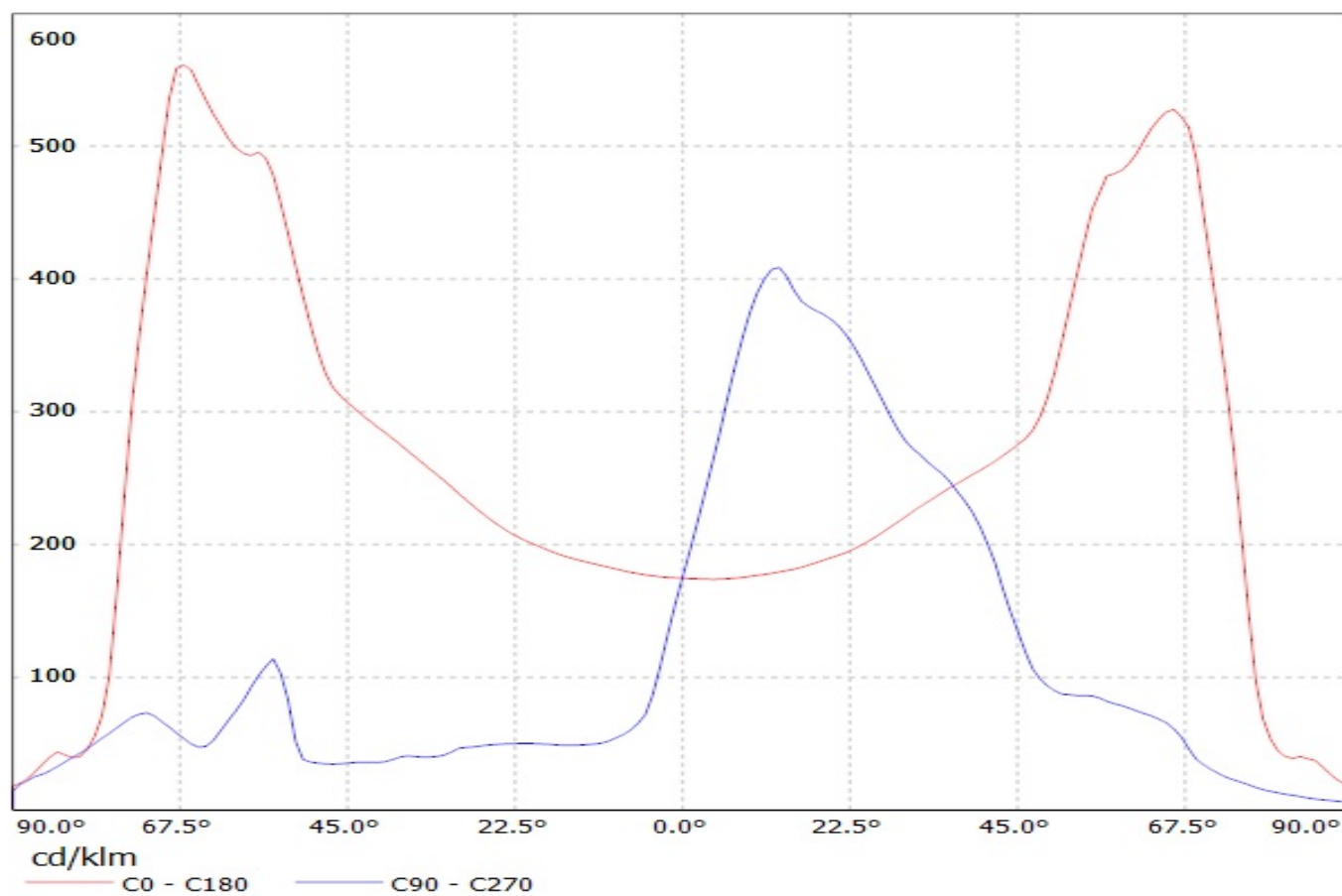

Luminaire: LEDiL Oy C13300\_STRADA-2X2-T2\_(LUXEON\_MZ) Eff.94.0%

Lamps: 1 x LUXEON\_MZ\_2x2\_(LMZ7-QW57)\_417.25lm@250mA\_P=2.71916W\_CCT=5700K\_I=249.9mA

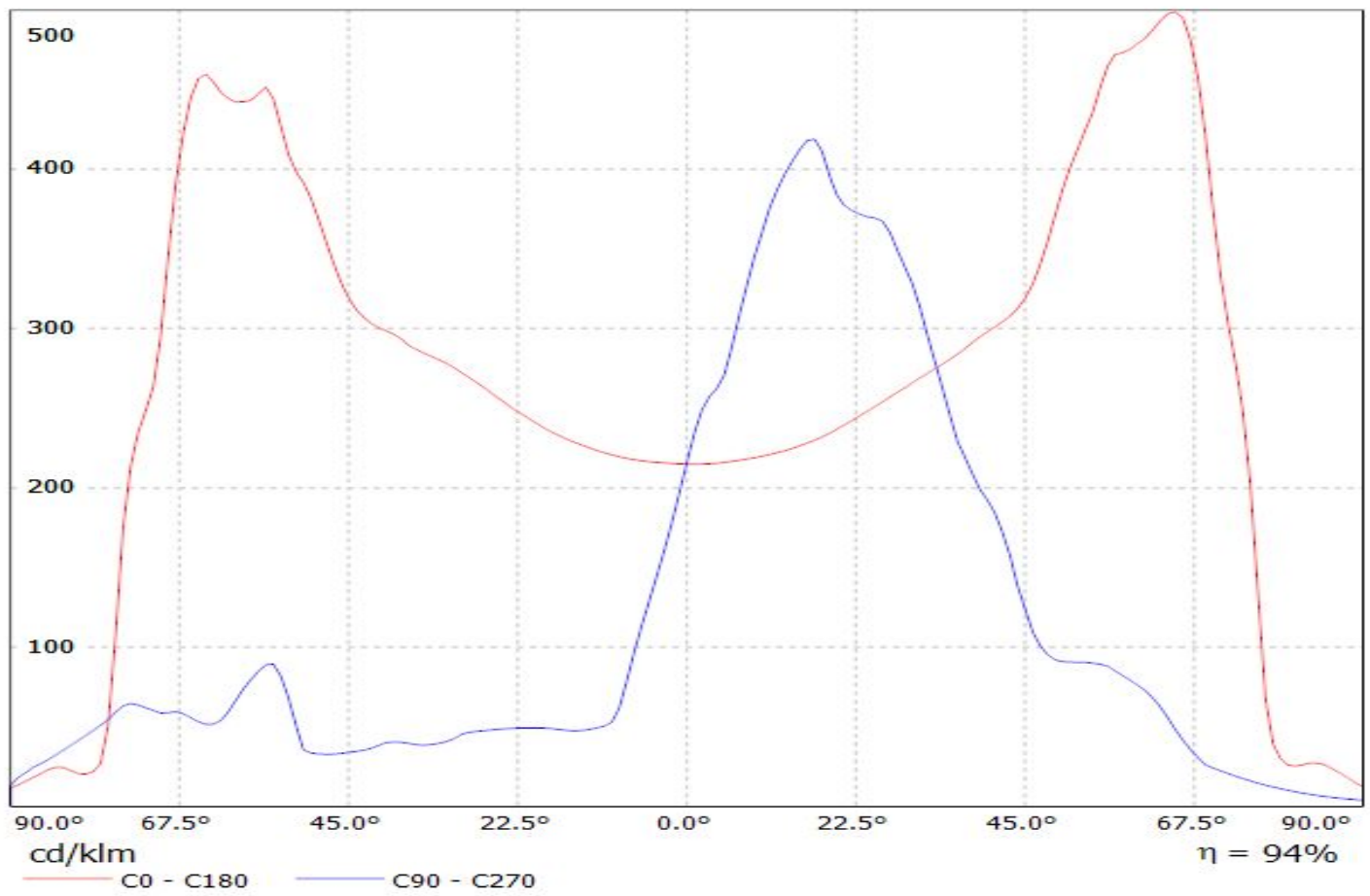

Luminaire: LEDiL Oy C13300\_STRADA-2X2-T2\_(Luxeon\_TX)  
Lamps: 1 x Luxeon\_TX\_2x2\_321.384lm@250mA\_P=2.79488W\_I=249.9mA

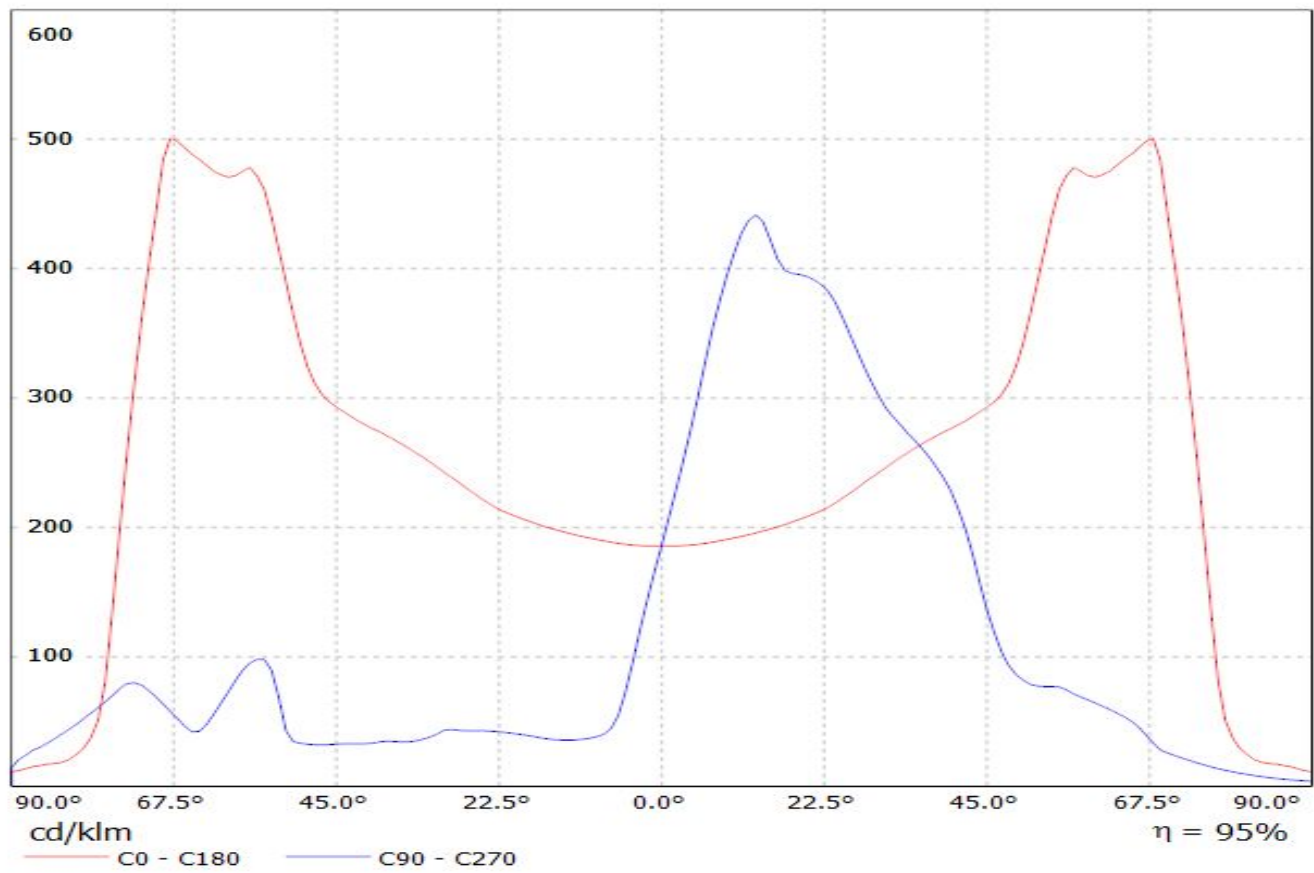

Luminaire: LEDiL Oy C13300\_STRADA-2X2-T2\_(Luxeon\_5050)

Lamps: 1 x Luxeon\_5050\_2x2\_1270.76lm@80mA\_CCT=5700K\_P=7.35815W\_I=0.080A\_70CRI

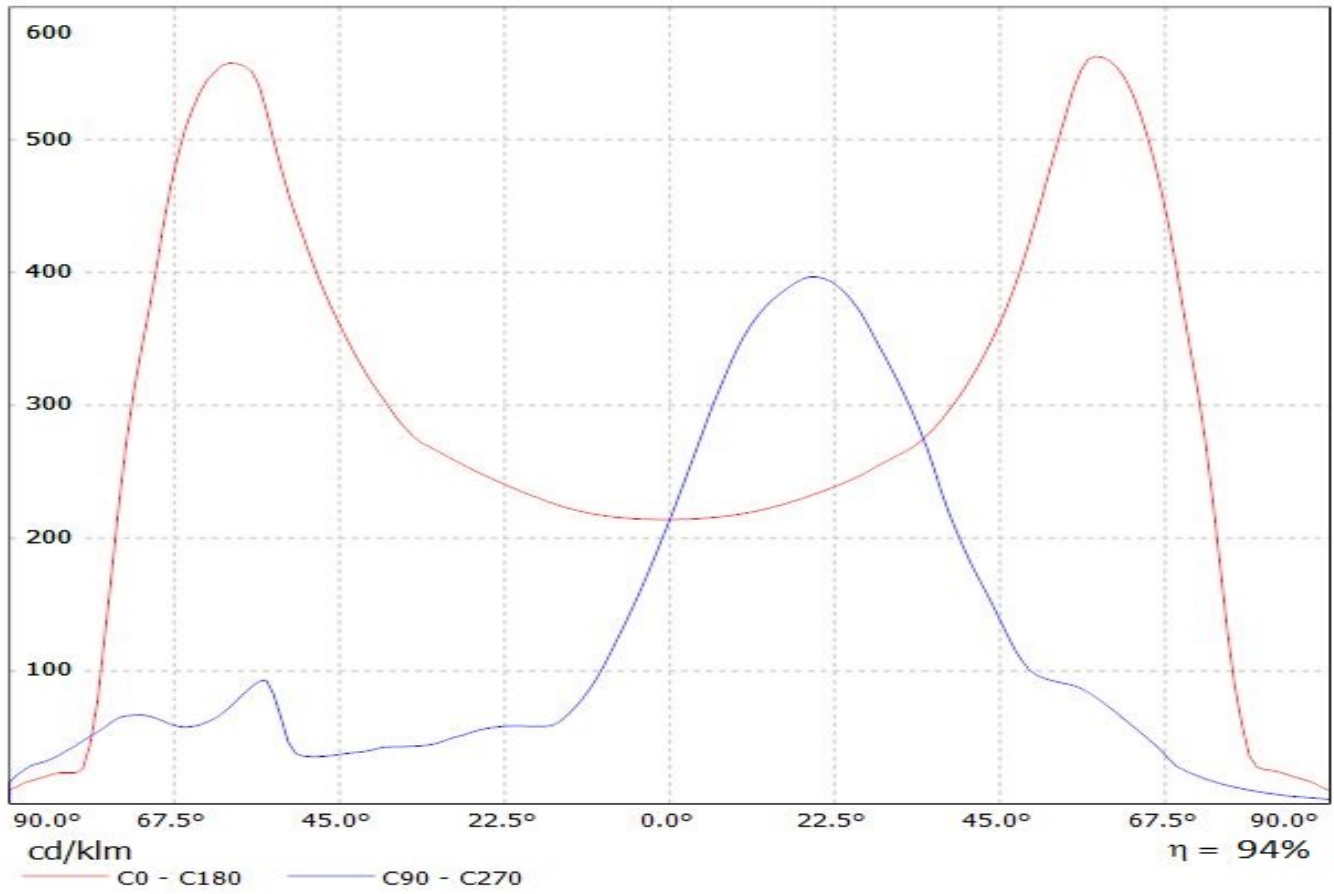

**LEDiL Oy C13300\_STRADA-2x2-T2\_(NICHIA\_NS9x383) Eff.95.4% / LDC  
(Linear)**

Luminaire: LEDiL Oy C13300\_STRADA-2x2-T2\_(NICHIA\_NS9x383) Eff.95.4%  
Lamps: 1 x NICHIA\_NS9x383 (287.074lm@250mA)

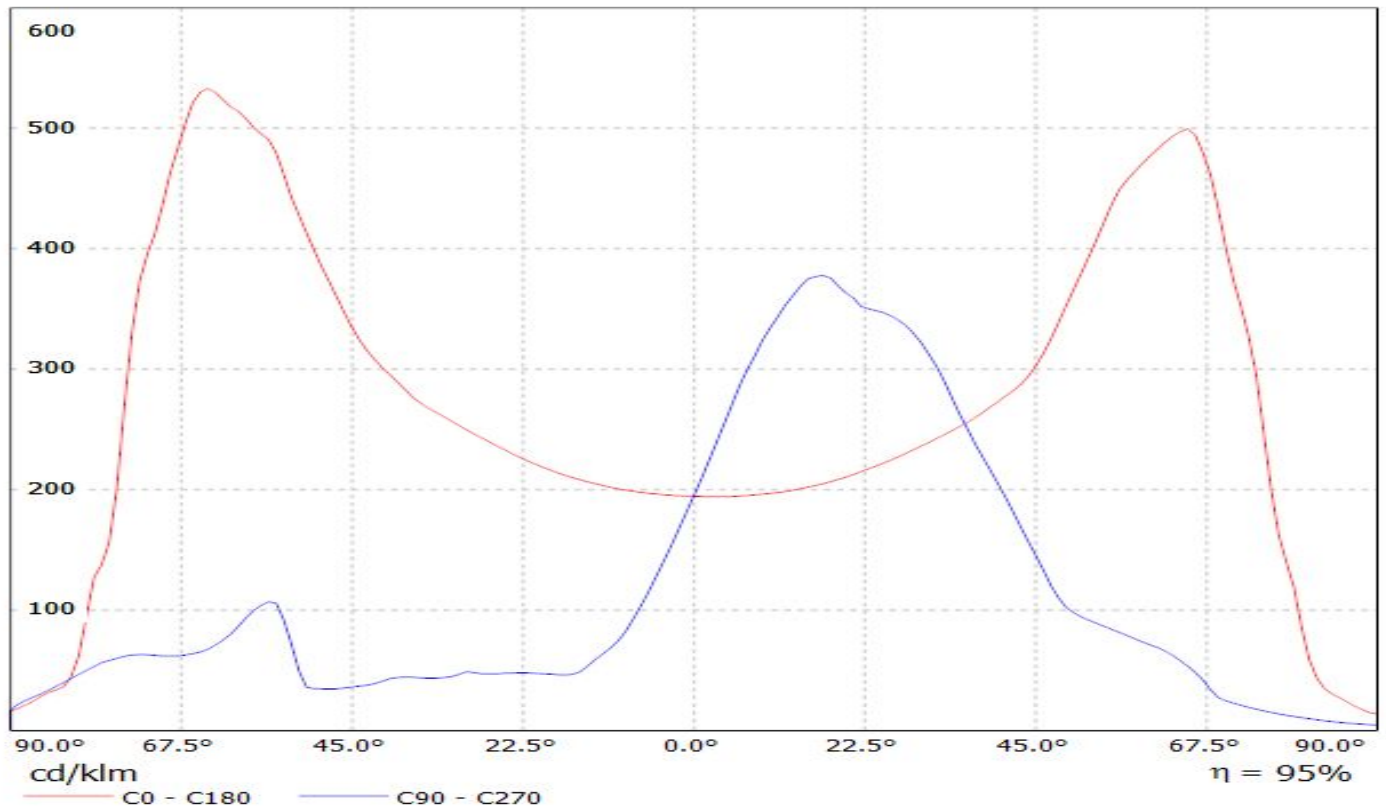

Luminaire: LEDiL Oy C13300\_STRADA-2X2-T2\_(NWSL229AE)

Lamps: 1 x Nichia\_2X2\_NWSL229AE\_476.548lm@250mA\_P=2.7515W\_I=0.250A

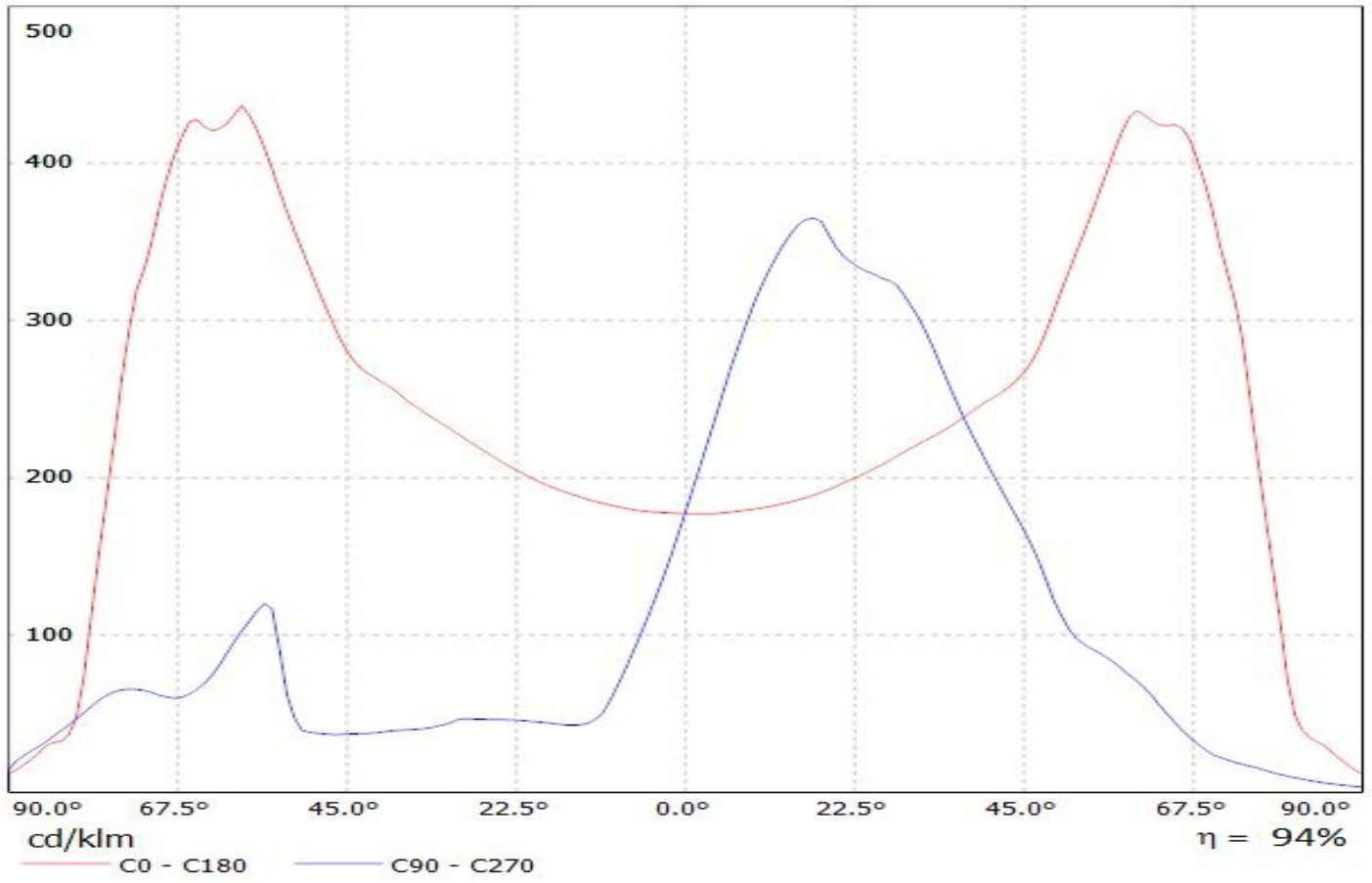

Luminaire: Ledil C13300\_STRADA-2X2-T2 (NVSW319AE)  
Lamps: 1 x Nichia\_NVSW319AE\_(sm405D440f2L2R70)

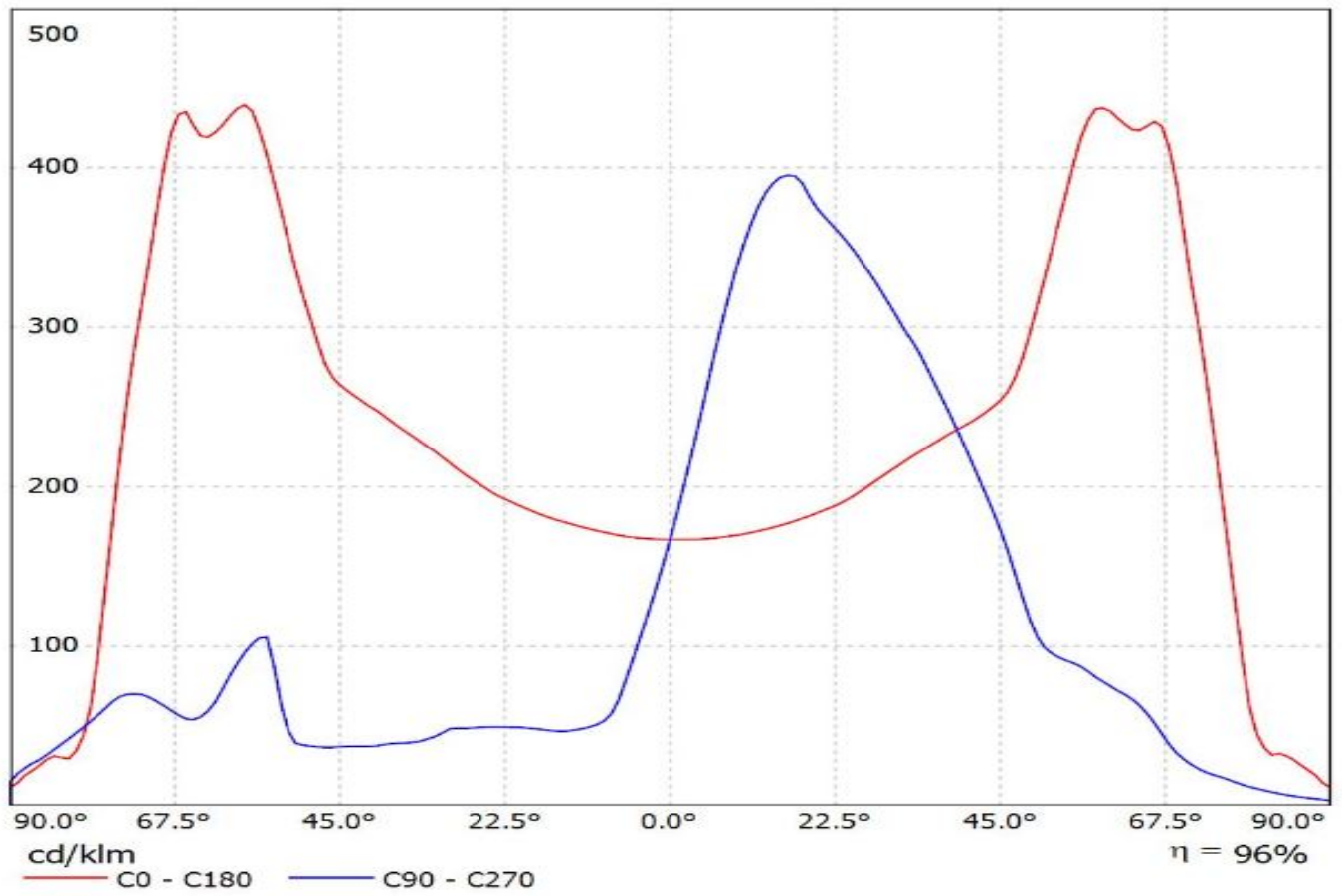



Luminaire: LEDiL Oy C13300\_STRADA-2X2-T2\_(E21A)  
Lamps: 1 x Nichia\_E21A\_452.248lm@250mA\_2.805W\_I=0.250A

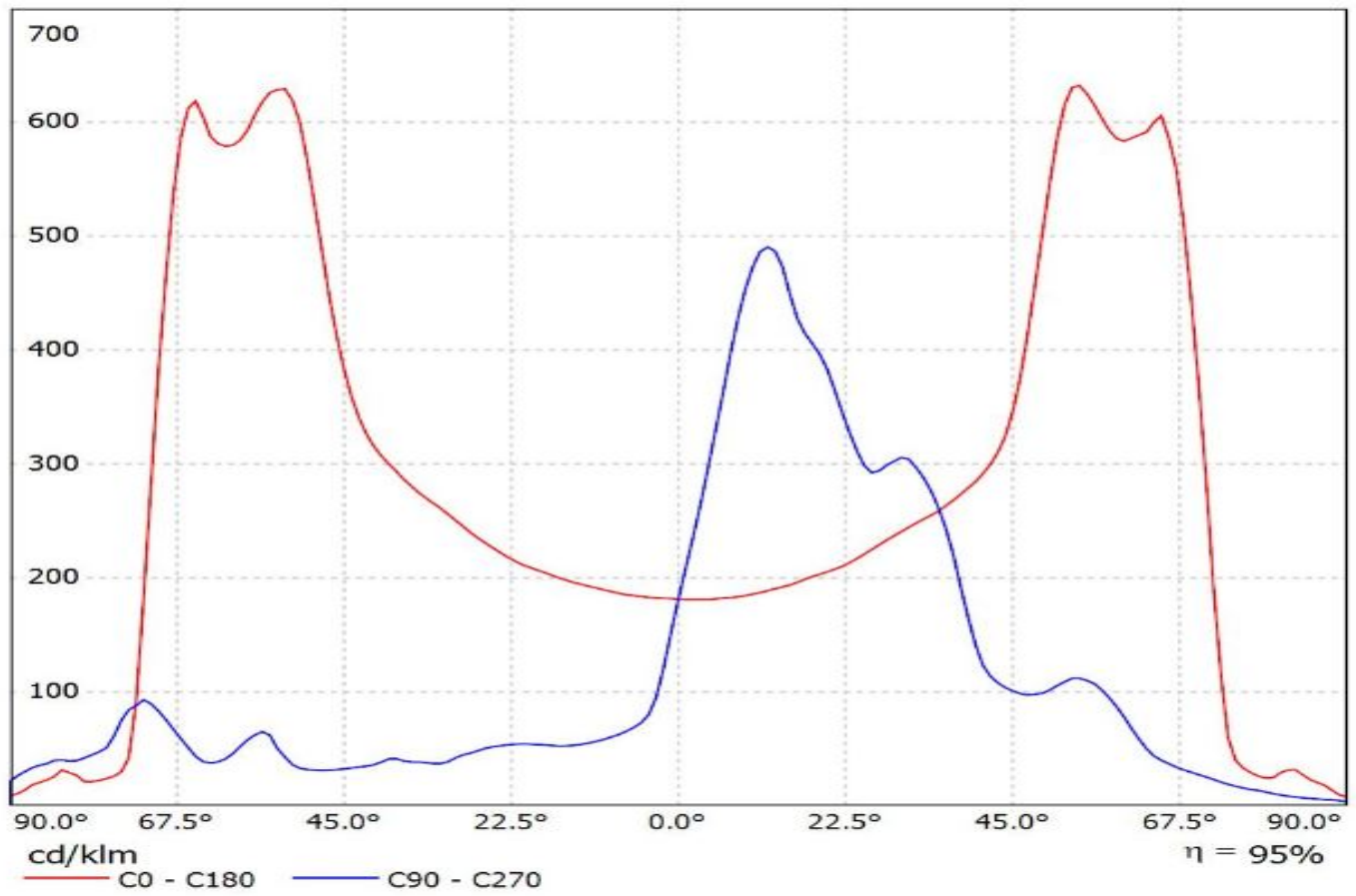

Luminaire: LEDiL Oy C13300\_STRADA-2X2-T2 Eff.94.4%  
Lamps: 1 x Osram Square PC (399lm@250mA)

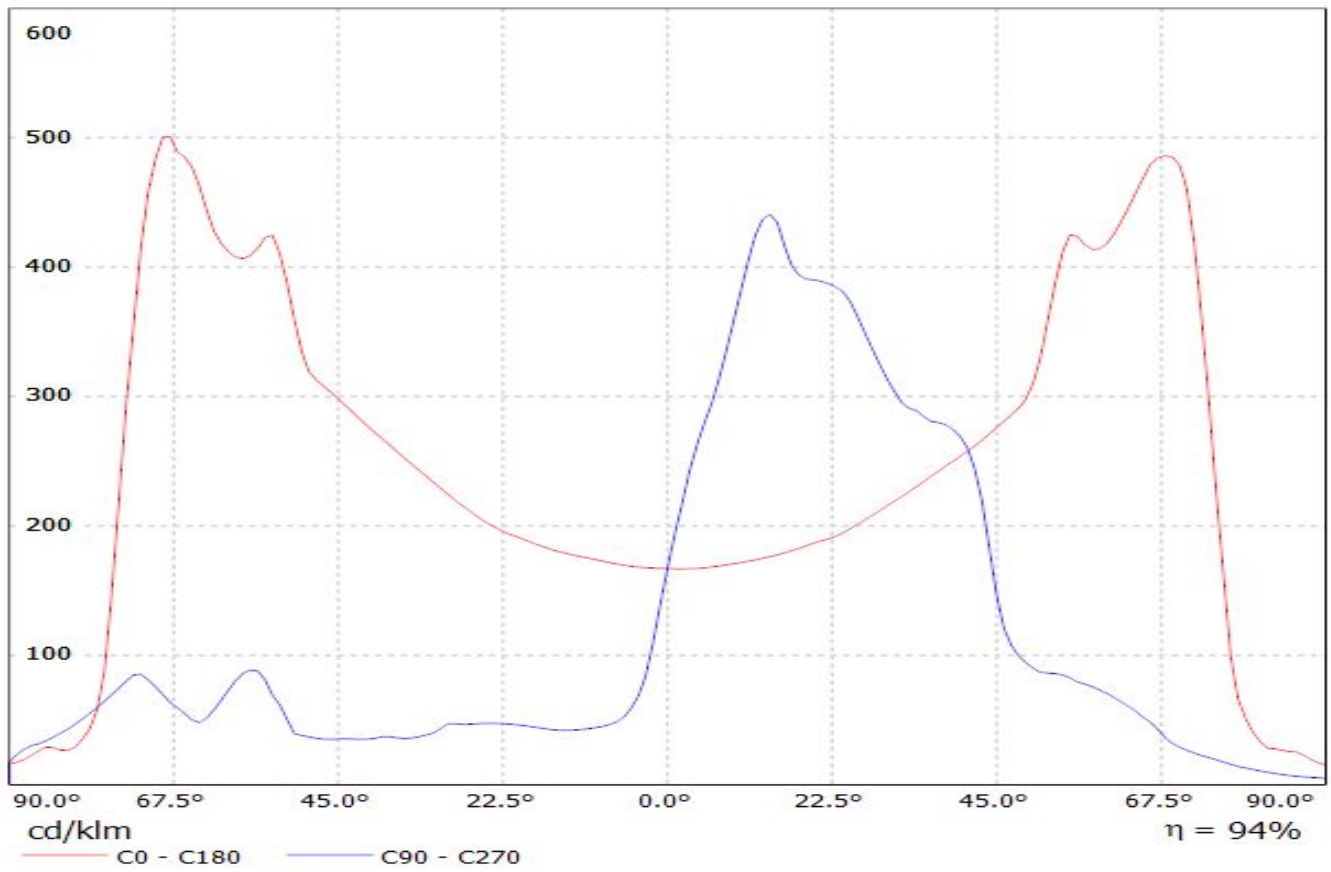

**Ledil C13300\_STRADA-2x2-T2\_(square\_gen3) / LDC (Linear)**

Luminaire: Ledil C13300\_STRADA-2x2-T2\_(square\_gen3)

Lamps: 1 x Oslon\_square\_gen3\_2x2\_(GW\_CSSRM2.PM)\_460.271lm@250mA\_CCT=5000K\_P=2.80625W\_I=0.25A

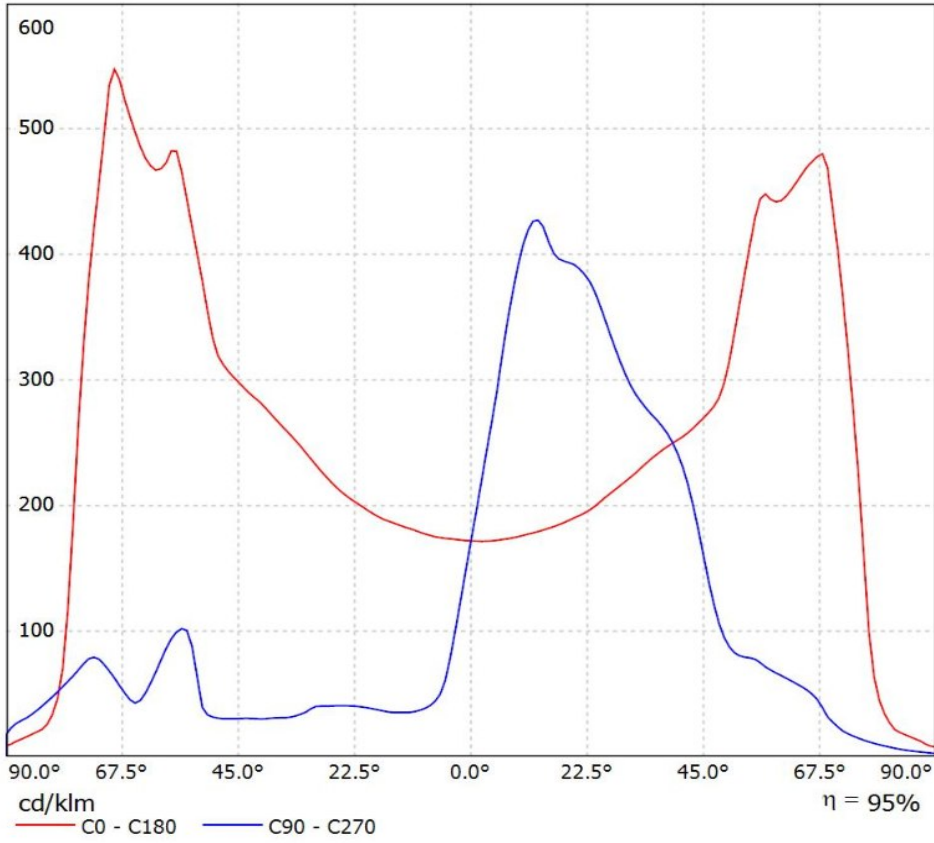

Luminaire: Ledil Oy C13300\_STRADA-2X2-T2\_(Duris\_P8)\_SIMULATED  
Lamps: 1 x Osram Duris P8

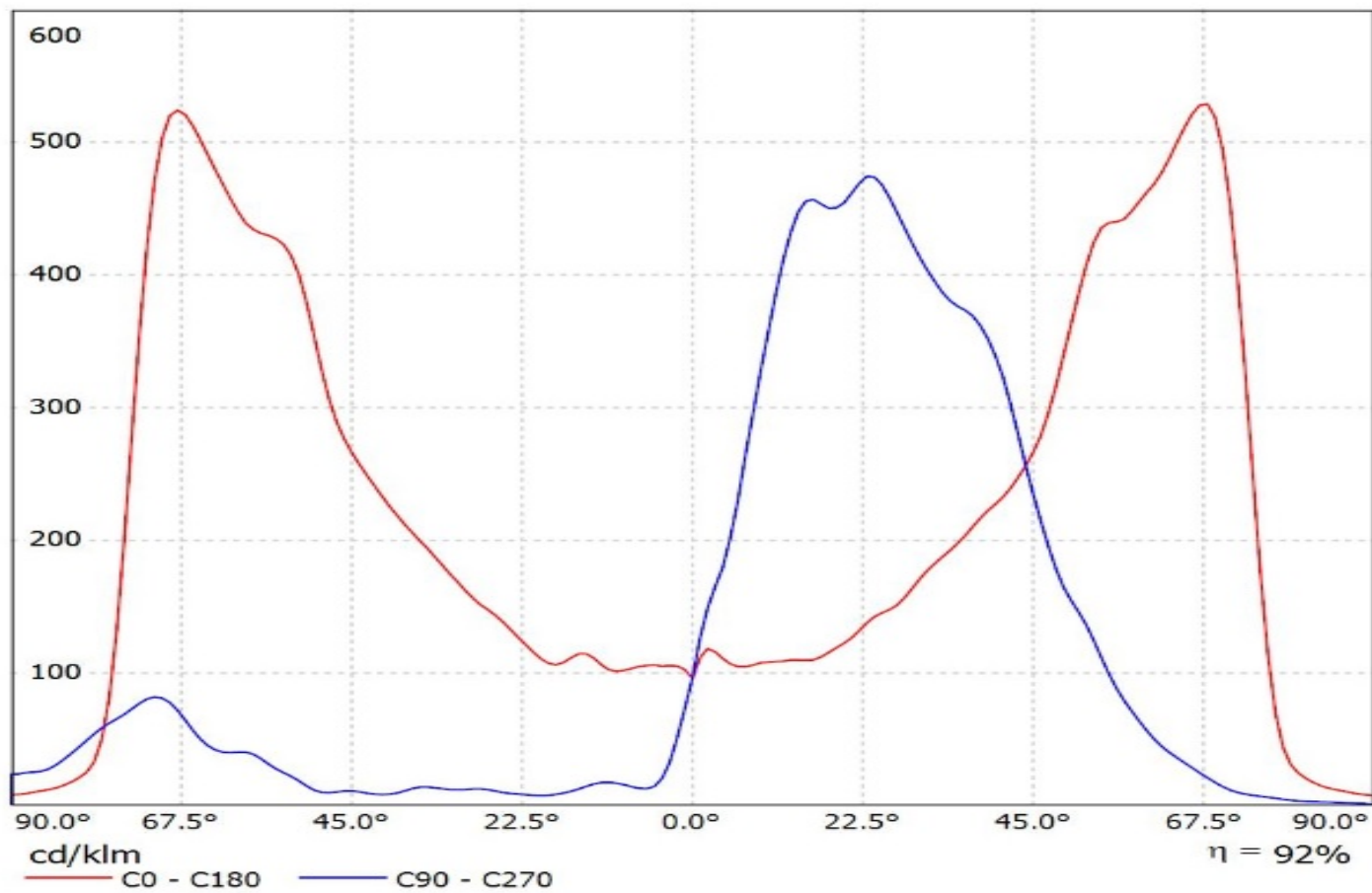

Luminaire: LEDiL Oy C13300\_STRADA-2X2-T2\_(Fortimo\_F-Flex\_2x8\_740DAG3)

Lamps: 1 x Philips\_Fortimo\_F-Flex\_2x8\_740DAG3\_1786.86lm@250mA\_P=11.6092W\_I=0.2498A

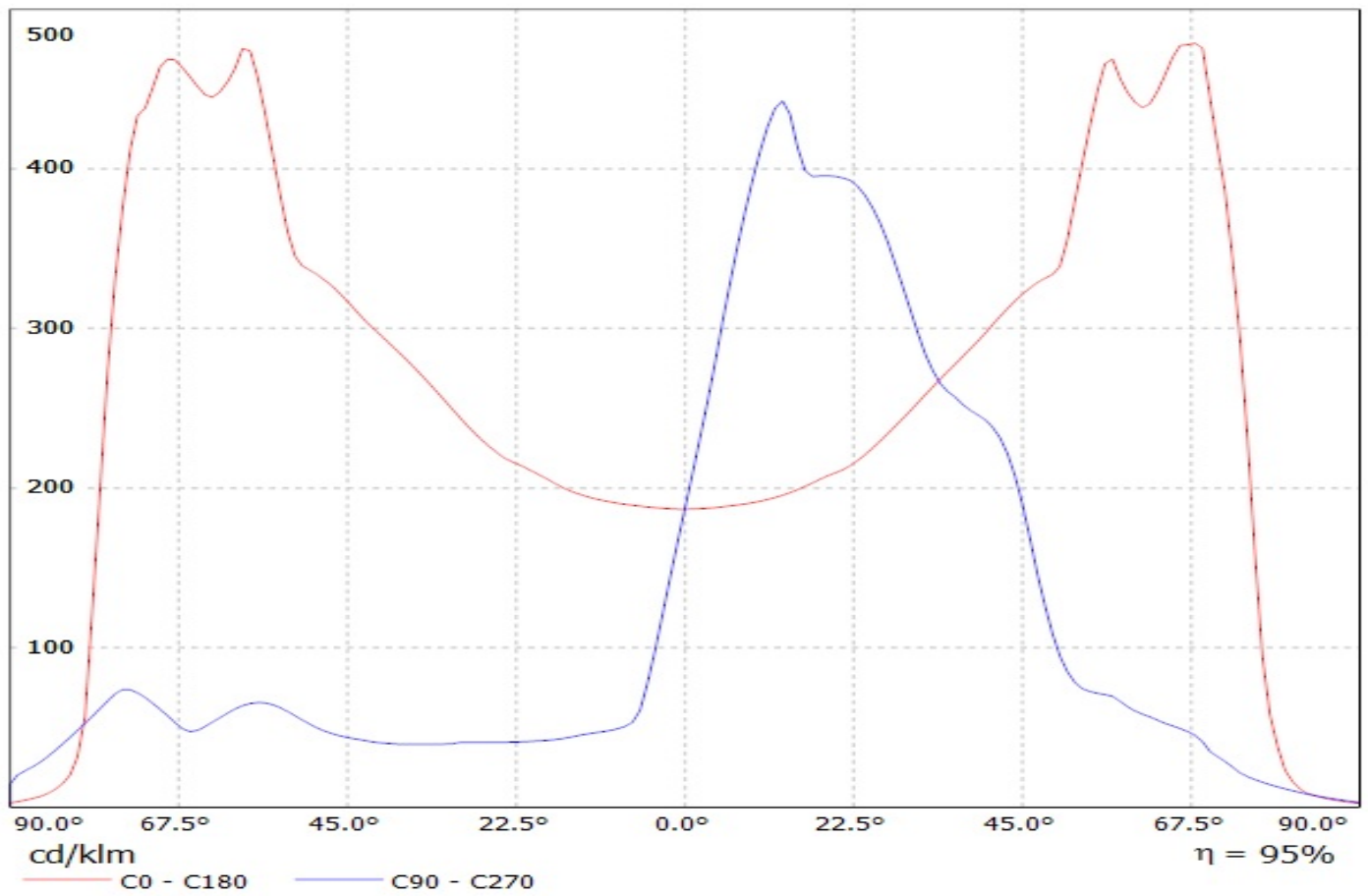

Luminaire: LEDiL Oy C13300\_STRADA-2X2-T2\_(LH351B)

Lamps: 1 x SAMSUNG\_LH351B\_2x2\_440.73lm@250mA\_P=2.84311W\_I=249.9mA

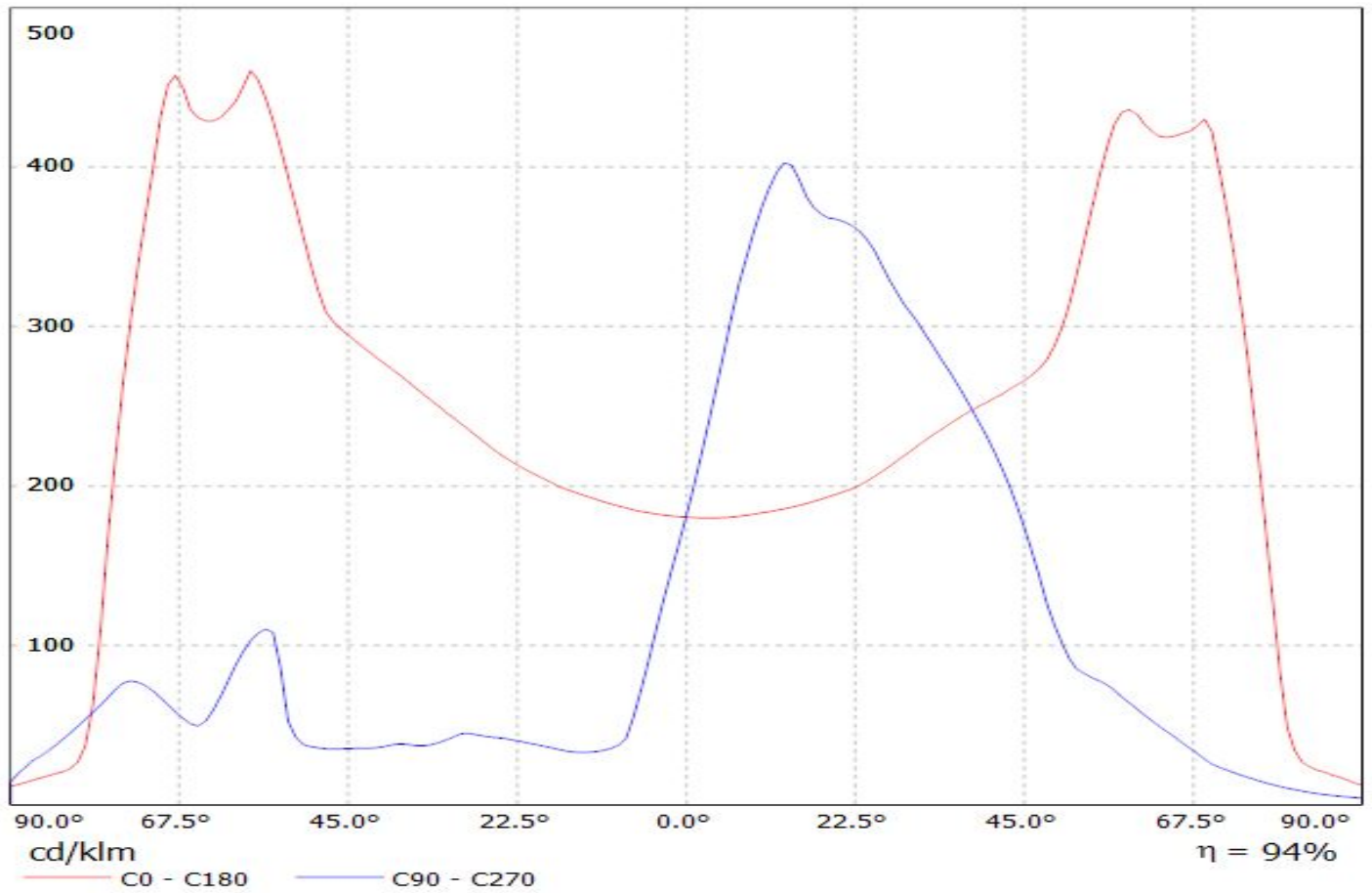

Luminaire: LEDiL Oy C13300\_STRADA-2X2-T2\_(LH351Z)  
Lamps: 1 x SAMSUNG\_LH351Z\_2x2\_365.89lm@250mA\_P=2.86371W\_I=249.8mA

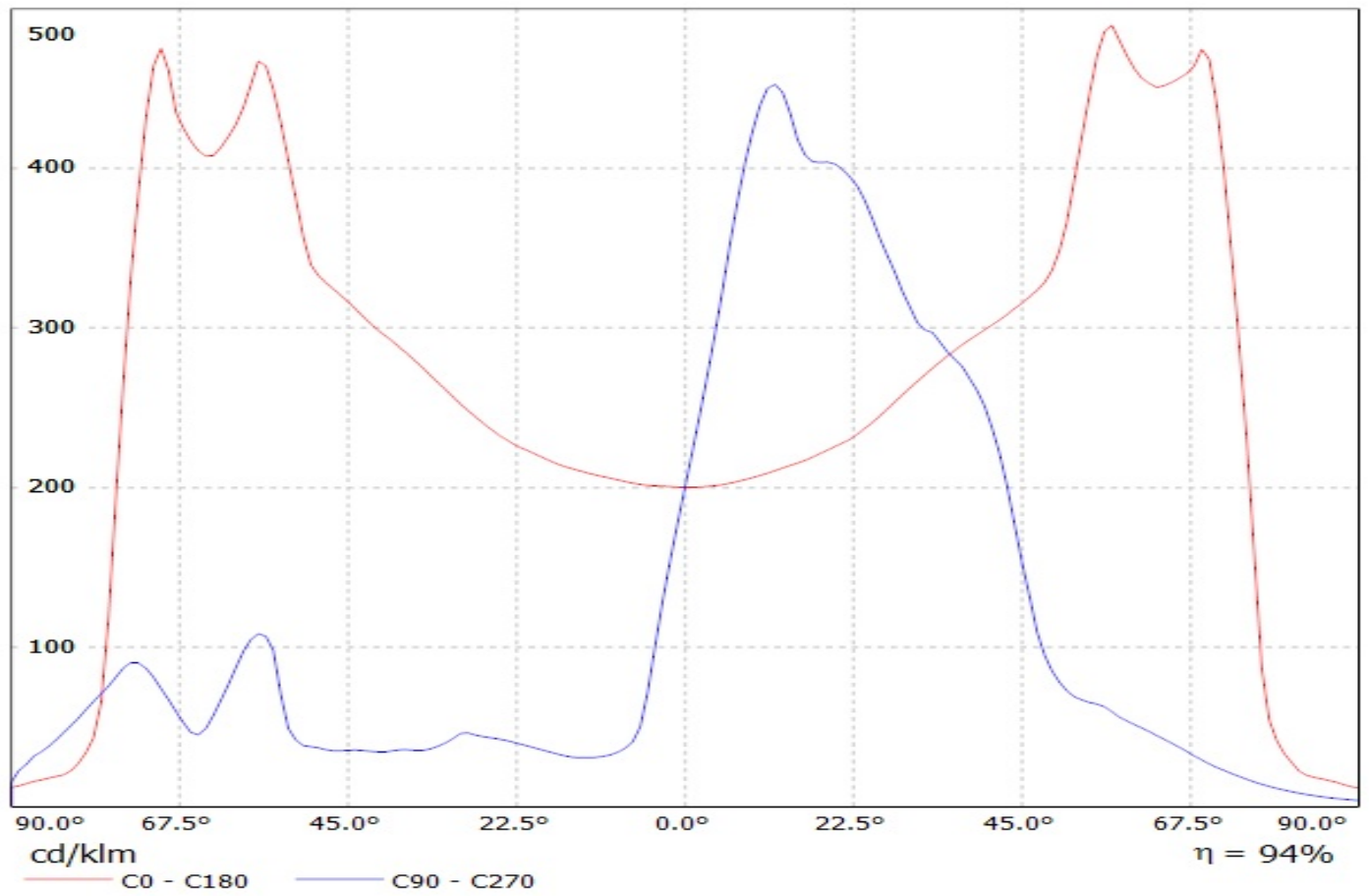

Luminaire: LEDiL Oy C13300\_STRADA-2X2-T2 (LH351D)  
Lamps: 1 x Samsung\_LH351D\_524.264lm@250mA\_P=2.7523W\_I=0.250A

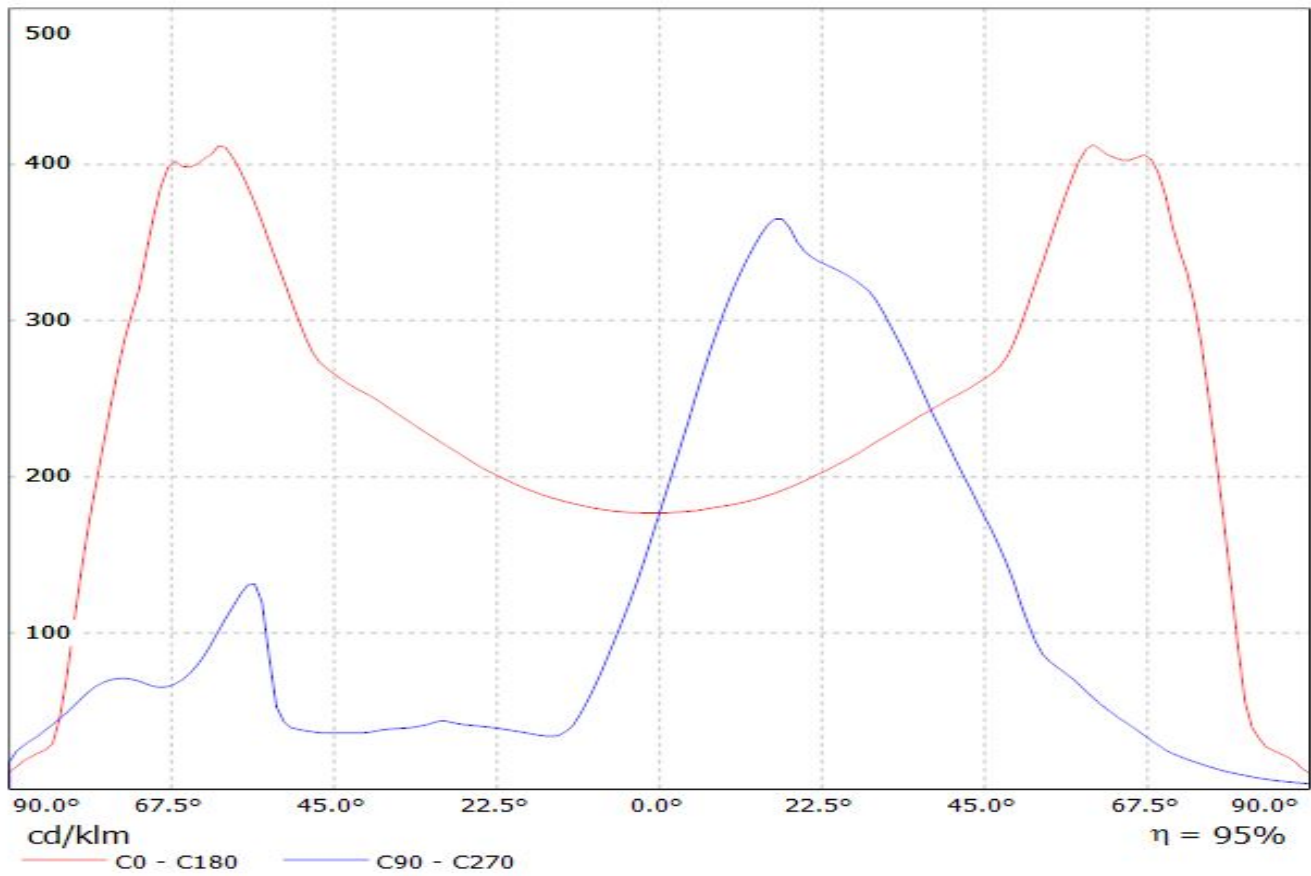



Luminaire: LEDiL Oy C13300\_STRADA-2x2-T2\_(MJT4040) Eff. 94%  
Lamps: 1 x SEOUL ACRICH MJT4040 (SAW09H0A) 255lm@40mA P=2.37W I=40mA

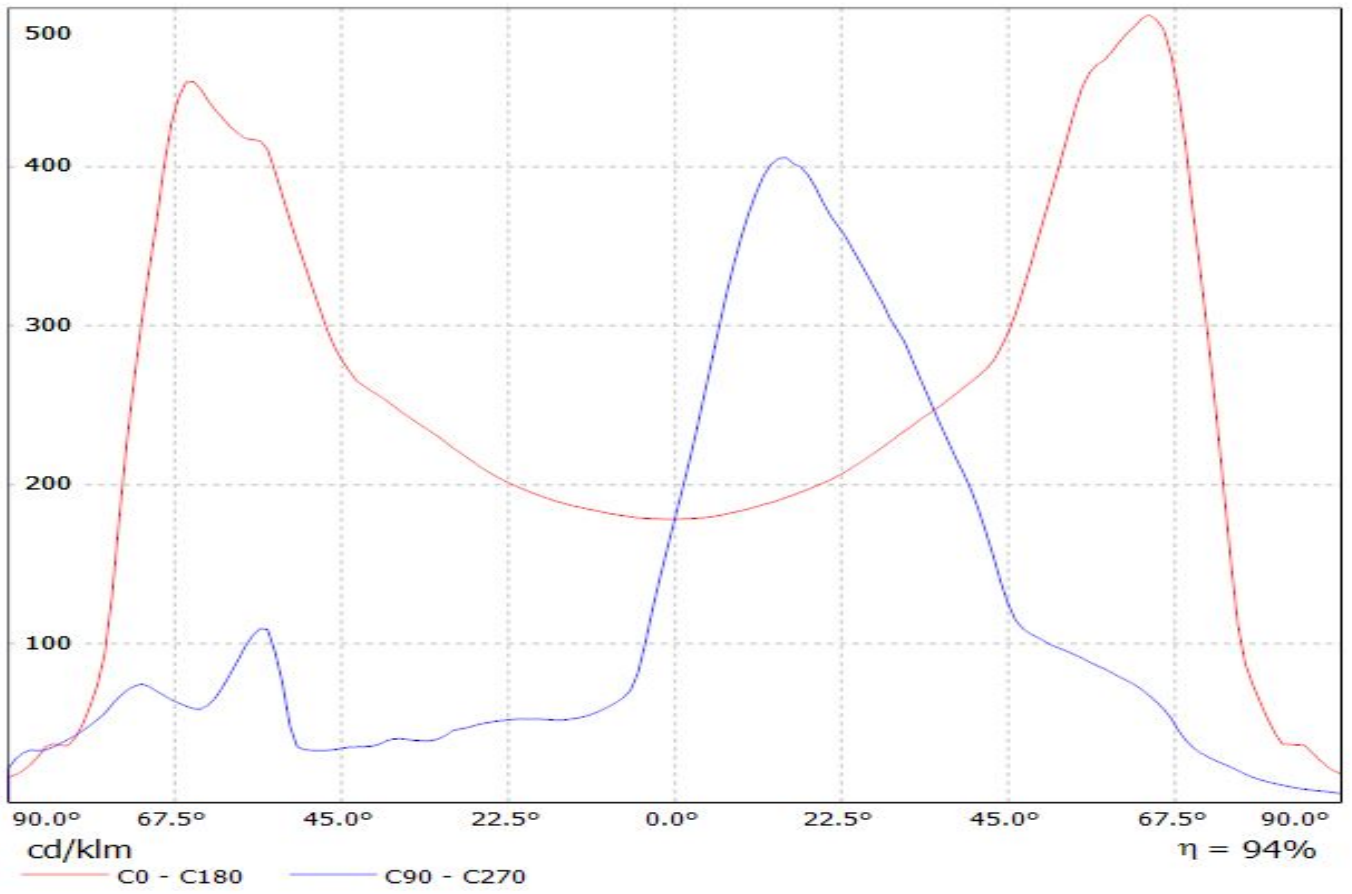

Luminaire: LEDil Oy C13300\_STRADA-2X2-T2\_(Z5M1) Efficiency=94%  
Lamps: 1 x Seoul Z5M1 (SZ5-M1-WN-C8) 379lm @ 250mA CCT=4600K P=2.9W I=250mA

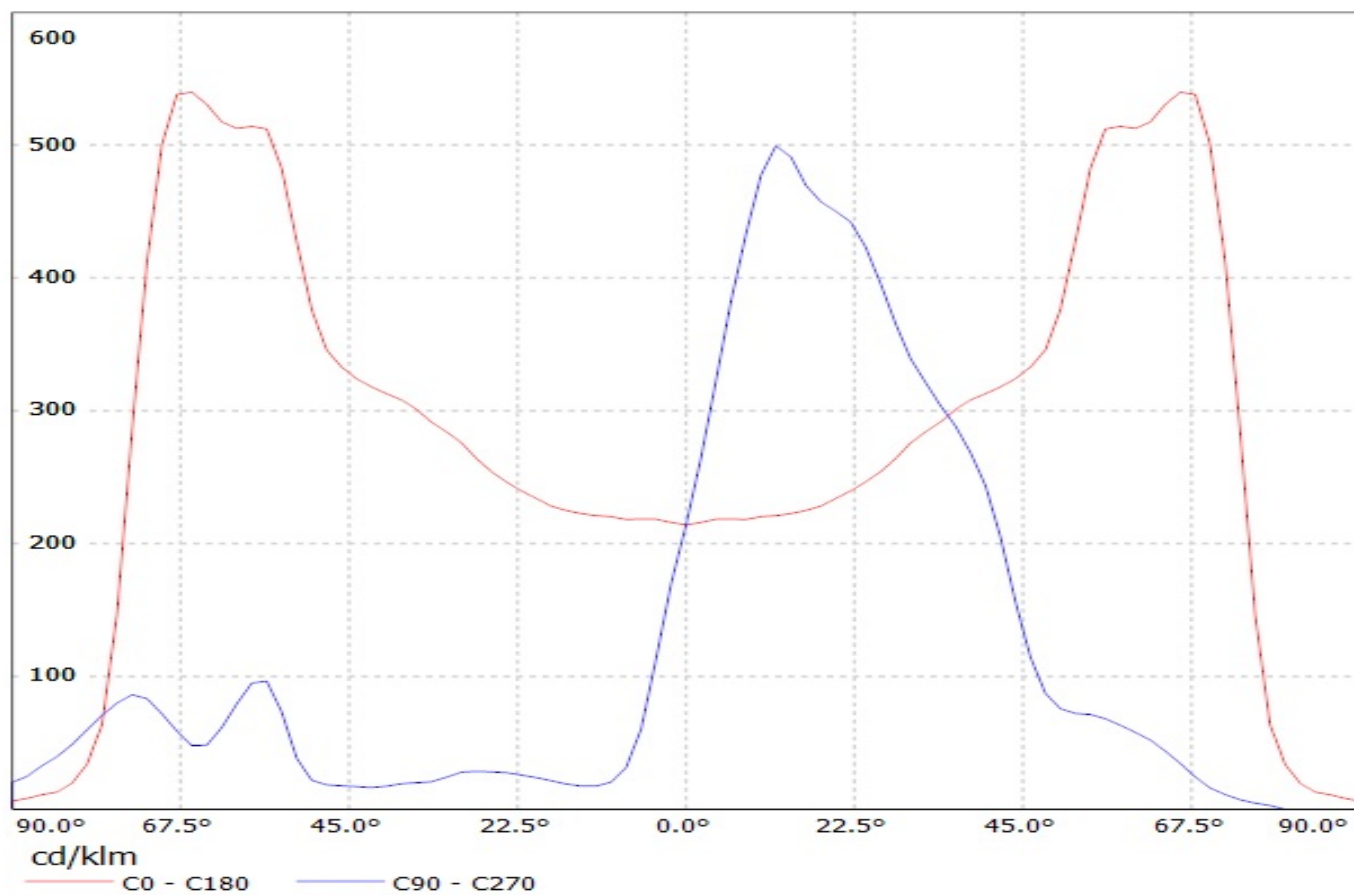

Luminaire: Ledil C13300\_STRADA-2X2-T2\_(Z8Y22plus)

Lamps: 1 x Seoul\_Z8Y22plus\_(W6E2G)\_513.996lm@250mA\_P=2.754W\_I=0.250A

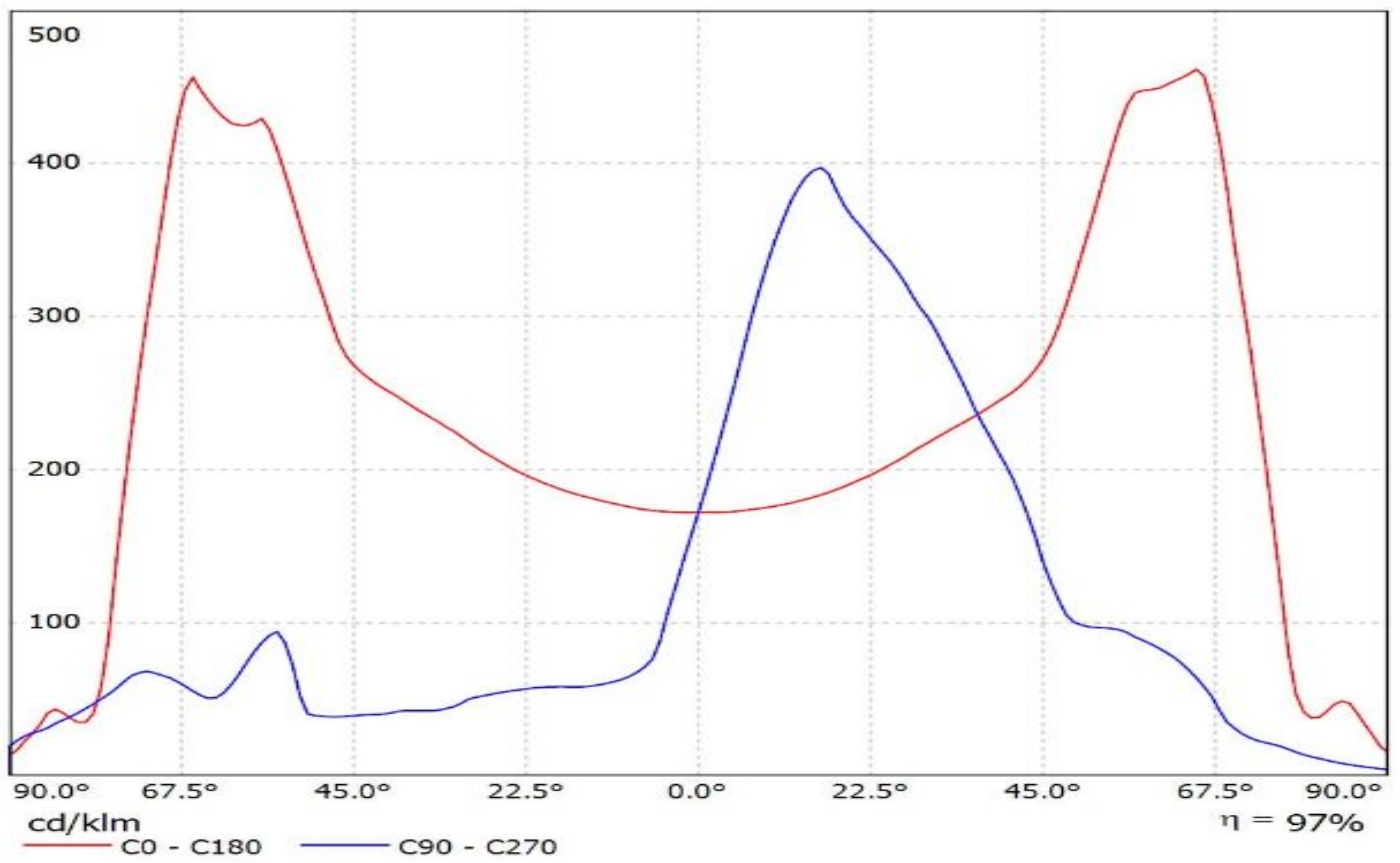

# Ledil C13300\_STRADA-2X2-T2\_(TL1L3) / LDC (Linear)

Luminaire: Ledil C13300\_STRADA-2X2-T2\_(TL1L3)

Lamps: 1 x Toshiba\_TL1L3\_2x2\_(TL1L3-NW1.L)\_387.773lm@250mA\_CCT=5000K\_P=2.829W\_I=0.25A

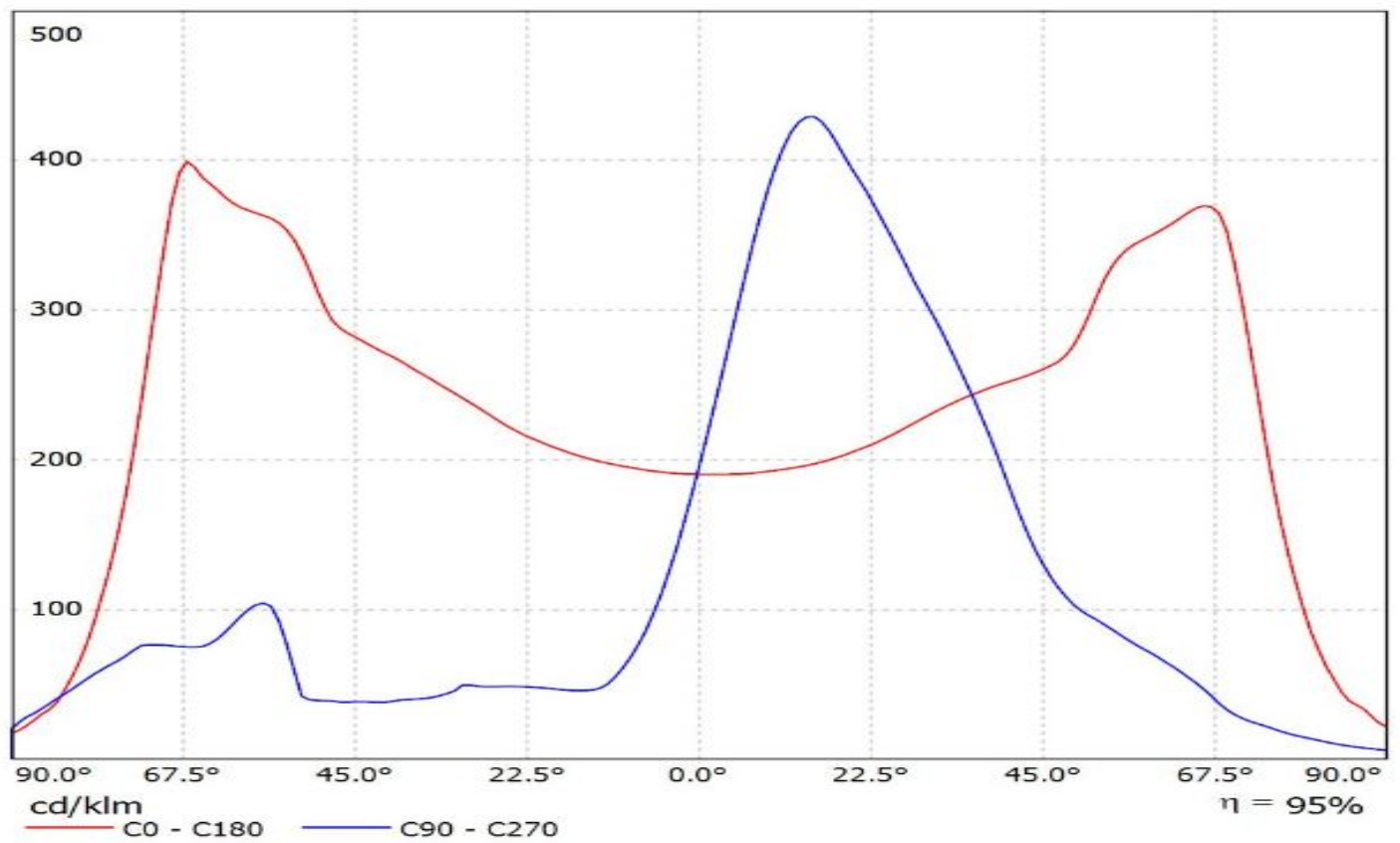

# Ledil C13300\_STRADA-2X2-T2\_(TL1L4) / LDC (Linear)

Luminaire: Ledil C13300\_STRADA-2X2-T2\_(TL1L4)

Lamps: 1 x Toshiba\_TL1L4\_2x2\_(TL1L4-DW0)\_472.639lm@250mA\_CCT=6500K\_P=2.9W\_I=0.25A

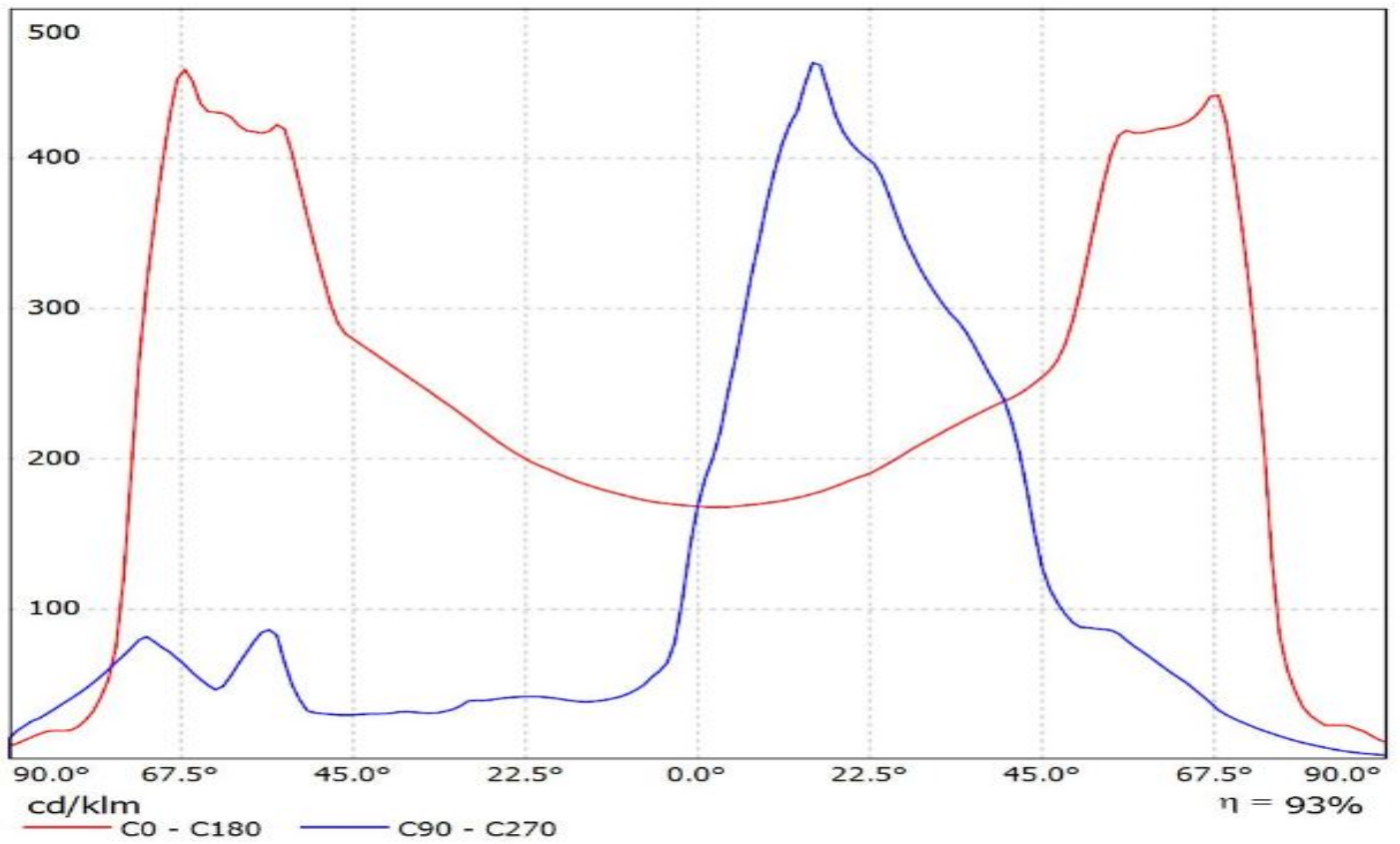

Luminaire: LEDiL Oy C13300\_STRADA-2X2-T2(Tridonic\_Module\_RLE\_G1)  
Lamps: 1 x Tridonic\_Module\_RLE\_G1\_4576.03lm@700mA\_P=32.0681W\_I=0.700A

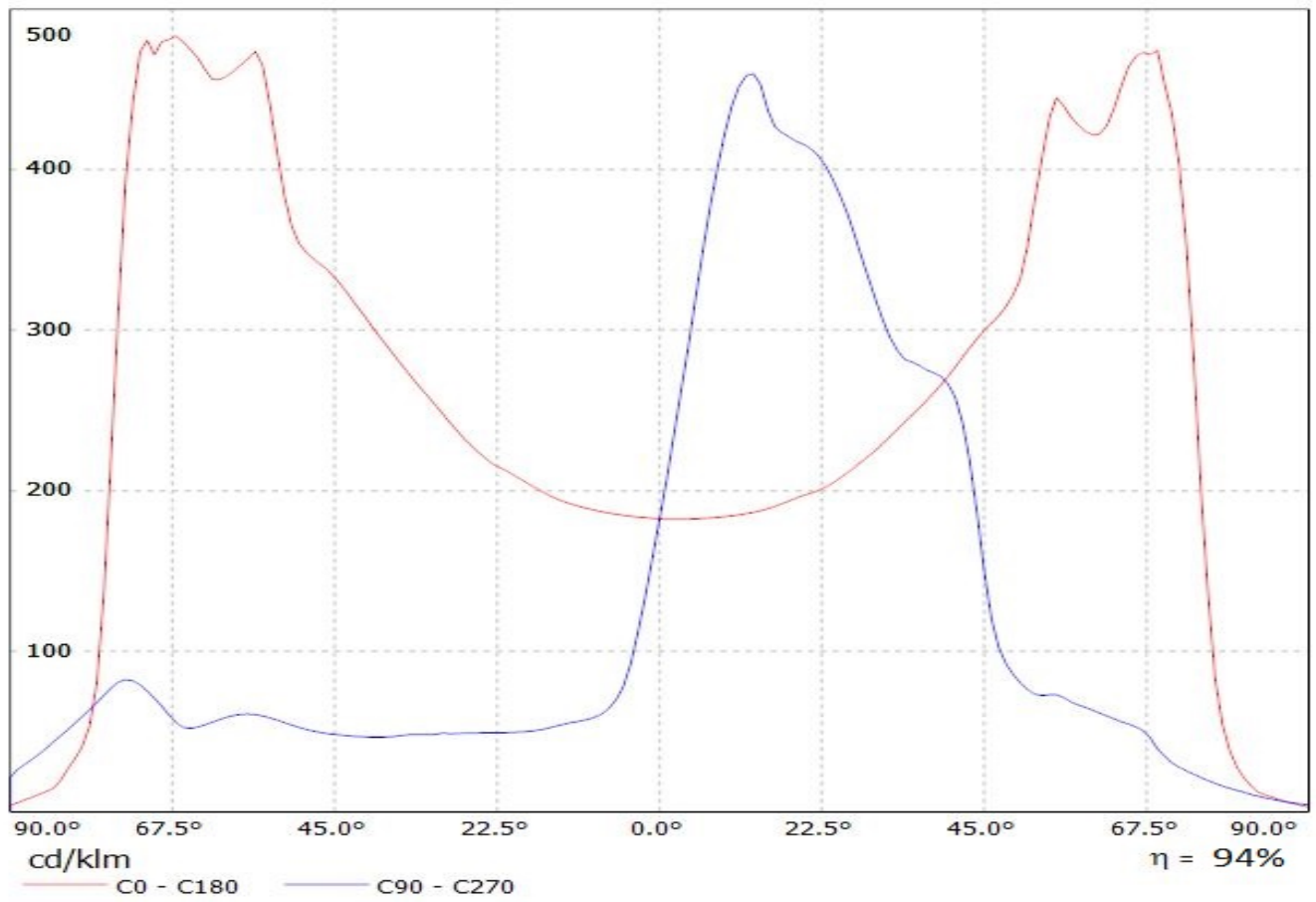

Luminaire: LEDiL Oy C13300\_STRADA-2X2-T2(Tridonic\_Module\_RLE\_G1)  
Lamps: 1 x Tridonic\_Module\_RLE\_G1\_4576.03lm@700mA\_P=32.0681W\_I=0.700A

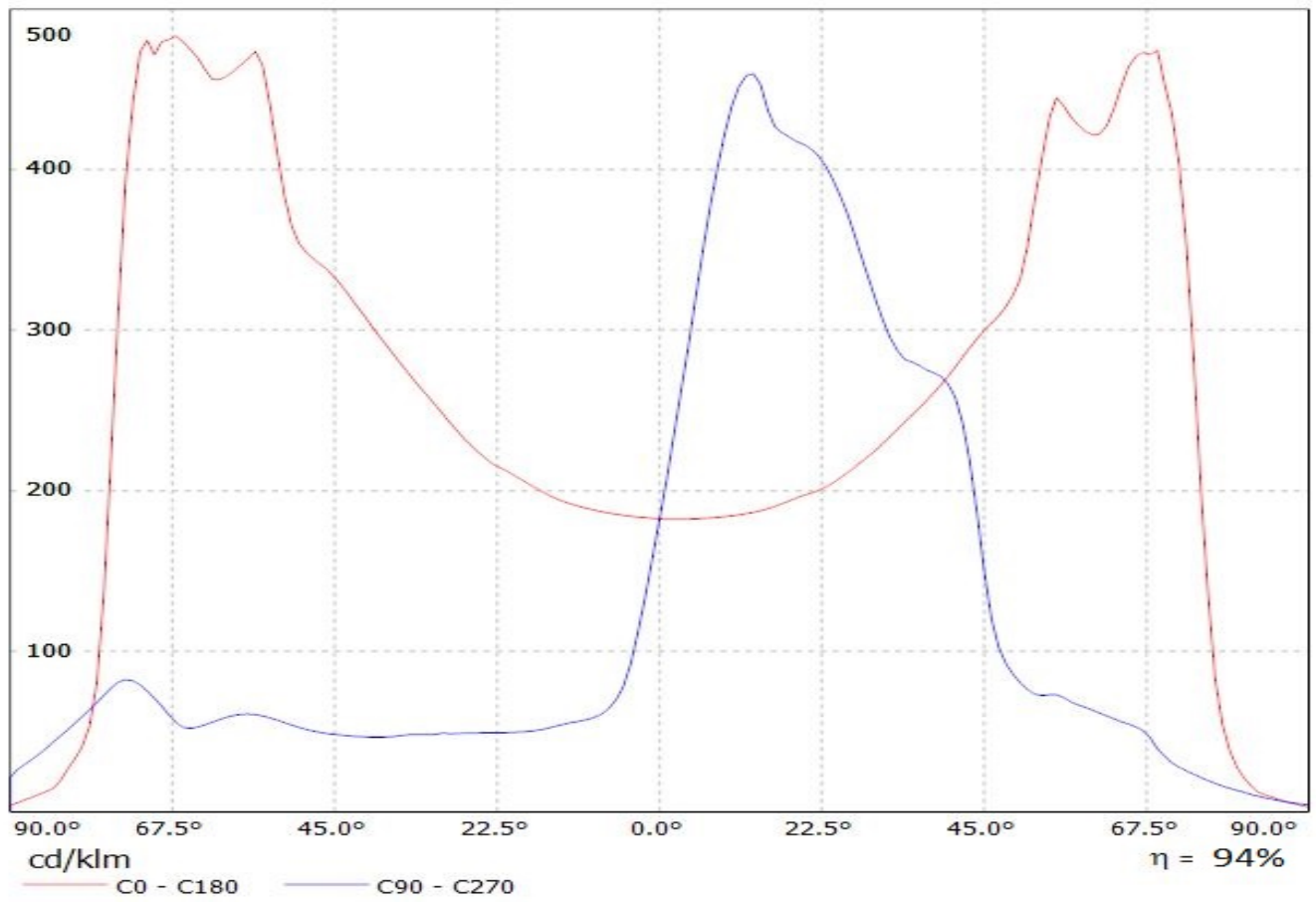

Luminaire: LEDiL Oy C13300\_STRADA-2X2-T2(Tridonic\_Module\_RLE\_G1)  
Lamps: 1 x Tridonic\_Module\_RLE\_G1\_2288lm@700mA\_P=16W\_I=0.700A

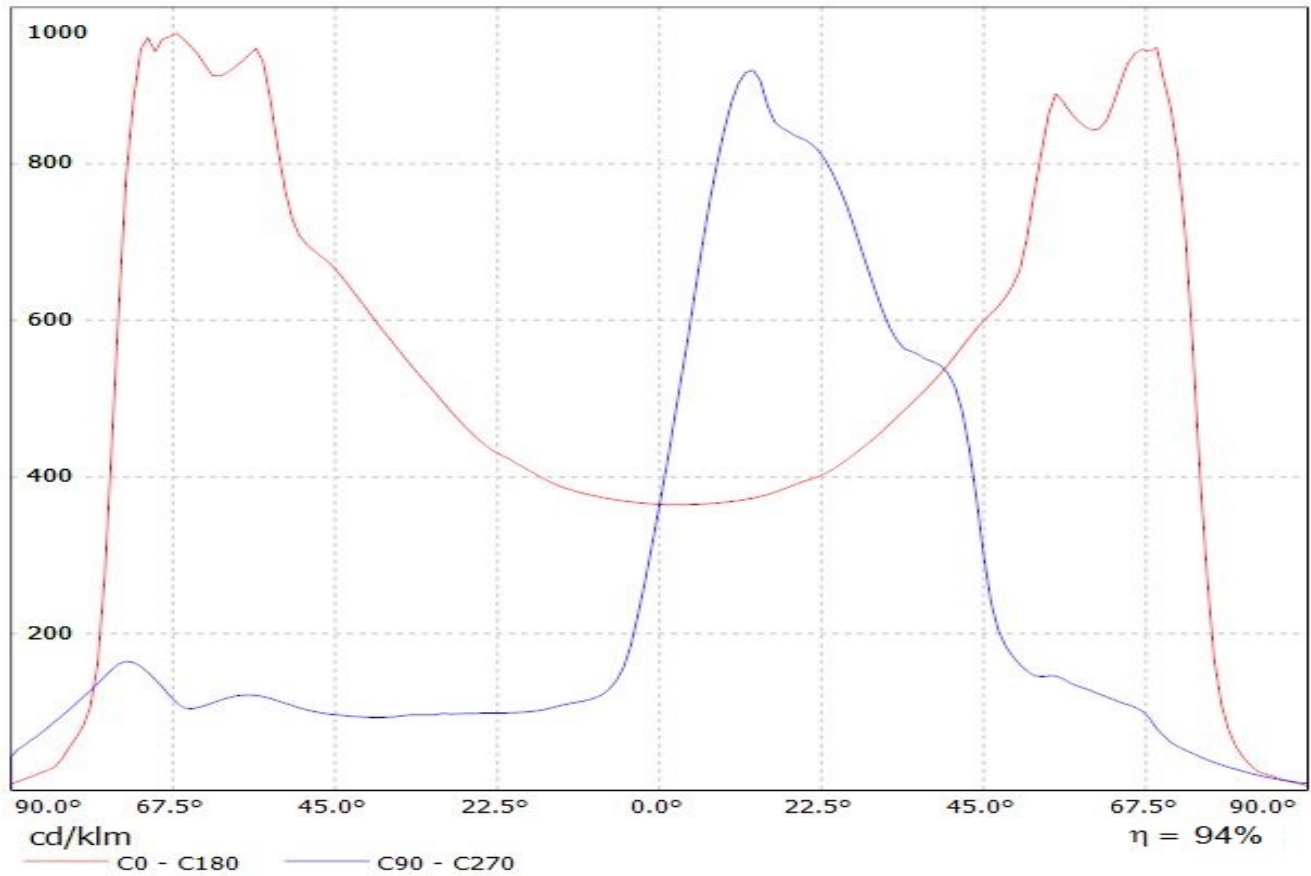



Luminaire: LEDiL Oy C13300\_STRADA-2X2-T2(Tridonic\_Module\_RLE\_G1)  
Lamps: 1 x Tridonic\_Module\_RLE\_G1\_2288lm@700mA\_P=16W\_I=0.700A

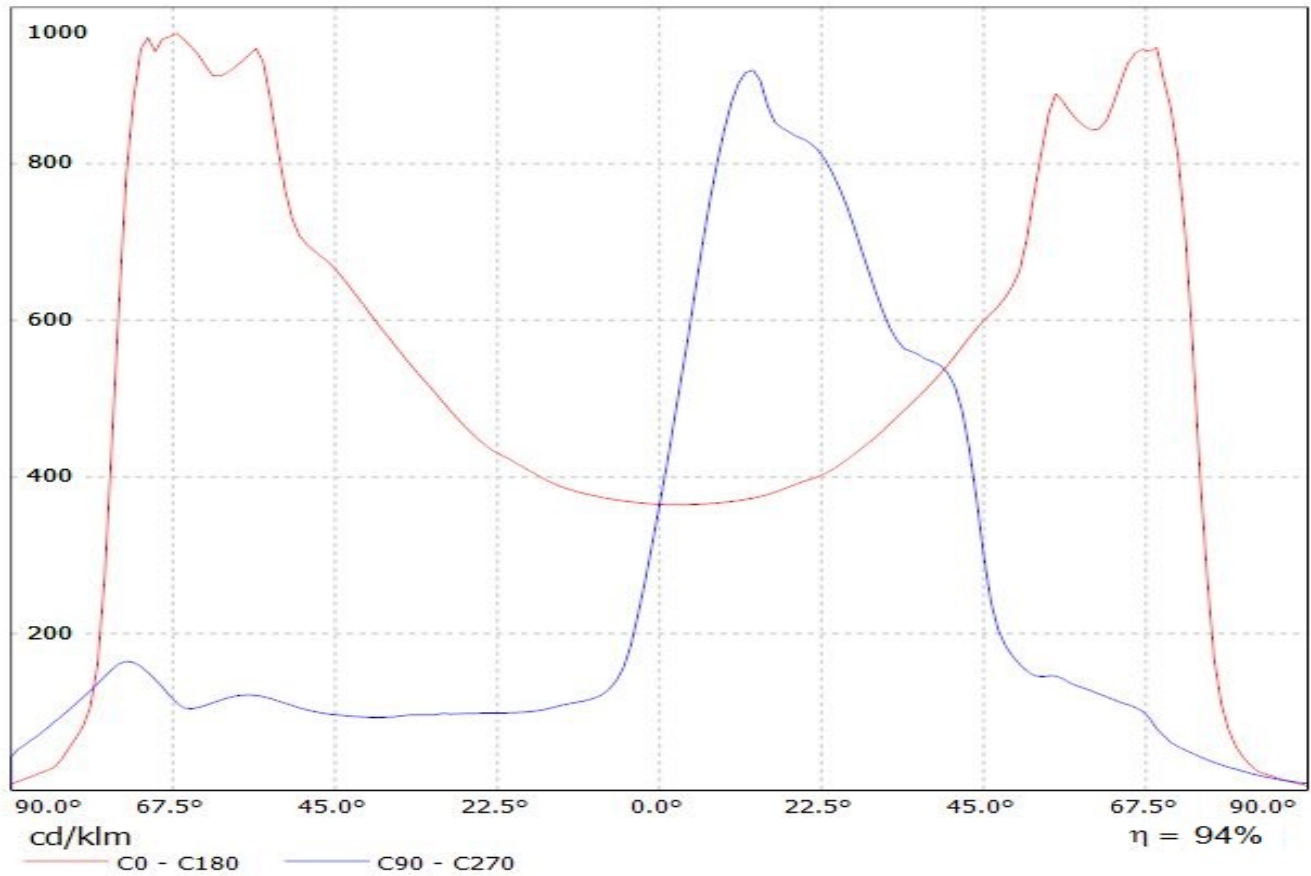

# LEDiL Oy C13300\_STRADA-2X2-T2\_(XP-G) Eff.97.9% / LDC (Polar)

Luminaire: LEDiL Oy C13300\_STRADA-2X2-T2\_(XP-G) Eff.97.9%

Lamps: 1 x XP-G (249lm@250mA)

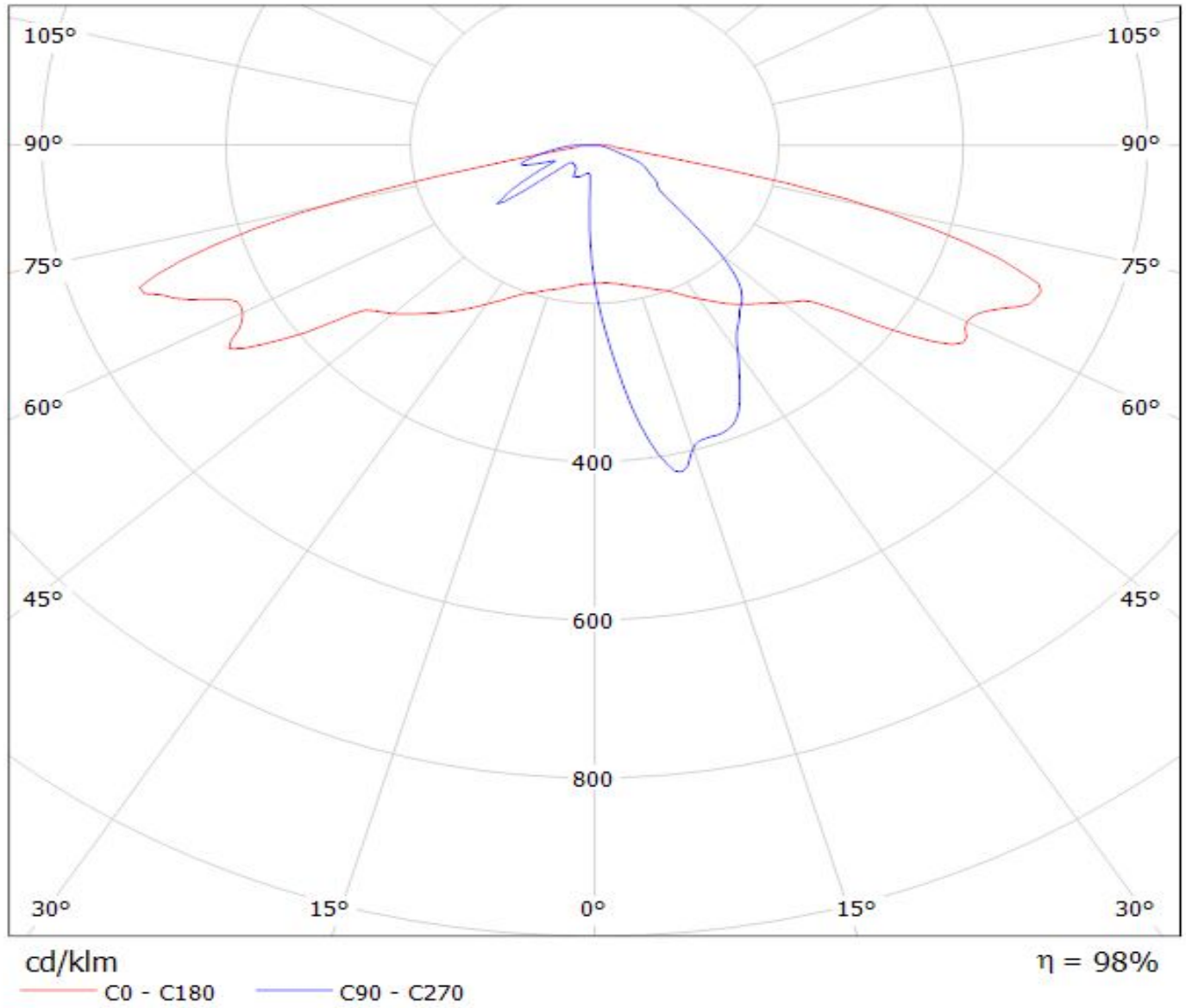

# LEDiL Oy C13300\_STRADA-2X2-T2\_(XM-L) Eff.95.1% / LDC (Polar)

Luminaire: LEDiL Oy C13300\_STRADA-2X2-T2\_(XM-L) Eff.95.1%

Lamps: 1 x XM-L (357lm@250mA)

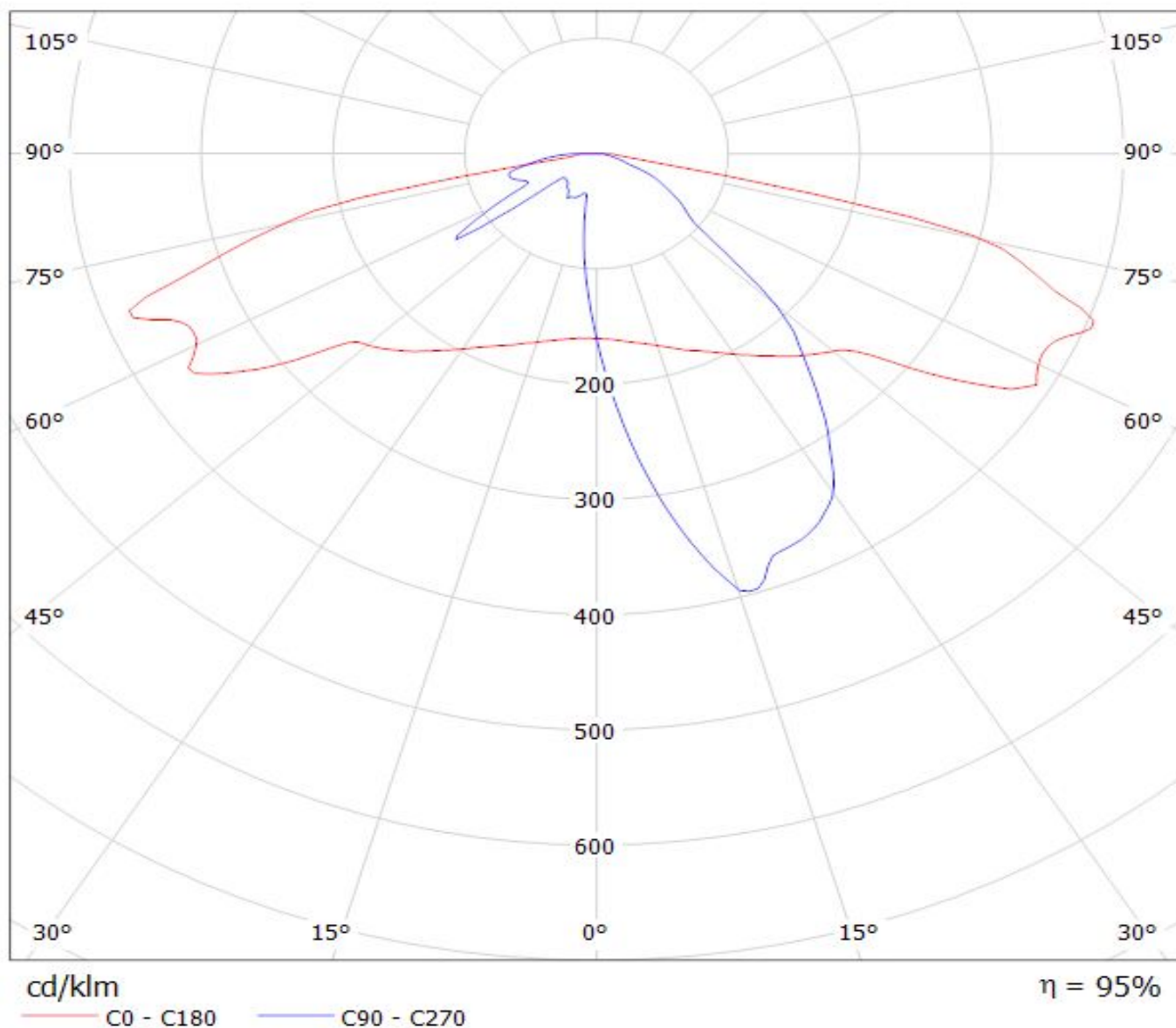

# LEDiL Oy C13300\_STRADA-2X2-T2\_(XB-D) Eff.94.2% / LDC (Polar)

Luminaire: LEDiL Oy C13300\_STRADA-2X2-T2\_(XB-D) Eff.94.2%  
Lamps: 1 x XM-L (370lm@250mA)

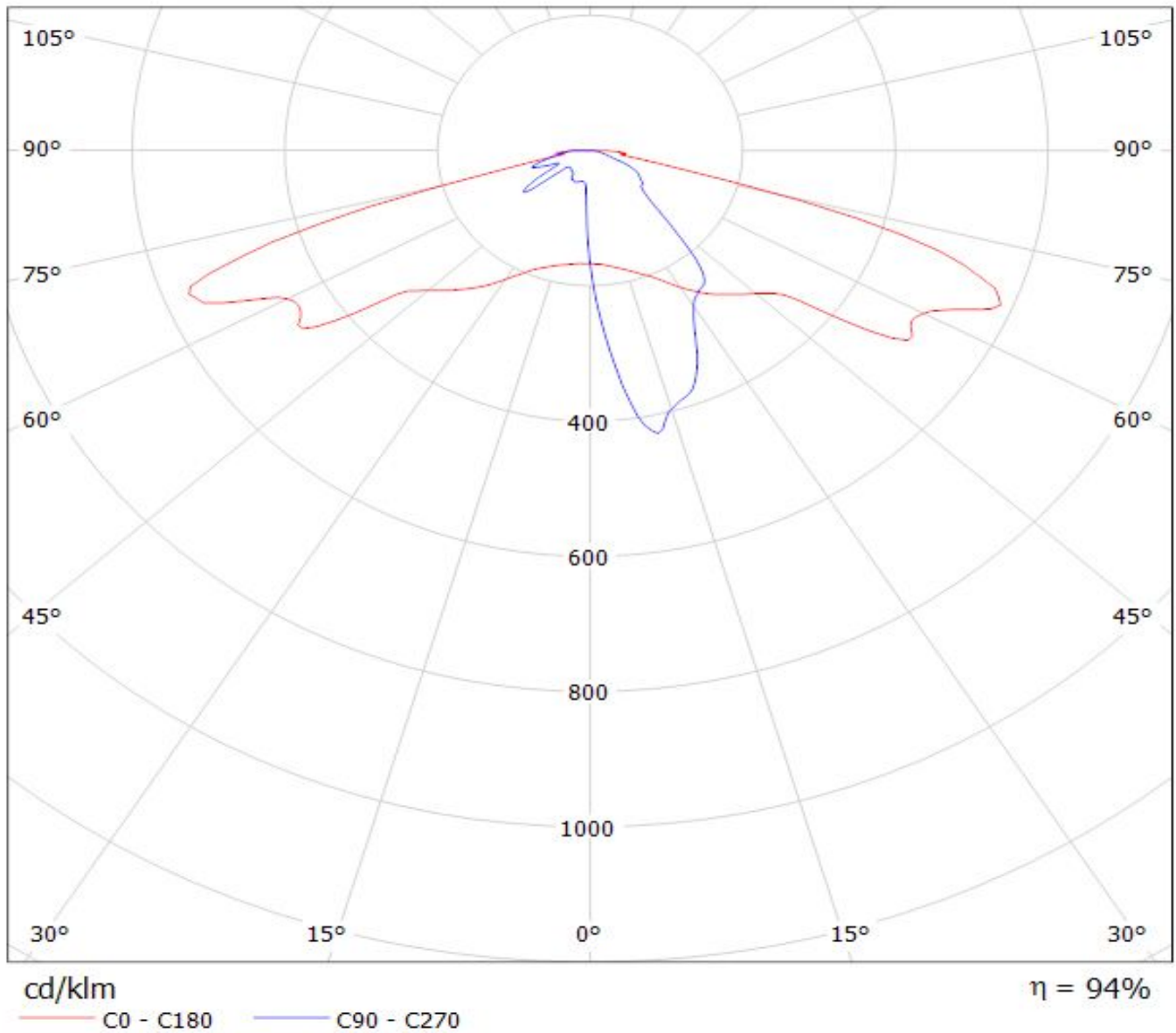

# LEDiL Oy C13300\_STRADA-2X2-T2\_(XP-G2) Eff.90.9% / LDC (Polar)

Luminaire: LEDiL Oy C13300\_STRADA-2X2-T2\_(XP-G2) Eff.90.9%

Lamps: 1 x XP-G2 (433lm@250mA)

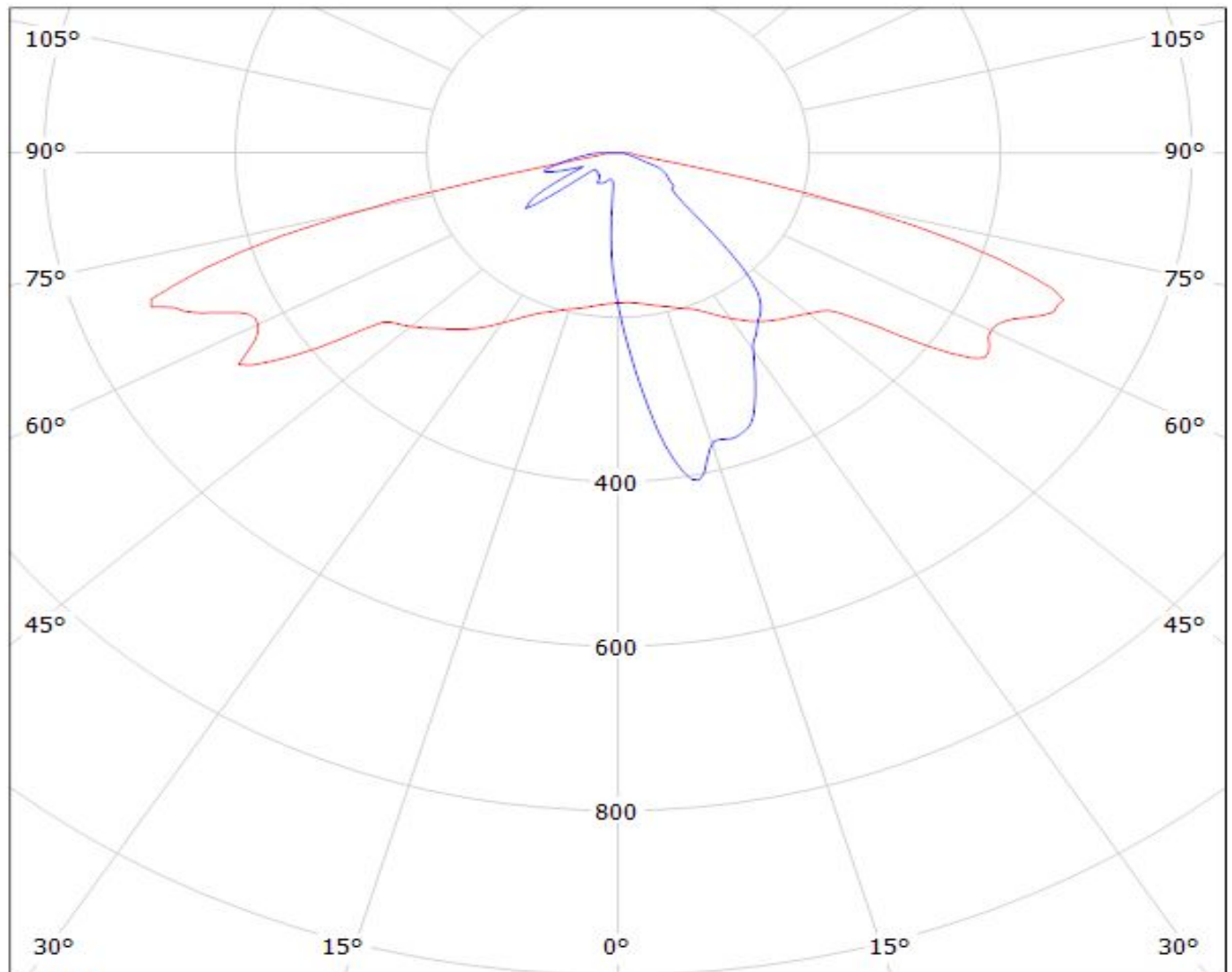

cd/klm

— C0 - C180

— C90 - C270

$\eta = 91\%$

# LEDiL Oy C13300\_STRADA-2X2-T2\_(XM-L2) Eff.94.5% / LDC (Polar)

Luminaire: LEDiL Oy C13300\_STRADA-2X2-T2\_(XM-L2) Eff.94.5%

Lamps: 1 x XM-L2 (366lm@250mA)

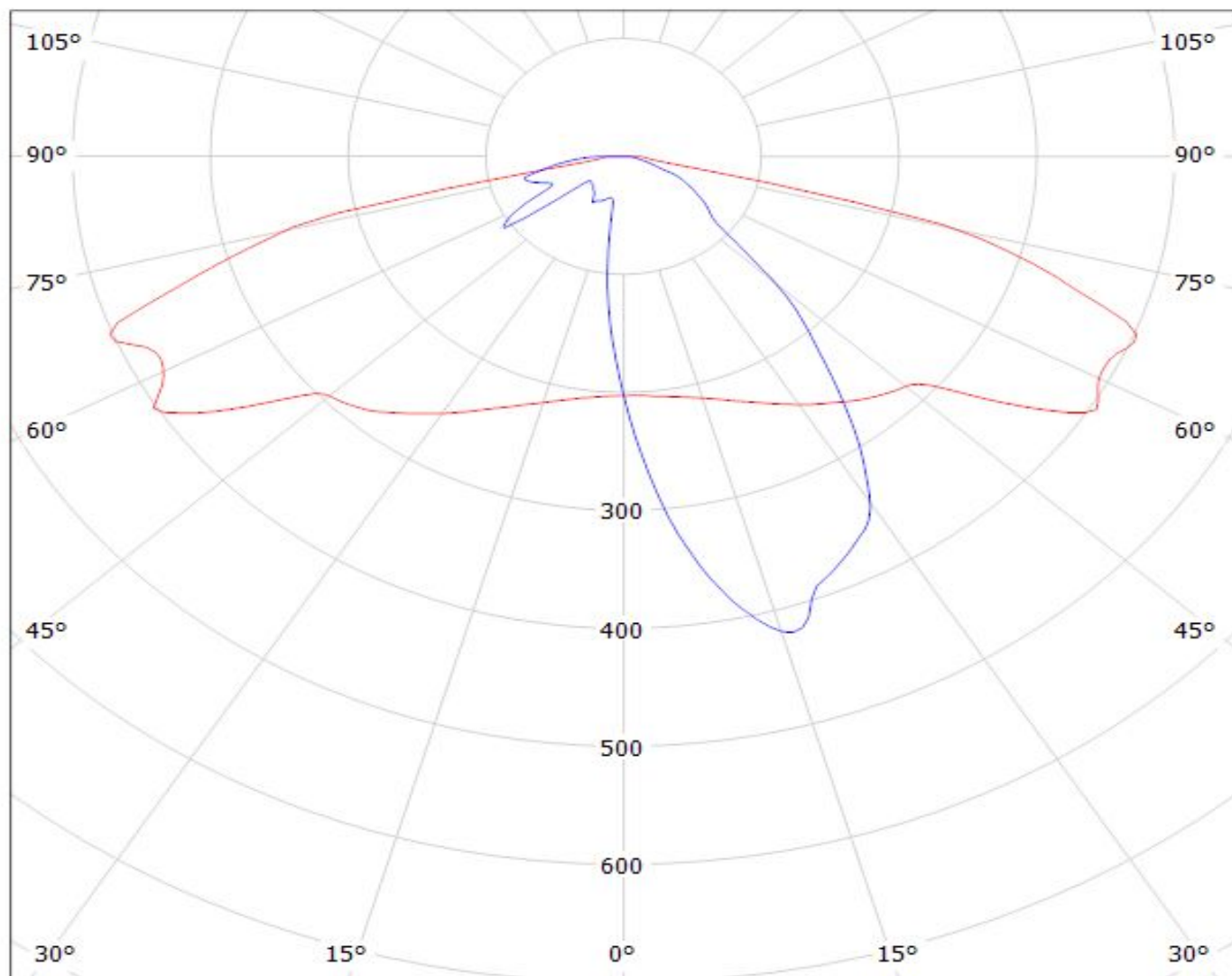

cd/klm

η = 95%

— C0 - C180

— C90 - C270

Luminaire: LEDiL Oy C13300\_STRADA-2x2-T2\_(XP-L)

Lamps: 1 x CREE\_XP-L\_2x2\_(XPLAWT-0-1B0-V40-00-0001)\_508.75lm@250mA\_CCT=7600K\_P=2.79963W\_I=249.9mA

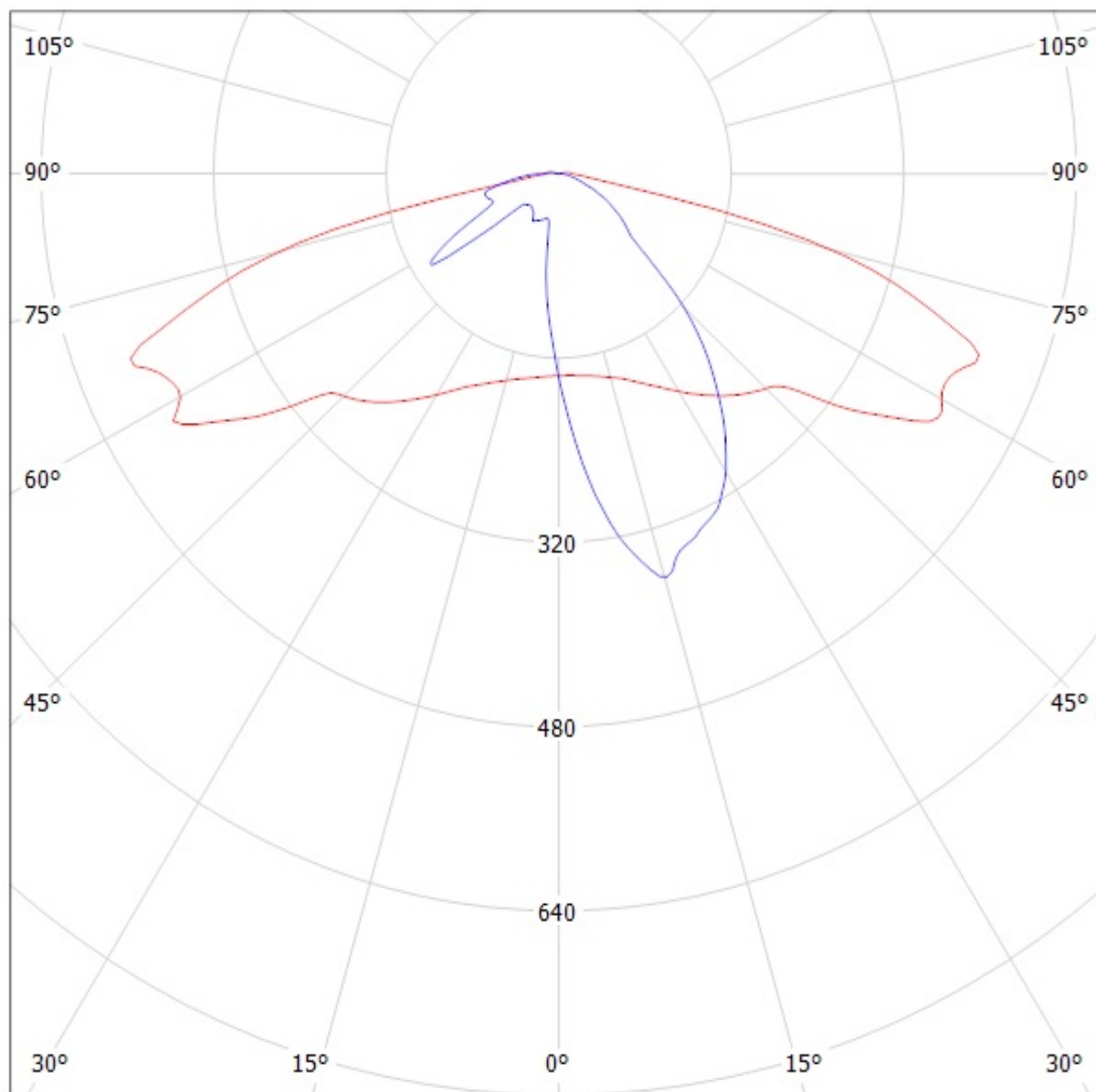

cd/klm

— C0 - C180    — C90 - C270

$\eta = 94\%$

Luminaire: LEDiL Oy C13300\_STRADA-2X2-T2\_(XP-L\_HI)  
Lamps: 1 x Cree\_XP-L\_HI\_(2x2)\_(XPLAWT-H-5A3-U60-013-0001)  
\_455.077lm@250mA\_P=2.84011W\_I=0,2499A

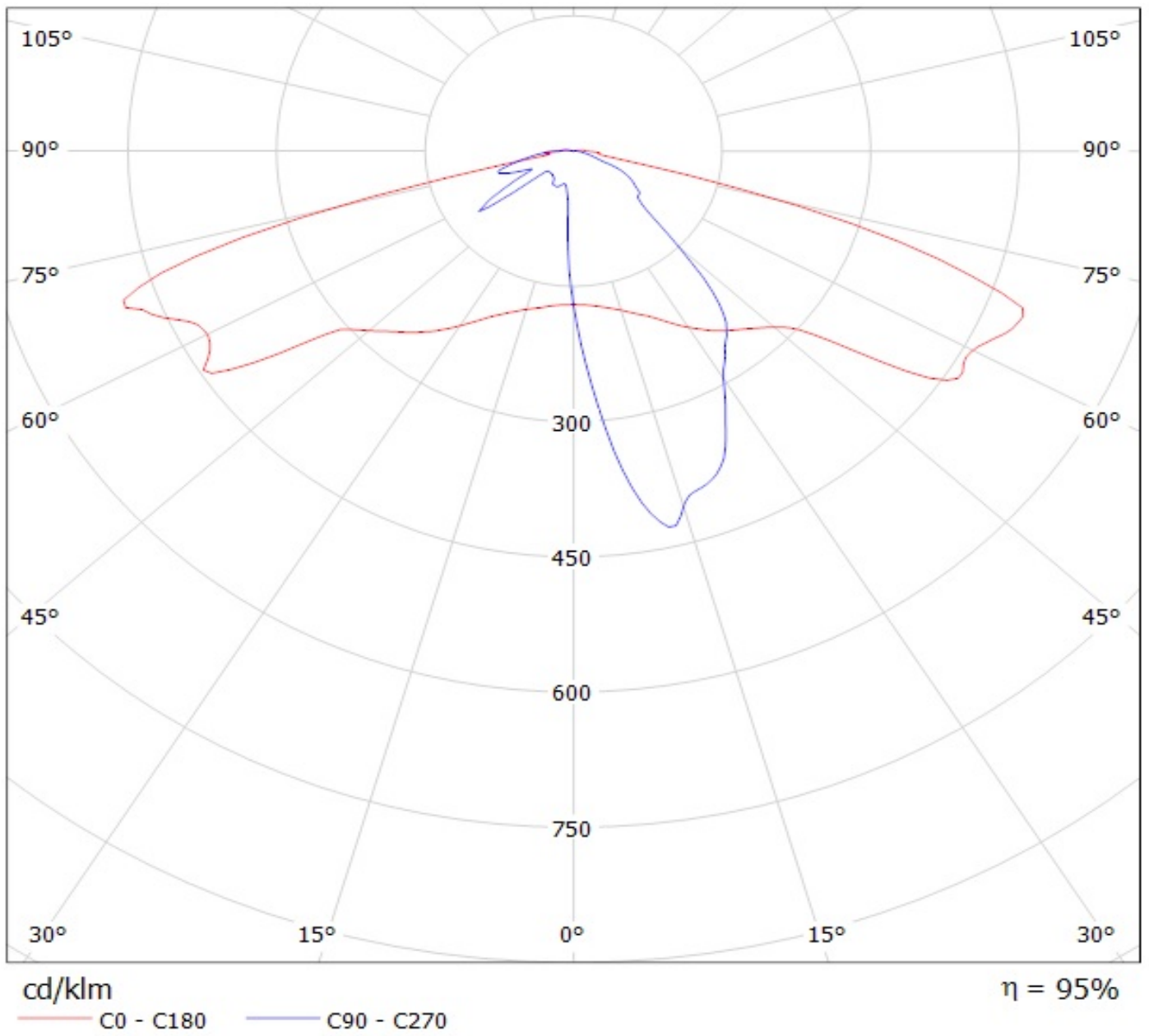



Luminaire: Ledil C13300\_STRADA-2X2-T2\_(XP-L2)

Lamps: 1 x Cree\_XP-L2\_2x2\_(XPLBWT-00-0000-000BV50E3)550.93lm@250mA\_P=2.7815W\_I=0.25A

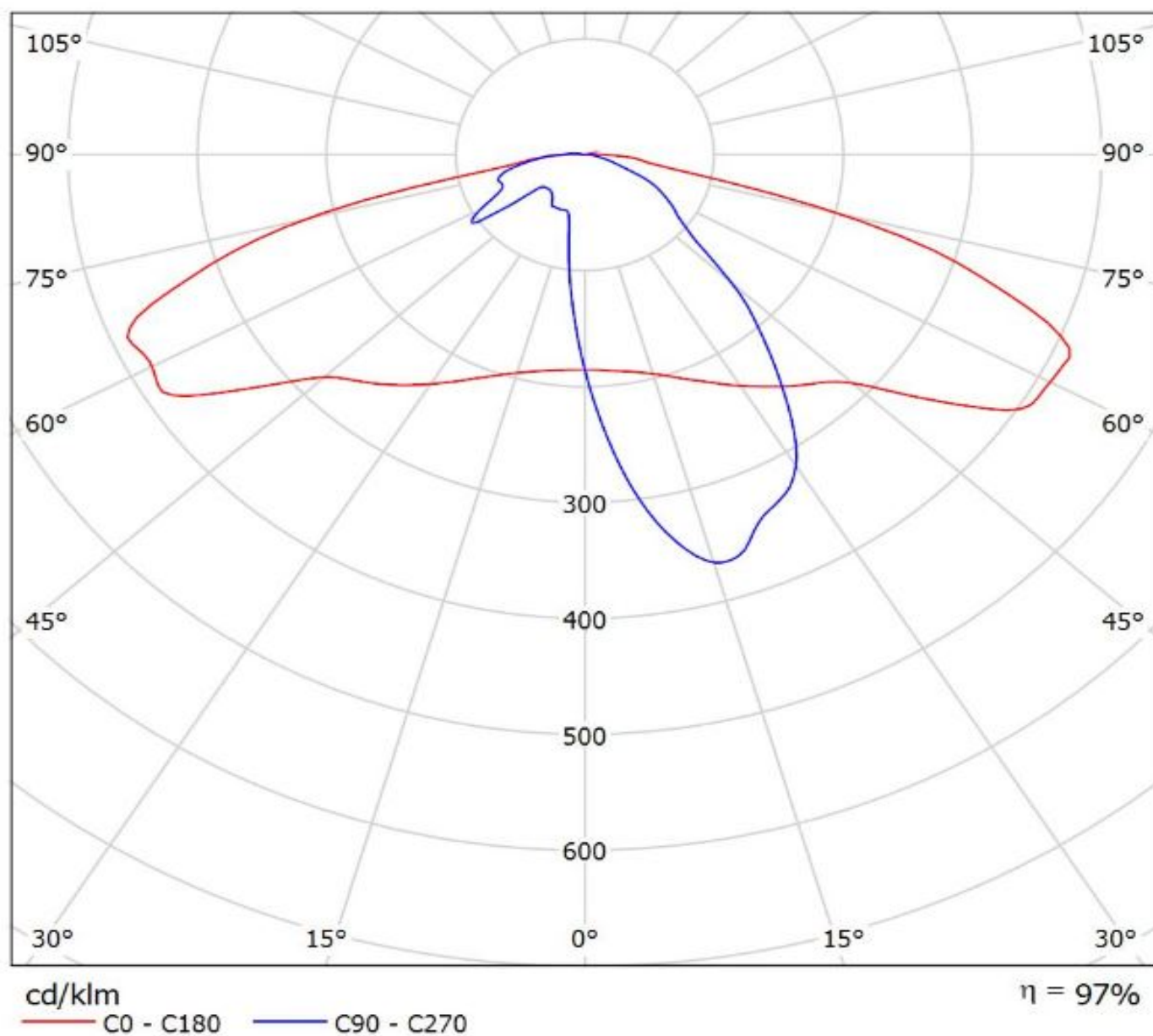

# LEDiL Oy C13300\_STRADA-2X2-T2\_(LG\_3535) Eff.94.2% / LDC (Polar)

Luminaire: LEDiL Oy C13300\_STRADA-2X2-T2\_(LG\_3535) Eff.94.2%

Lamps: 1 x LG\_3535\_Ceramic\_2x2 (374lm@250mA)

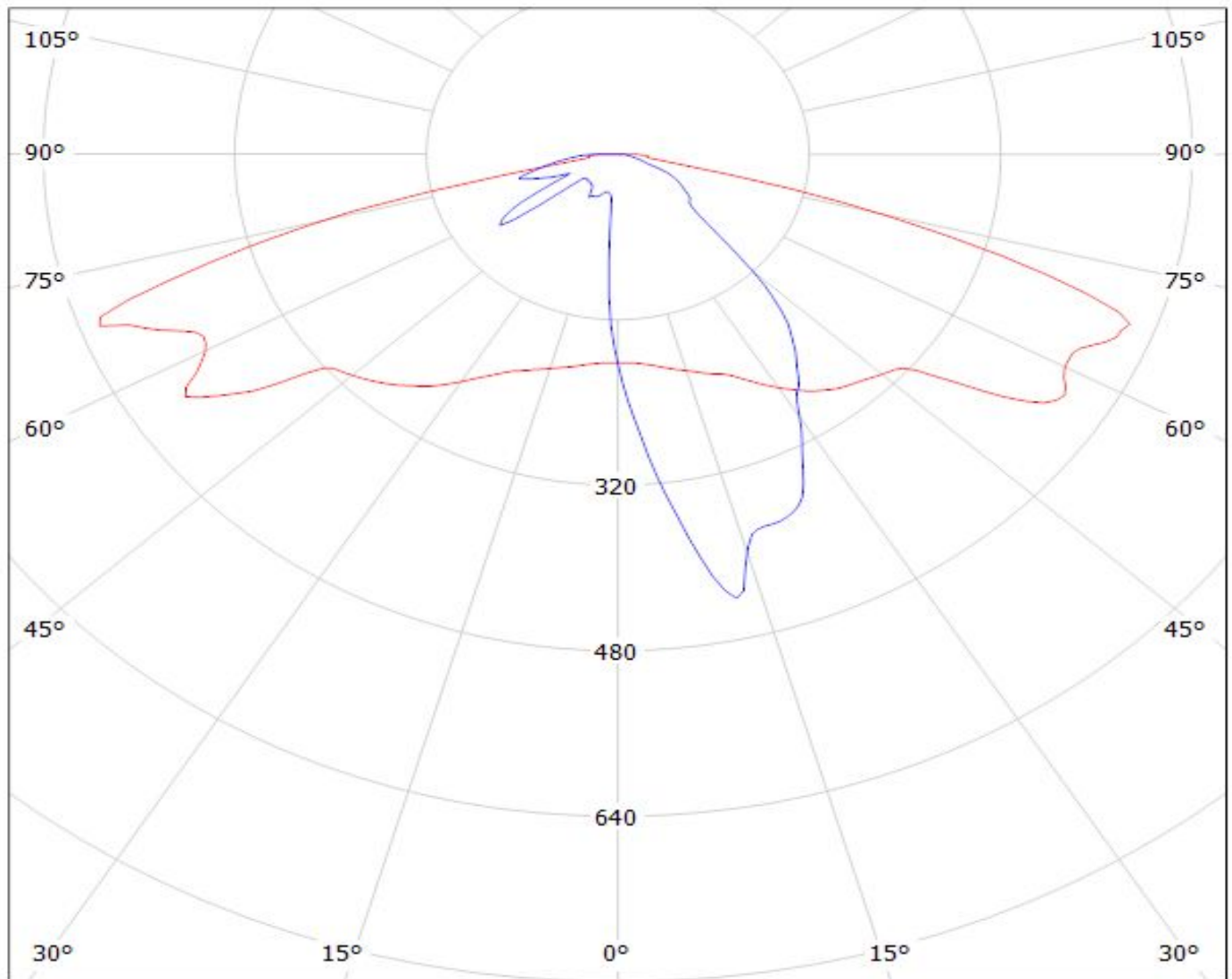

cd/klm

— C0 - C180

— C90 - C270

$\eta = 94\%$

# LEDiL Oy C13300\_STRADA-2X2-T2\_(LG-3535-CERAMIC-GEN2) Eff.94.0% / LDC (Polar)

Luminaire: LEDiL Oy C13300\_STRADA-2X2-T2\_(LG-3535-CERAMIC-GEN2) Eff.94.0%

Lamps: 1 x LG-3535-CERAMIC-GEN2\_2x2\_472.9lm@250mA\_P=2.8651W\_CCT=6562K\_I=249.9mA

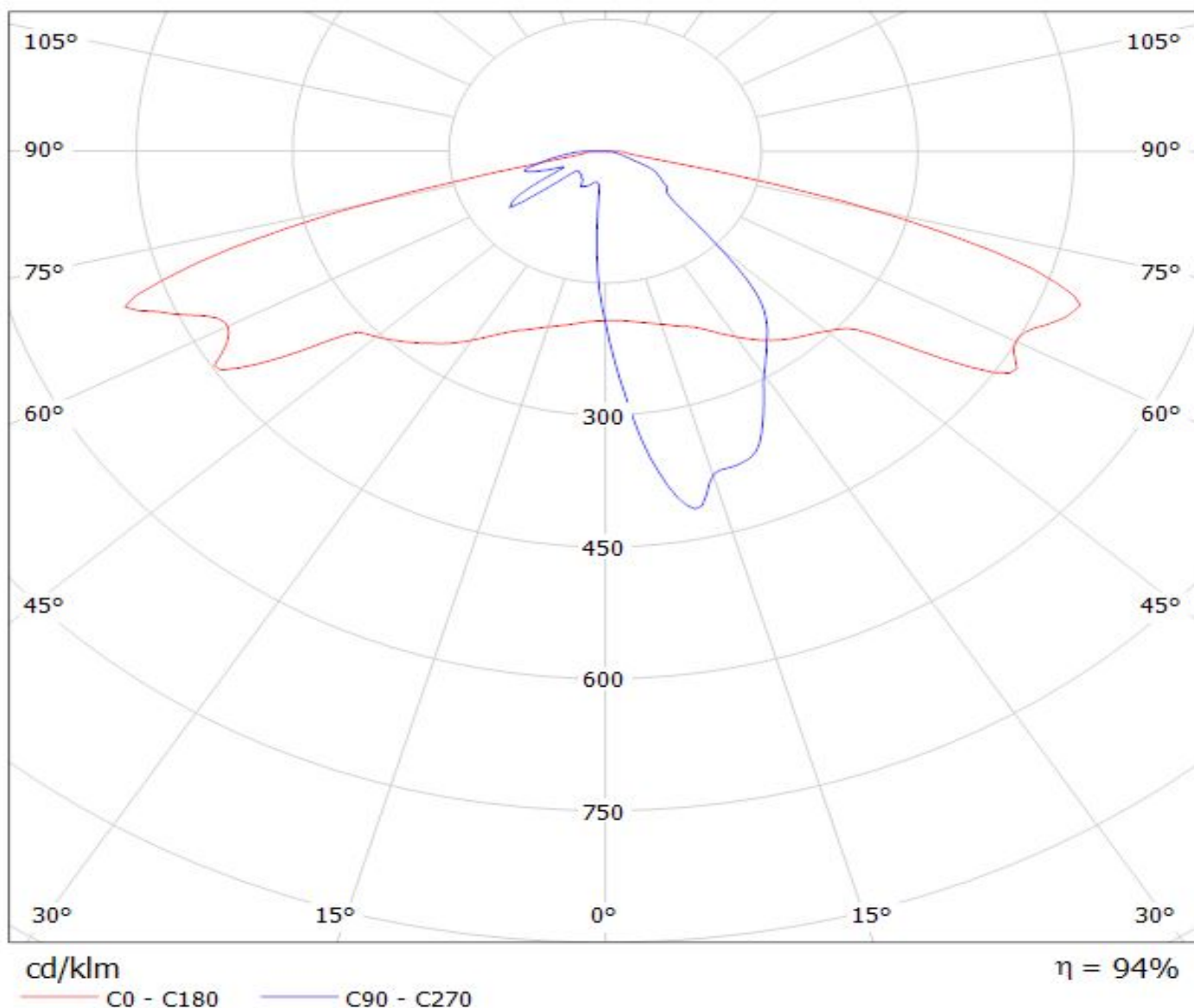

# LEDiL Oy C13300\_STRADA-2X2-T2\_(LUXEON\_R) Eff.95.8% / LDC (Polar)

Luminaire: LEDiL Oy C13300\_STRADA-2X2-T2\_(LUXEON\_R) Eff.95.8%

Lamps: 1 x LUXEON\_R (303lm@250mA)

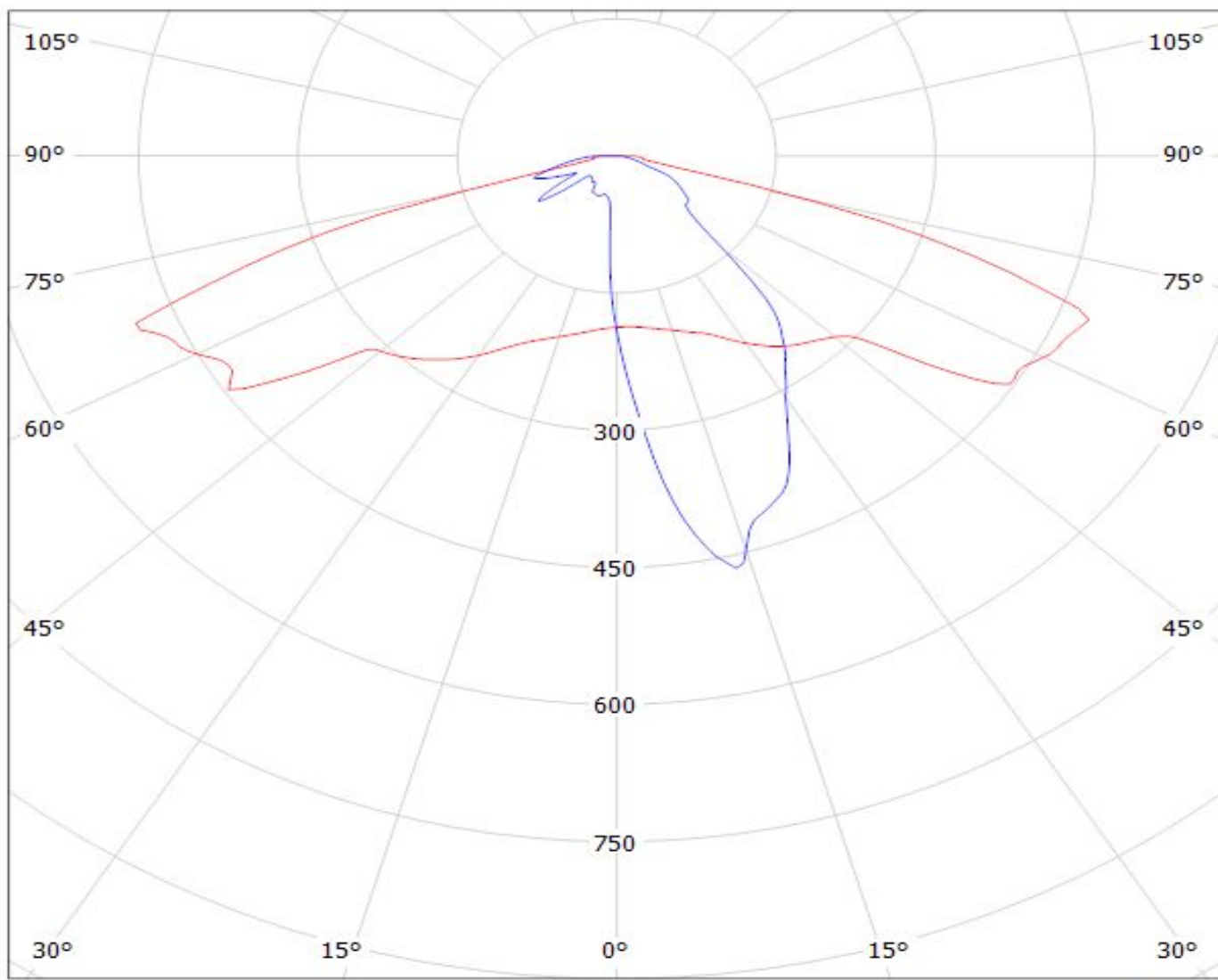

cd/klm

— C0 - C180

— C90 - C270

$\eta = 96\%$

# LEDiL Oy C13300\_STRADA-2X2-T2\_(REBEL\_ES) Eff.94.5% / LDC (Polar)

Luminaire: LEDiL Oy C13300\_STRADA-2X2-T2\_(REBEL\_ES) Eff.94.5%

Lamps: 1 x XM-L (338lm@250mA)

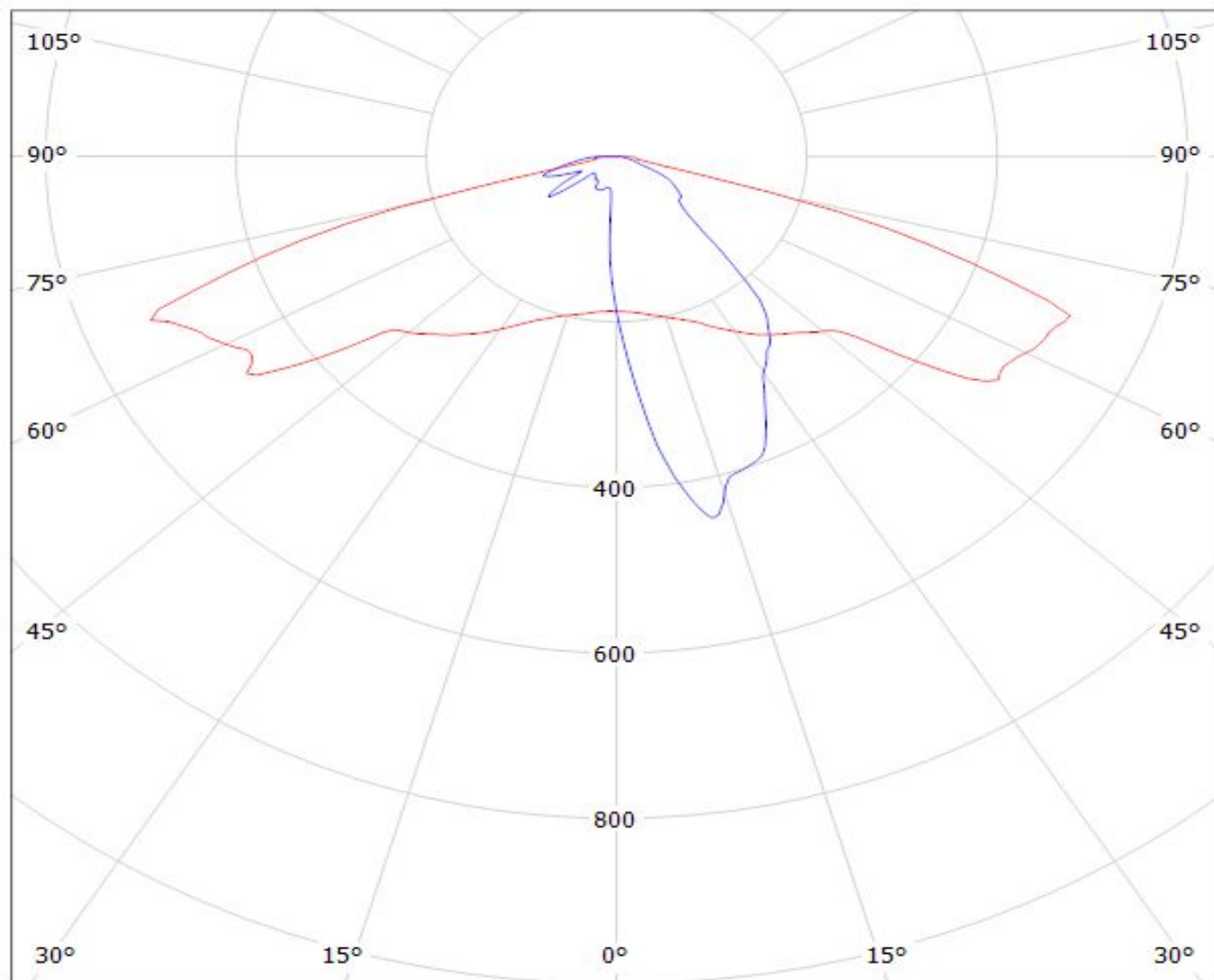

cd/klm

— C0 - C180

— C90 - C270

$\eta = 95\%$

Luminaire: LEDiL Oy C13300\_STRADA-2x2-T2\_(LUXEON\_T) Eff.94.1%

Lamps: 1 x LUXEON\_T 2x2 (294lm@250mA)

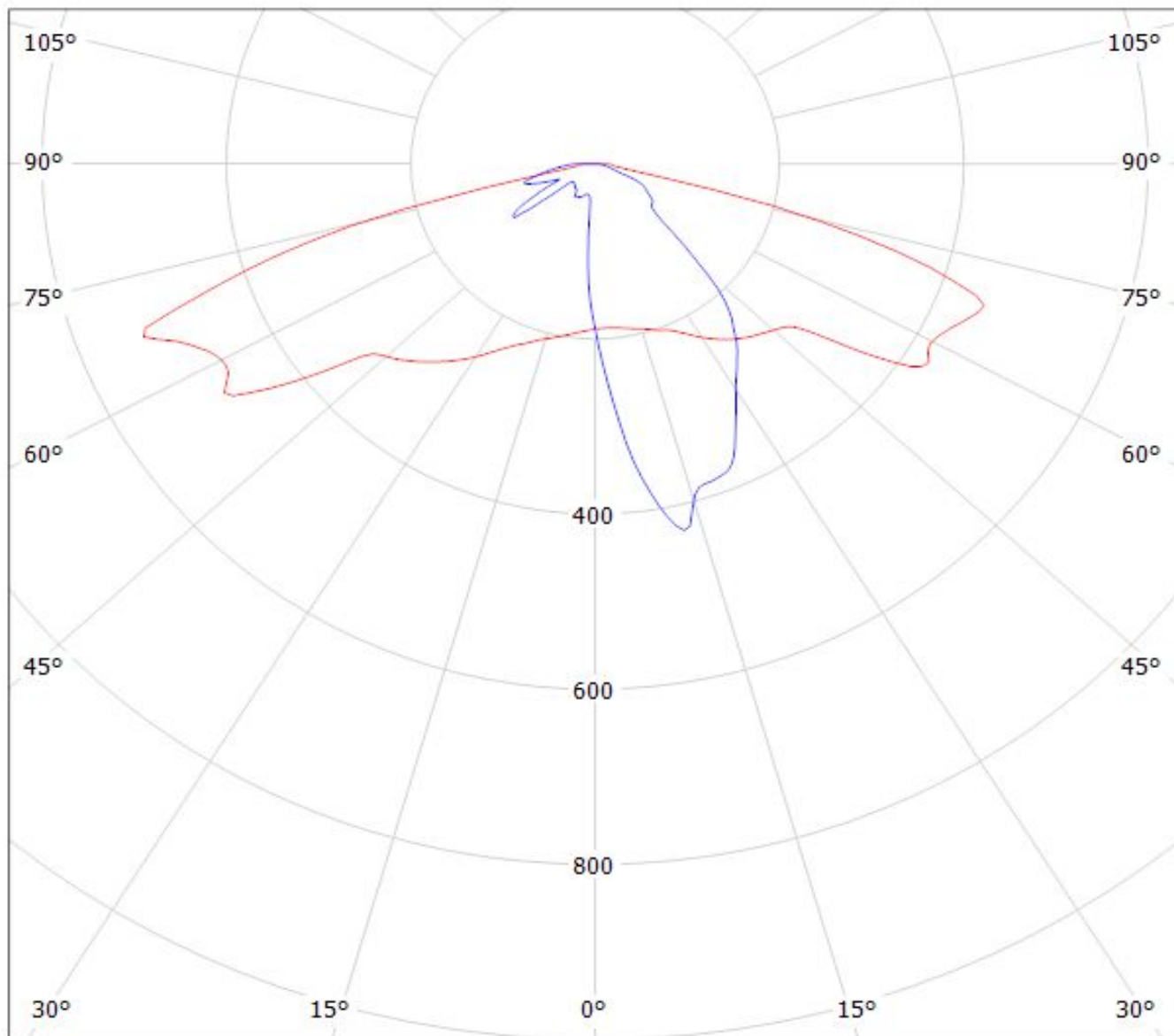

cd/klm

η = 94%

— C0 - C180 — C90 - C270

Luminaire: LEDiL Oy C13300\_STRADA-2X2-T2\_(Luxeon-Z-ES) Eff. 94%  
Lamps: 1 x Luxeon Z ES 2x2 (LX22-3090) 209.277lm@250mA\_P=2.81W\_I=0.2499A

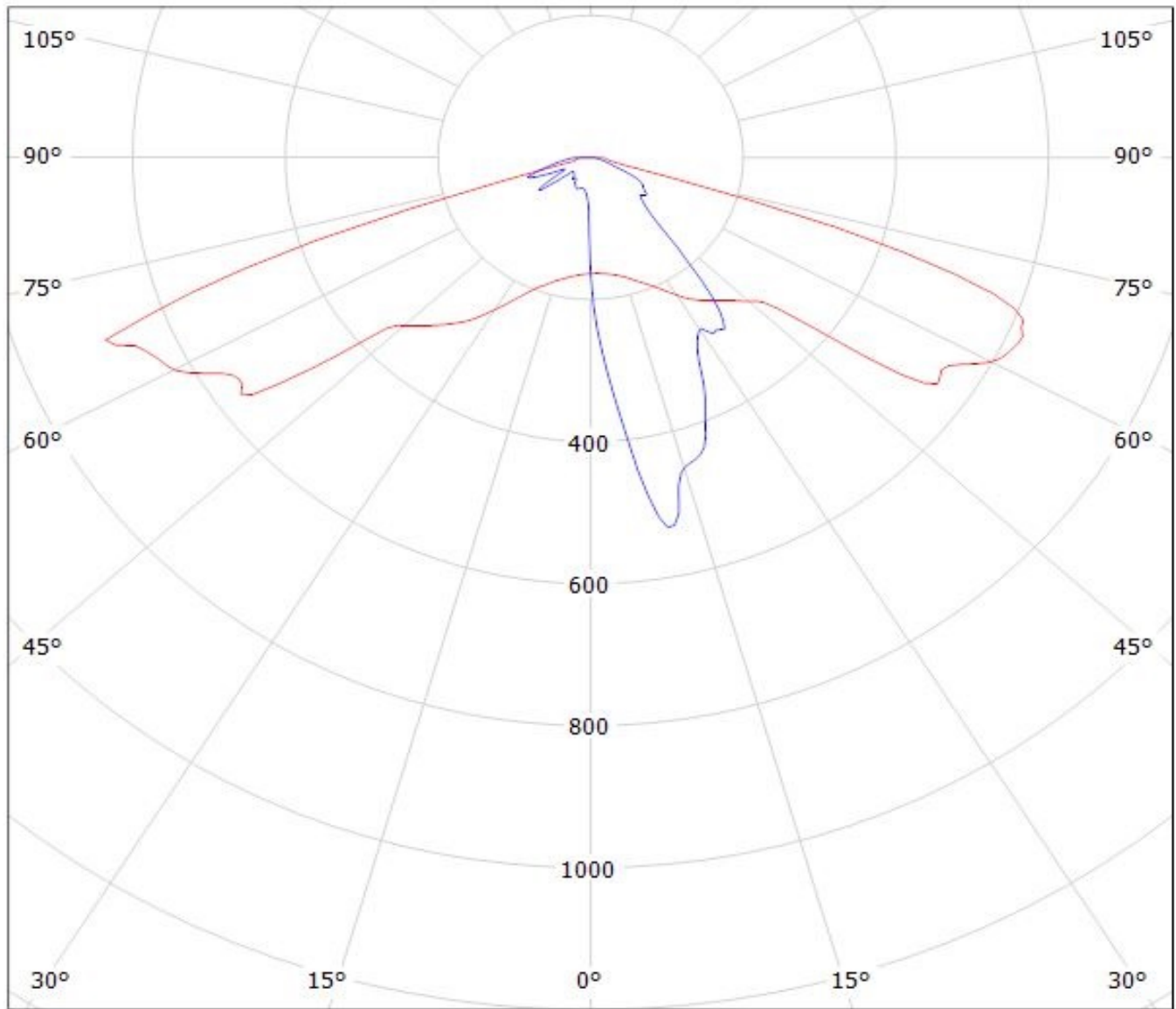

cd/klm  
— C0 - C180    — C90 - C270

Luminaire: LEDiL Oy C13300\_STRADA-2X2-T2\_(LUXEON\_Q)

Lamps: 1 x LUXEON\_Q\_2x2\_(LHQ-3080)\_298.363lm@250mA\_P=2.87385W\_I=249.9mA

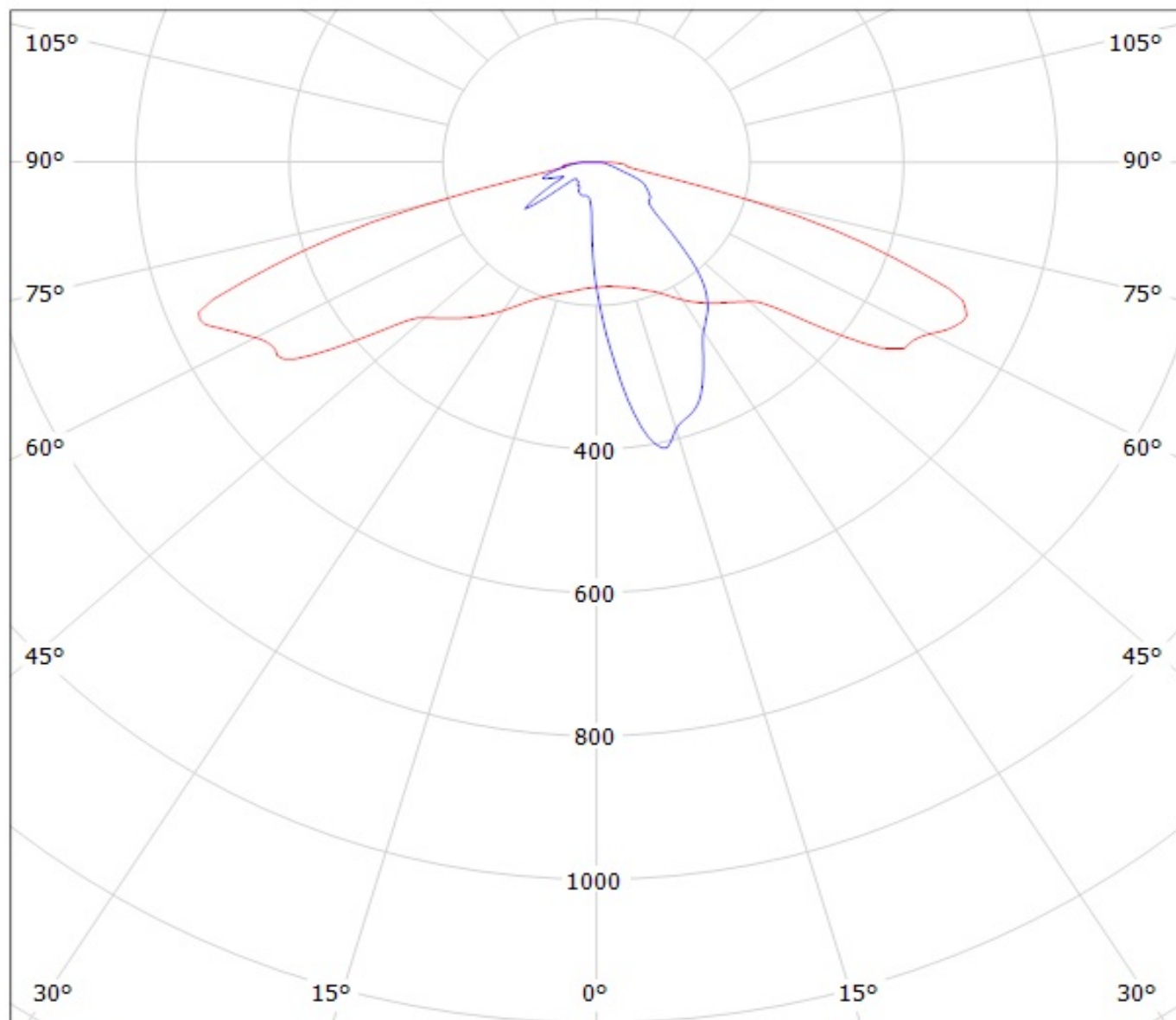

cd/klm

— C0 - C180

— C90 - C270



Luminaire: LEDiL Oy C13300\_STRADA-2X2-T2\_(LUXEON\_MZ) Eff.94.0%

Lamps: 1 x LUXEON\_MZ\_2x2\_(LMZ7-QW57)\_417.25lm@250mA\_P=2.71916W\_CCT=5700K\_I=249.9mA

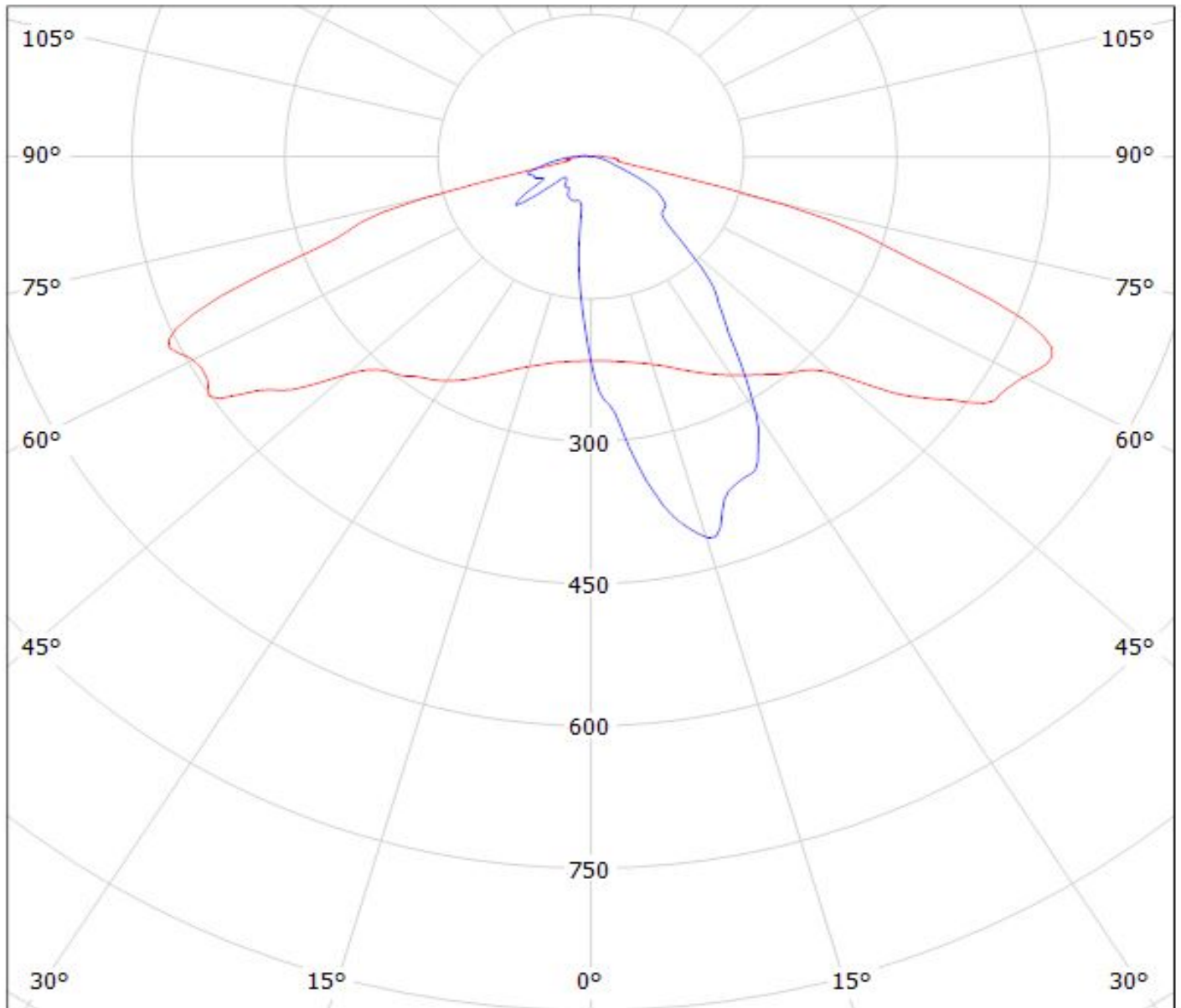

cd/klm

— C0 - C180

— C90 - C270

$\eta = 94\%$

Luminaire: LEDiL Oy C13300\_STRADA-2X2-T2\_(Luxeon\_TX)

Lamps: 1 x Luxeon\_TX\_2x2\_321.384lm@250mA\_P=2.79488W\_I=249.9mA

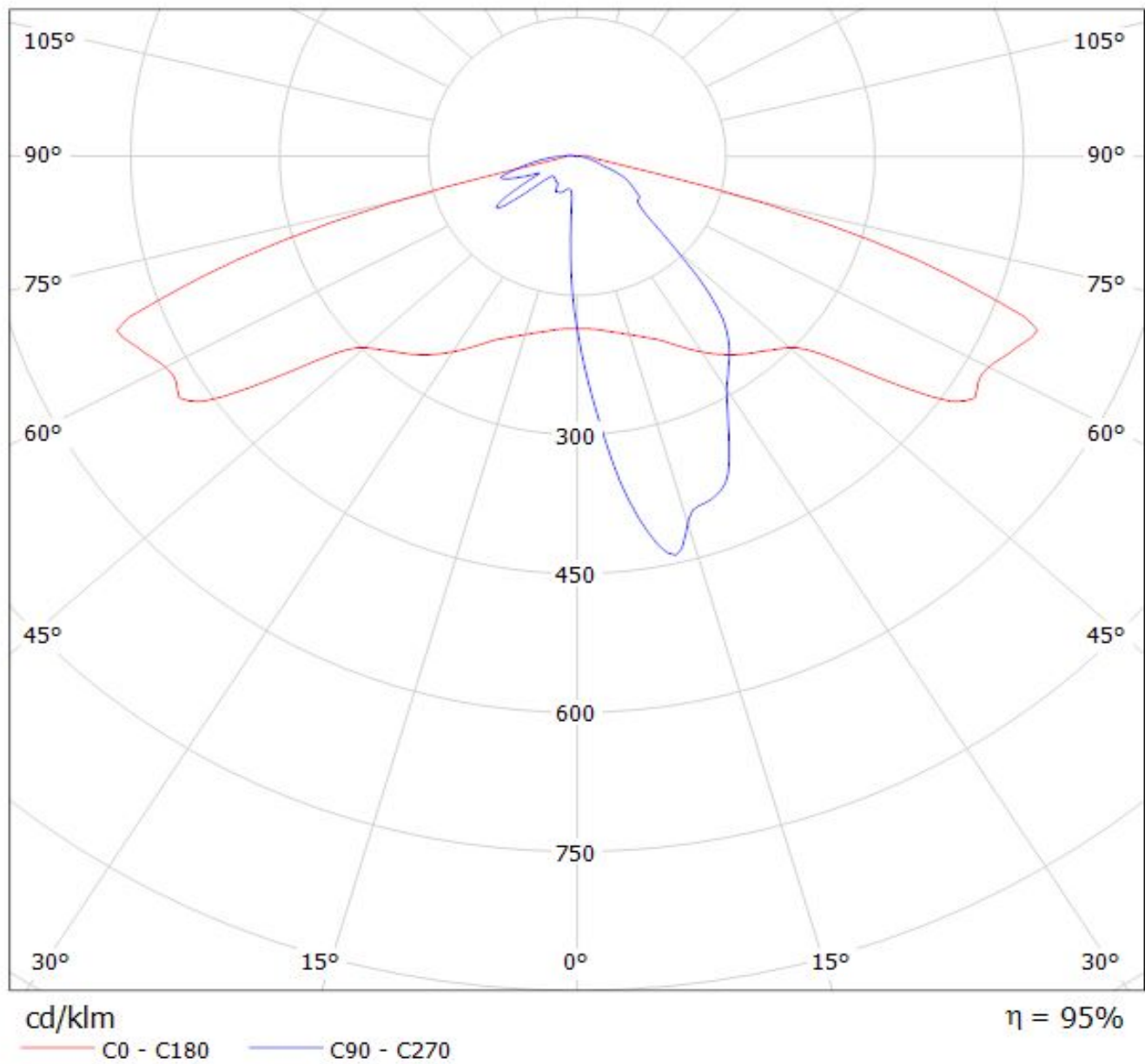

Luminaire: LEDiL Oy C13300\_STRADA-2X2-T2\_(Luxeon\_5050)

Lamps: 1 x Luxeon\_5050\_2x2\_1270.76lm@80mA\_CCT=5700K\_P=7.35815W\_I=0.080A\_70CRI

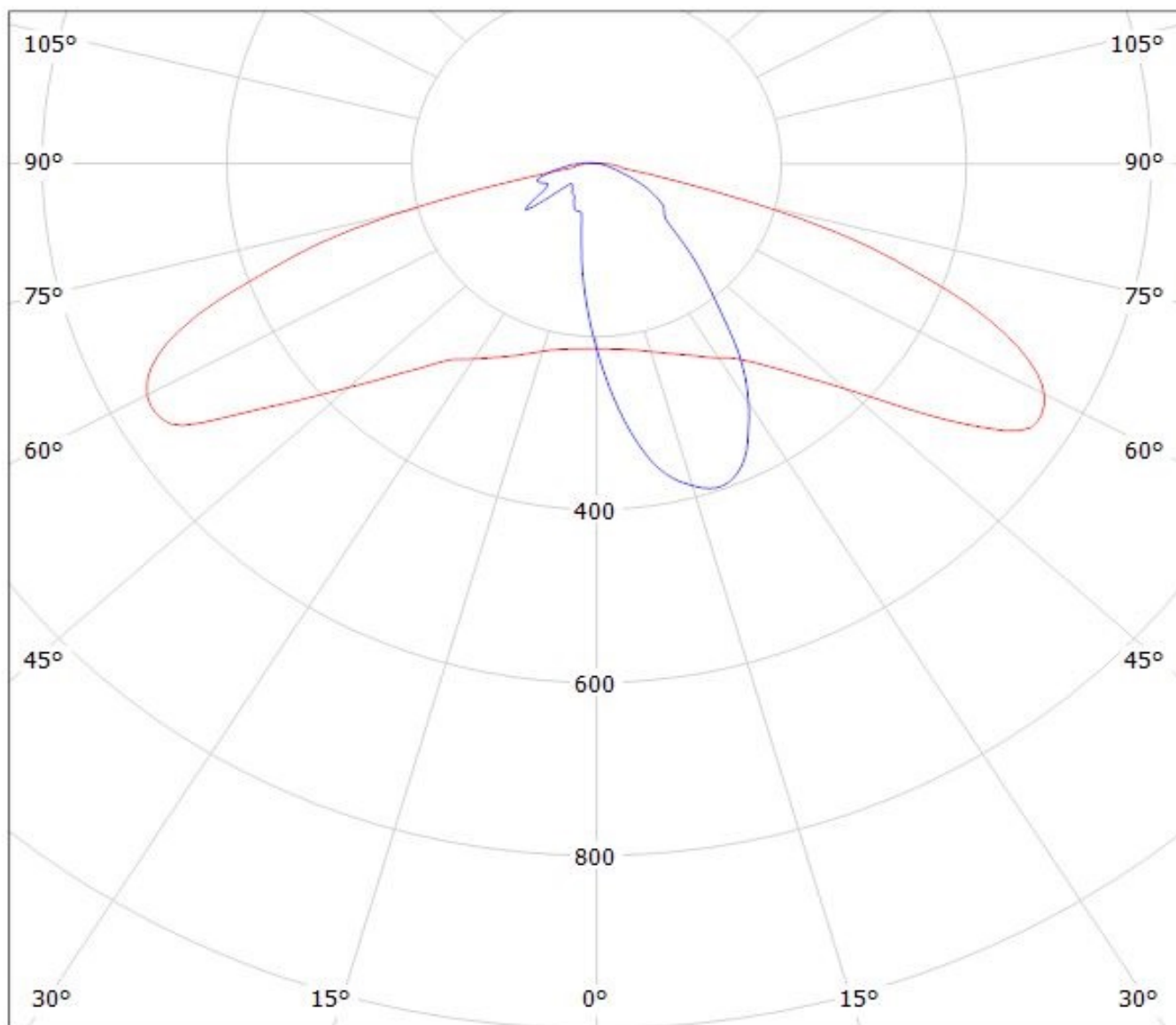

cd/klm

$\eta = 94\%$

— C0 - C180

— C90 - C270

**LEDiL Oy C13300\_STRADA-2x2-T2\_(NICHIA\_NS9x383) Eff.95.4% / LDC  
(Polar)**

Luminaire: LEDiL Oy C13300\_STRADA-2x2-T2\_(NICHIA\_NS9x383) Eff.95.4%  
Lamps: 1 x NICHIA\_NS9x383 (287.074lm@250mA)

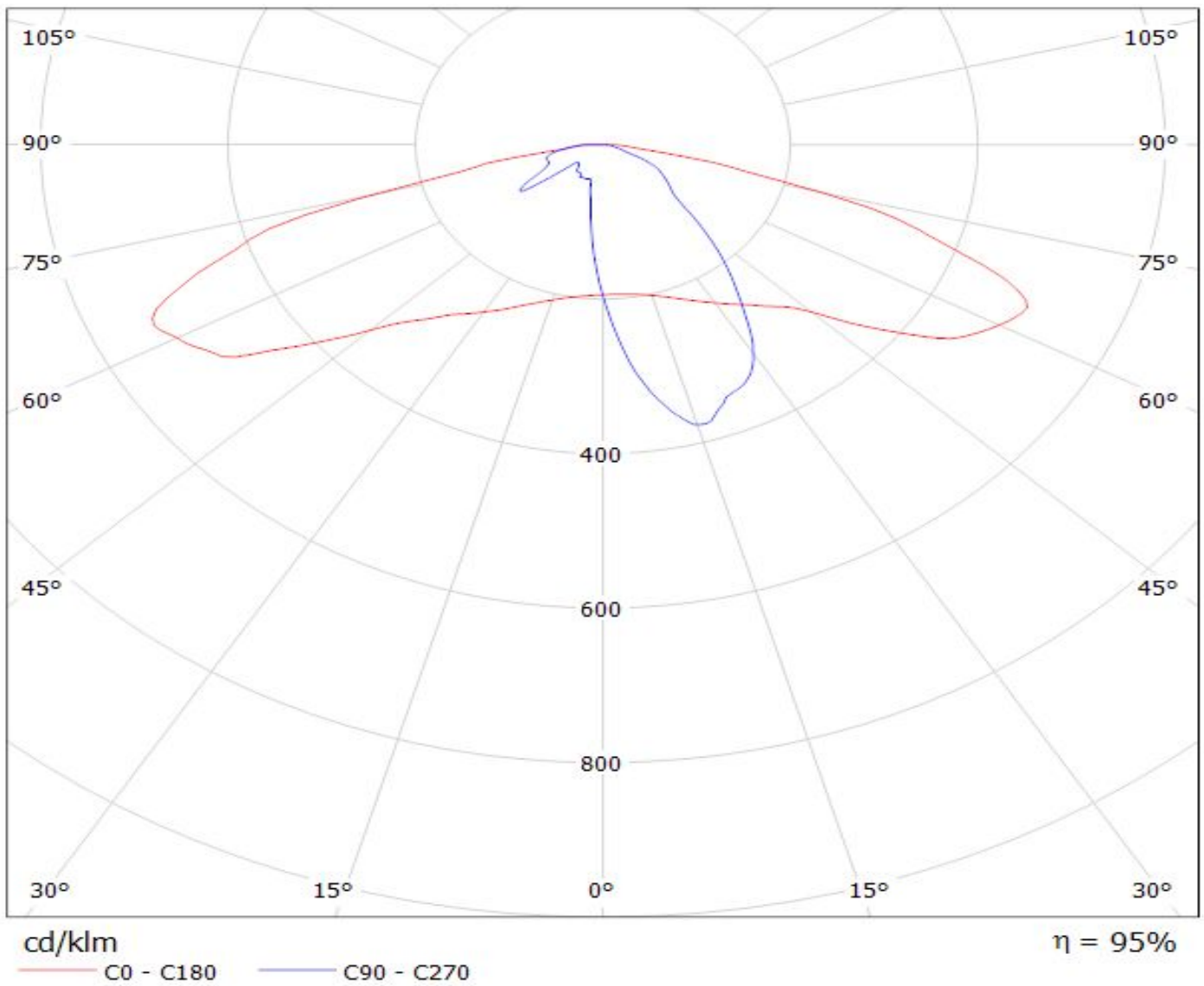

Luminaire: LEDiL Oy C13300\_STRADA-2X2-T2\_(NWSL229AE)

Lamps: 1 x Nichia\_2X2\_NWSL229AE\_476.548lm@250mA\_P=2.7515W\_I=0.250A

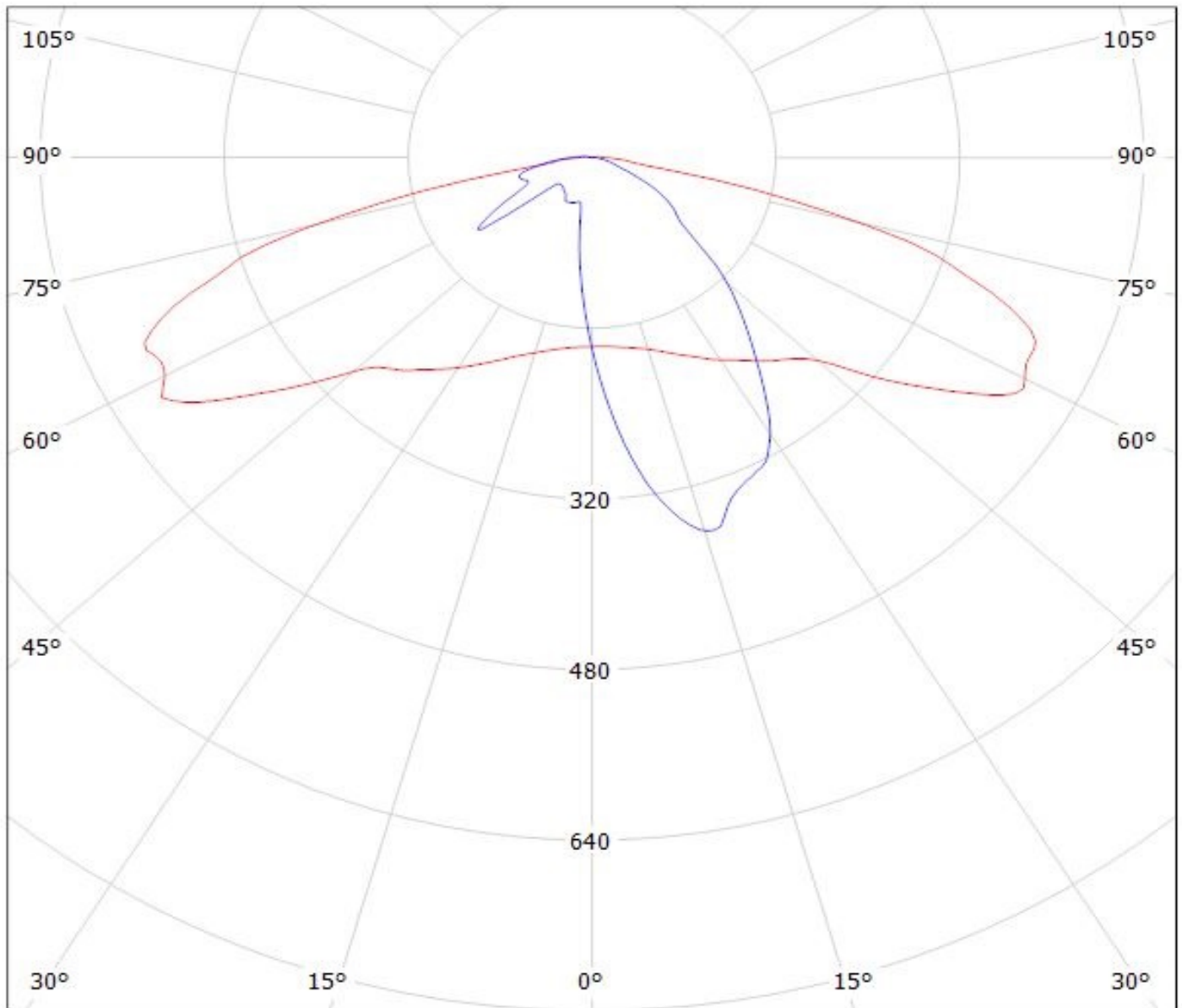

cd/klm

— C0 - C180

— C90 - C270

$\eta = 94\%$

Luminaire: Ledil C13300\_STRADA-2X2-T2\_(NVSW319AE)  
Lamps: 1 x Nichia\_NVSW319AE\_(sm405D440f2L2R70)

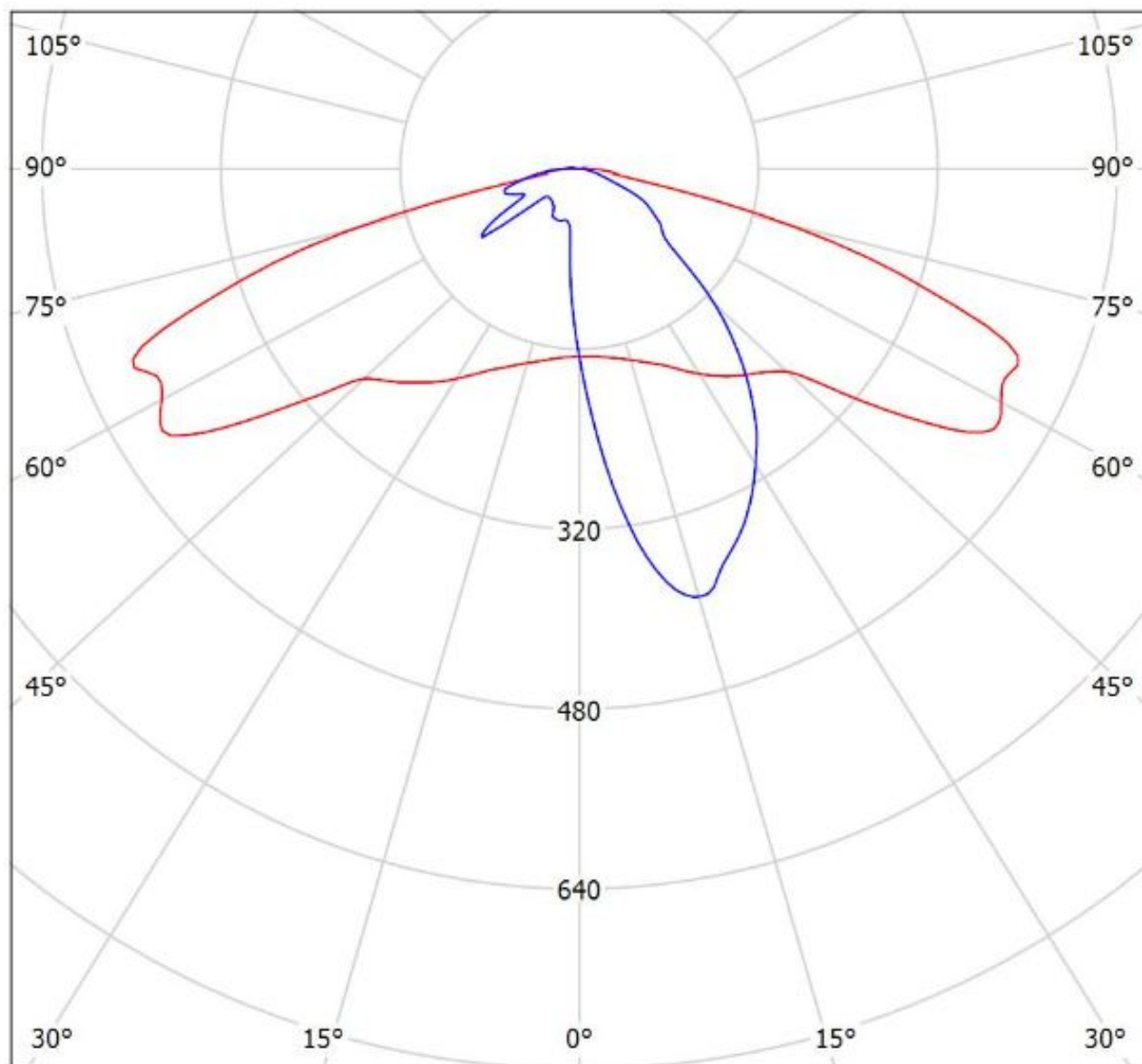

cd/klm

— C0 - C180 — C90 - C270

$\eta = 96\%$

Luminaire: LEDiL Oy C13300\_STRADA-2X2-T2\_(E21A)  
Lamps: 1 x Nichia\_E21A\_452.248lm@250mA\_2.805W\_I=0.250A

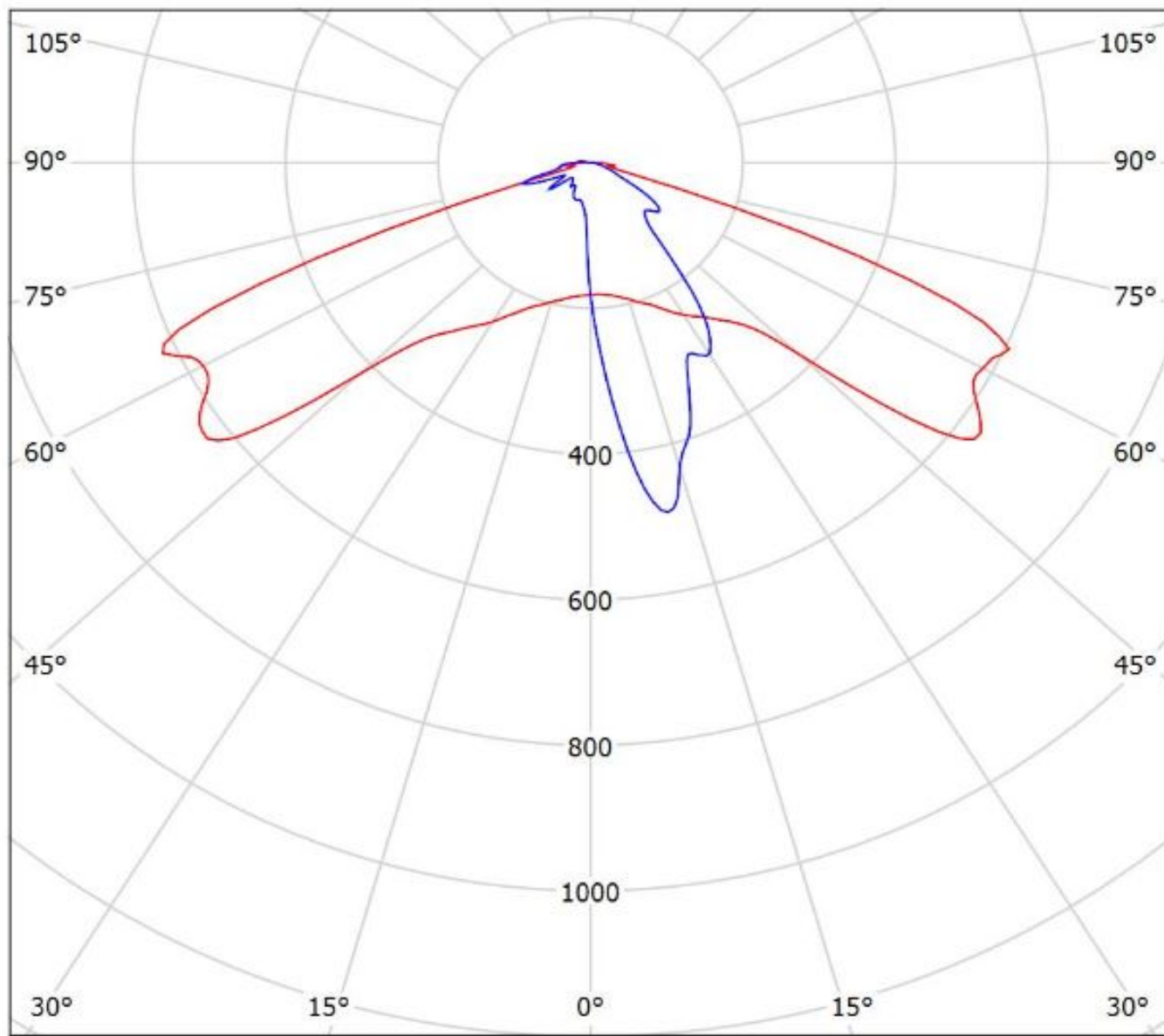

cd/klm

— C0 - C180 — C90 - C270

$\eta = 95\%$

Luminaire: LEDiL Oy C13300\_STRADA-2X2-T2 Eff.94.4%  
Lamps: 1 x Osram Square PC (399lm@250mA)

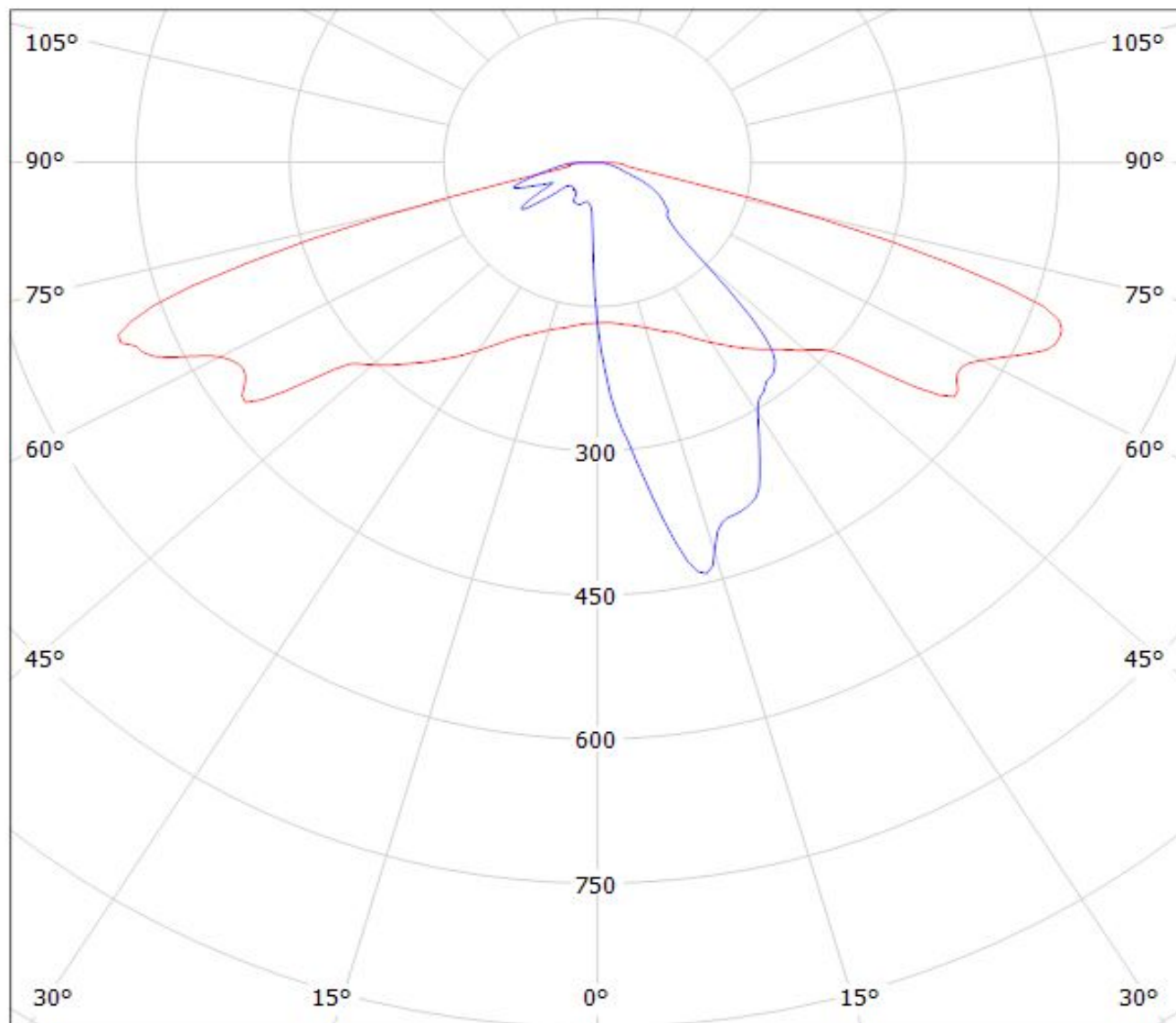

cd/klm

— C0 - C180

— C90 - C270

$\eta = 94\%$



Luminaire: Ledil C13300\_STRADA-2x2-T2\_(square\_gen3)

Lamps: 1 x Oslon\_square\_gen3\_2x2\_(GW\_CSSRM2.PM)\_460.271lm@250mA\_CCT=5000K\_P=2.80625W\_I=0.25A

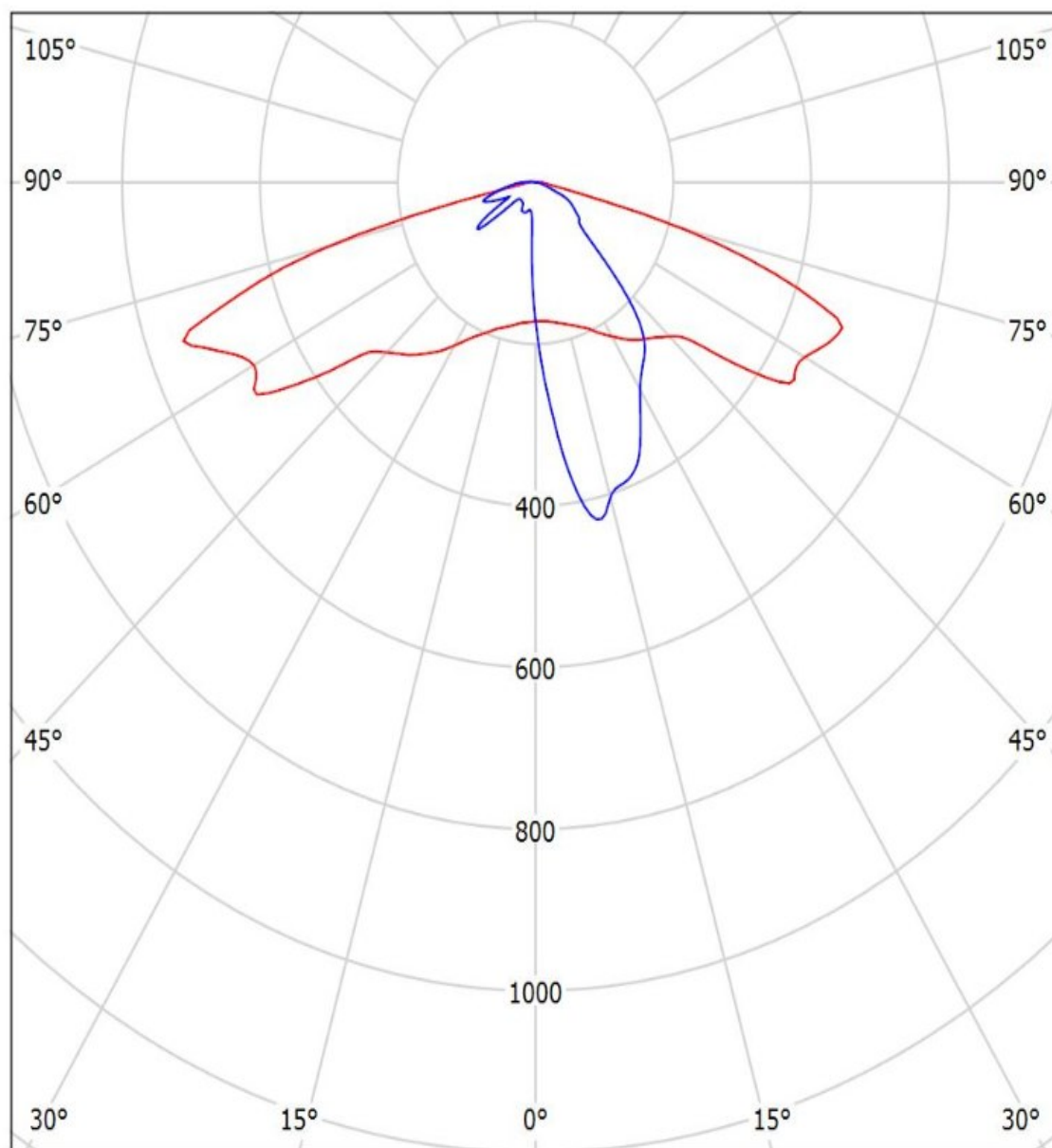

cd/klm

— C0 - C180 — C90 - C270

$\eta = 95\%$

Luminaire: Ledil Oy C13300\_STRADA-2X2-T2\_(Duris\_P8)\_SIMULATED  
Lamps: 1 x Osram Duris P8

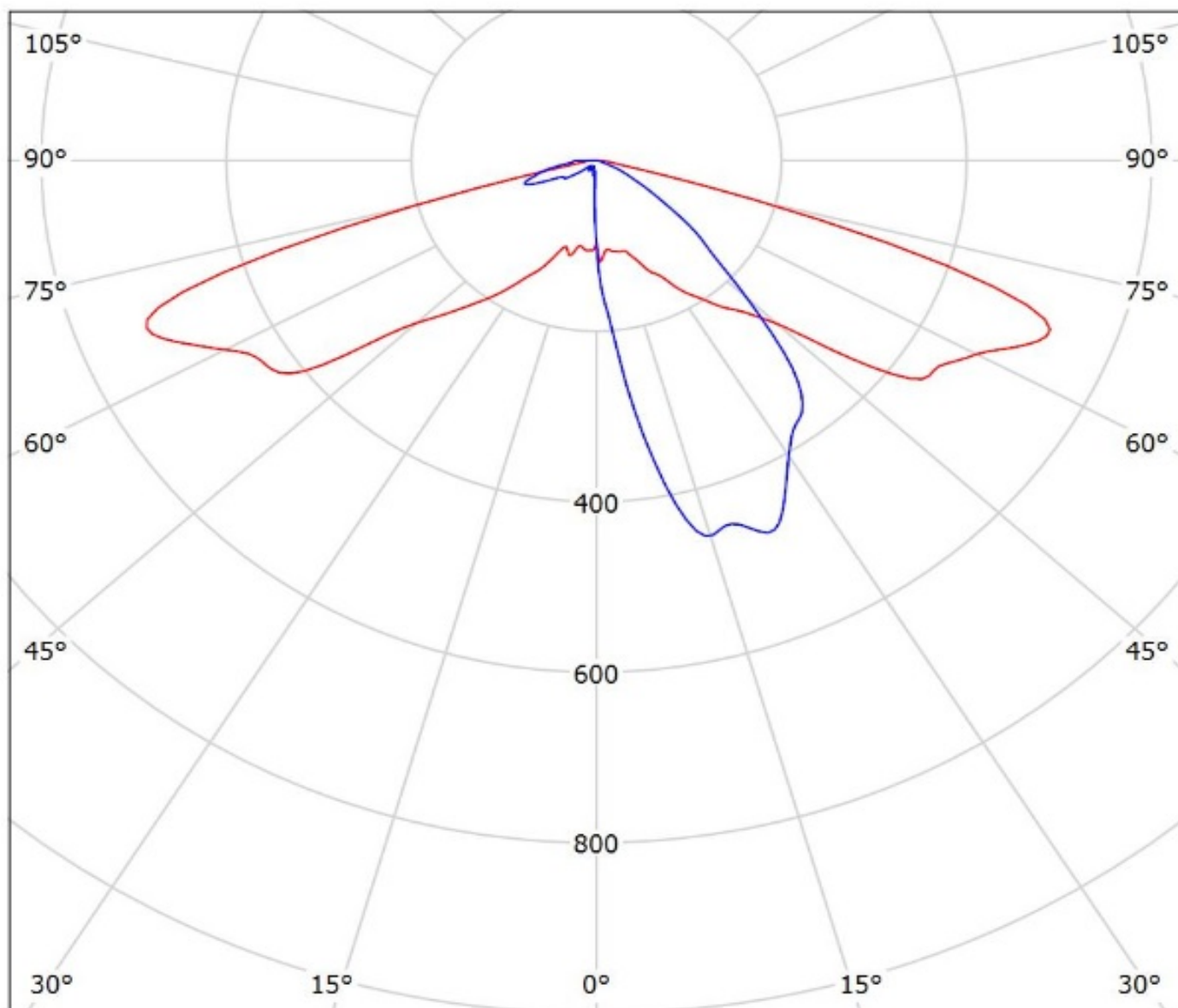

cd/klm

— C0 - C180 — C90 - C270

$\eta = 92\%$

Luminaire: LEDiL Oy C13300\_STRADA-2X2-T2\_(Fortimo\_F-Flex\_2x8\_740DAG3)

Lamps: 1 x Philips\_Fortimo\_F-Flex\_2x8\_740DAG3\_1786.86lm@250mA\_P=11.6092W\_I=0.2498A

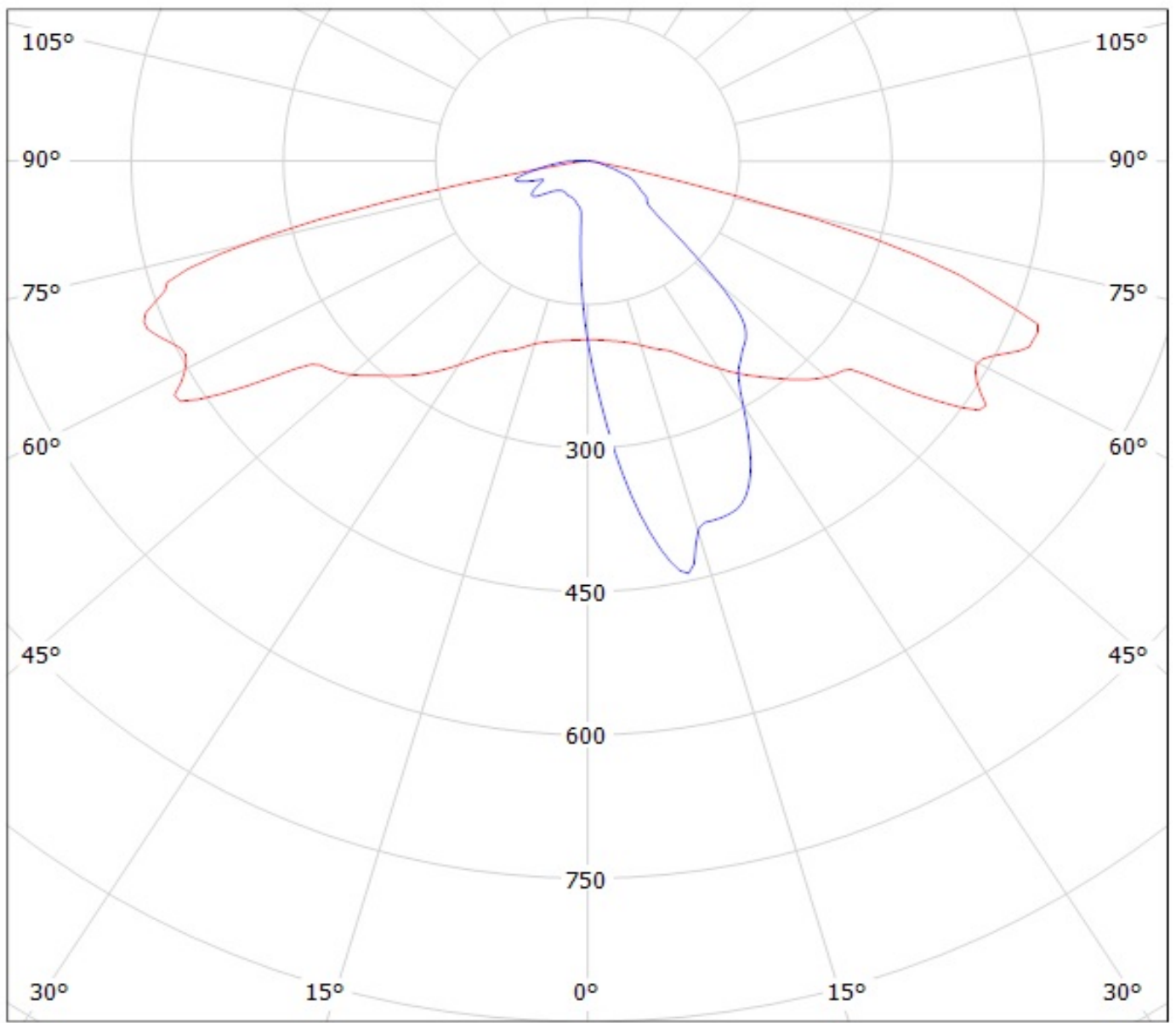

cd/klm

— C0 - C180

— C90 - C270

$\eta = 95\%$

Luminaire: LEDiL Oy C13300\_STRADA-2X2-T2\_(LH351B)

Lamps: 1 x SAMSUNG\_LH351B\_2x2\_440.73lm@250mA\_P=2.84311W\_I=249.9mA

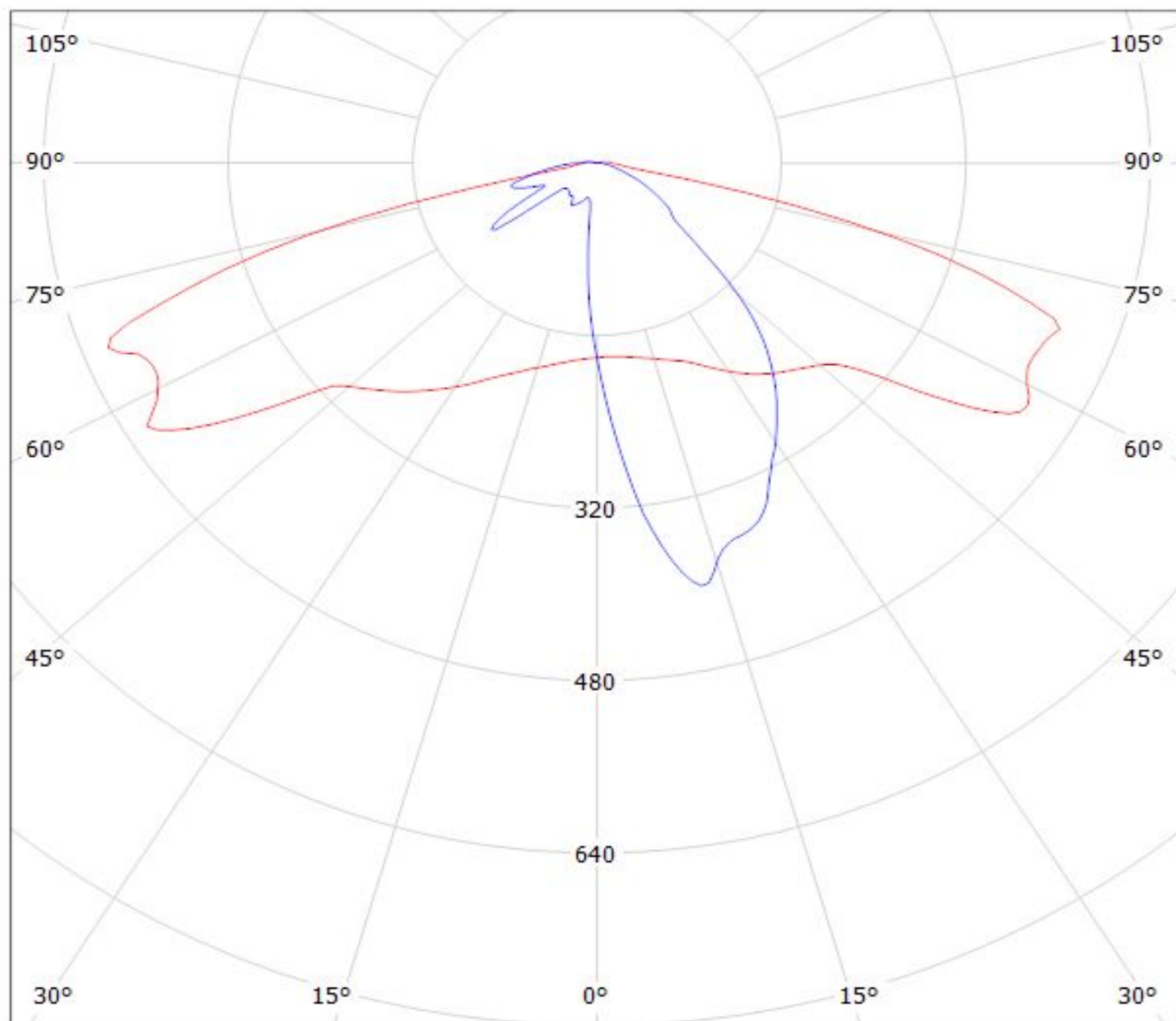

cd/klm

— C0 - C180

— C90 - C270

$\eta = 94\%$

Luminaire: LEDiL Oy C13300\_STRADA-2X2-T2\_(LH351Z)

Lamps: 1 x SAMSUNG\_LH351Z\_2x2\_365.89lm@250mA\_P=2.86371W\_I=249.8mA

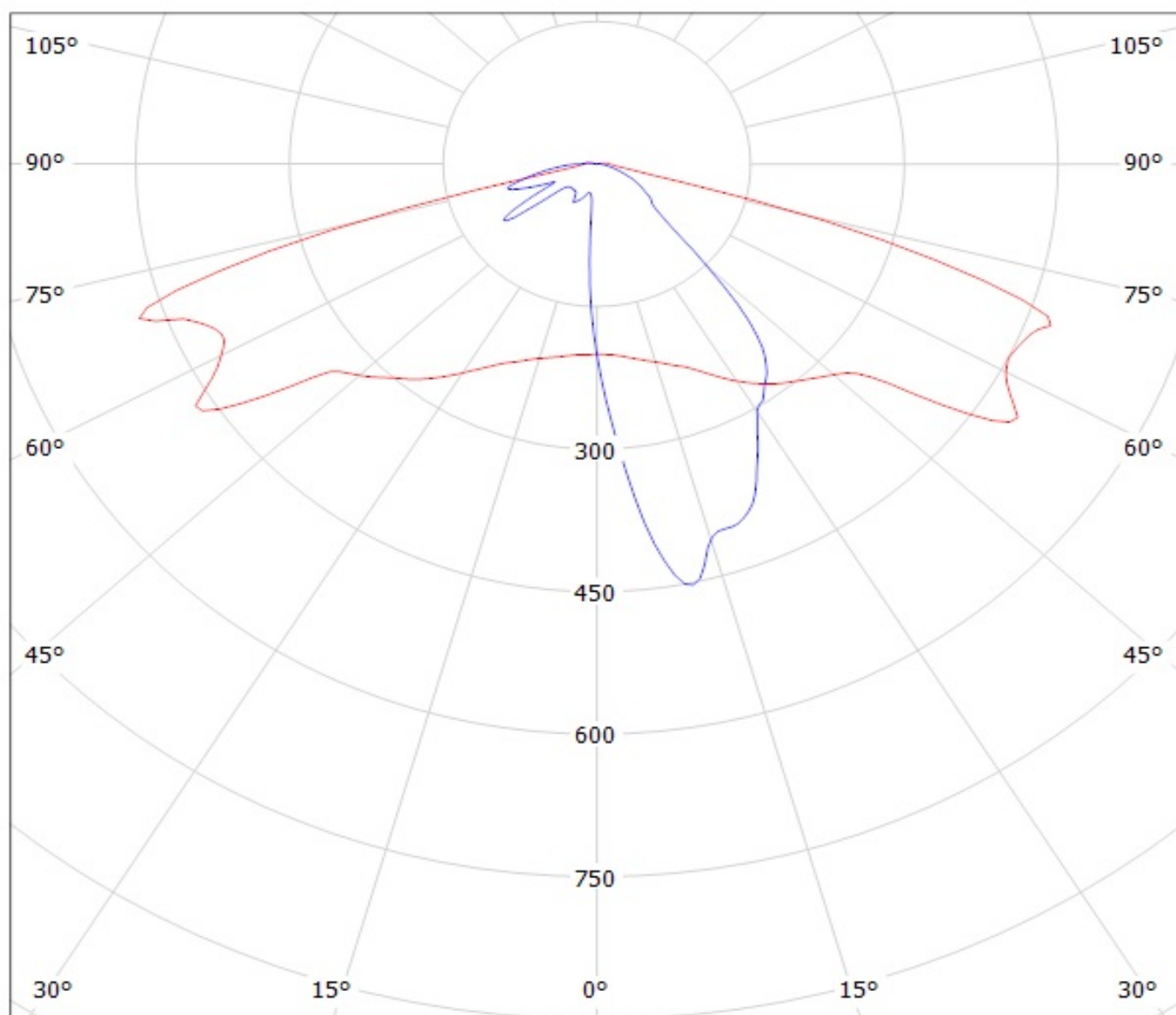

cd/klm

— C0 - C180

— C90 - C270

$\eta = 94\%$

Luminaire: LEDiL Oy C13300\_STRADA-2X2-T2\_(LH351D)

Lamps: 1 x Samsung\_LH351D\_524.264lm@250mA\_P=2.7523W\_I=0.250A

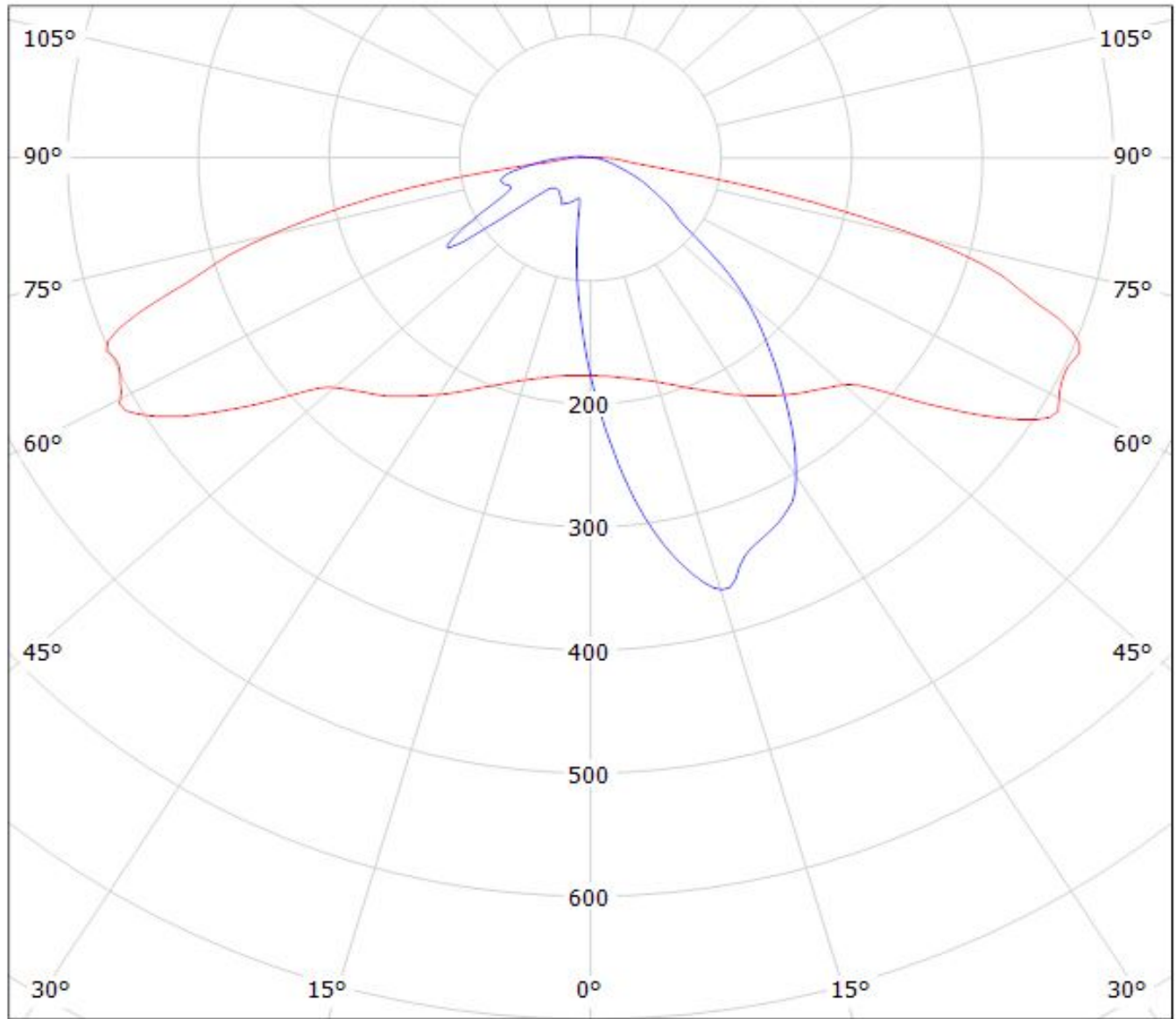

cd/klm

— C0 - C180

— C90 - C270

$\eta = 95\%$

Luminaire: LEDiL Oy C13300\_STRADA-2x2-T2\_(MJT4040) Eff. 94%  
Lamps: 1 x SEOUL ACRICH MJT4040 (SAW09H0A) 255lm@40mA P=2.37W I=40mA

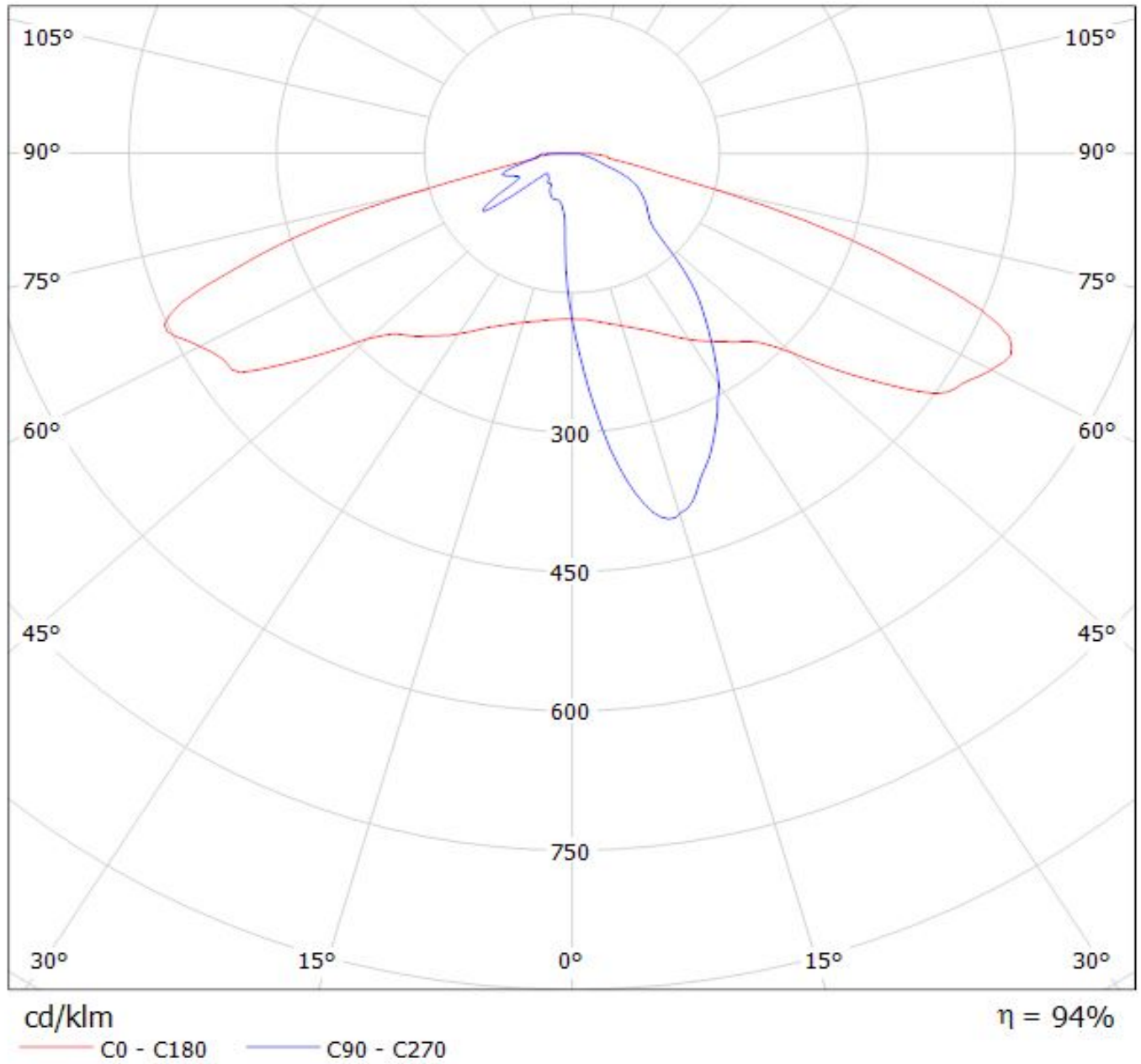

Luminaire: LEDil Oy C13300\_STRADA-2X2-T2\_(Z5M1) Efficiency=94%  
Lamps: 1 x Seoul Z5M1 (SZ5-M1-WN-C8) 379lm @ 250mA CCT=4600K P=2.9W I=250mA

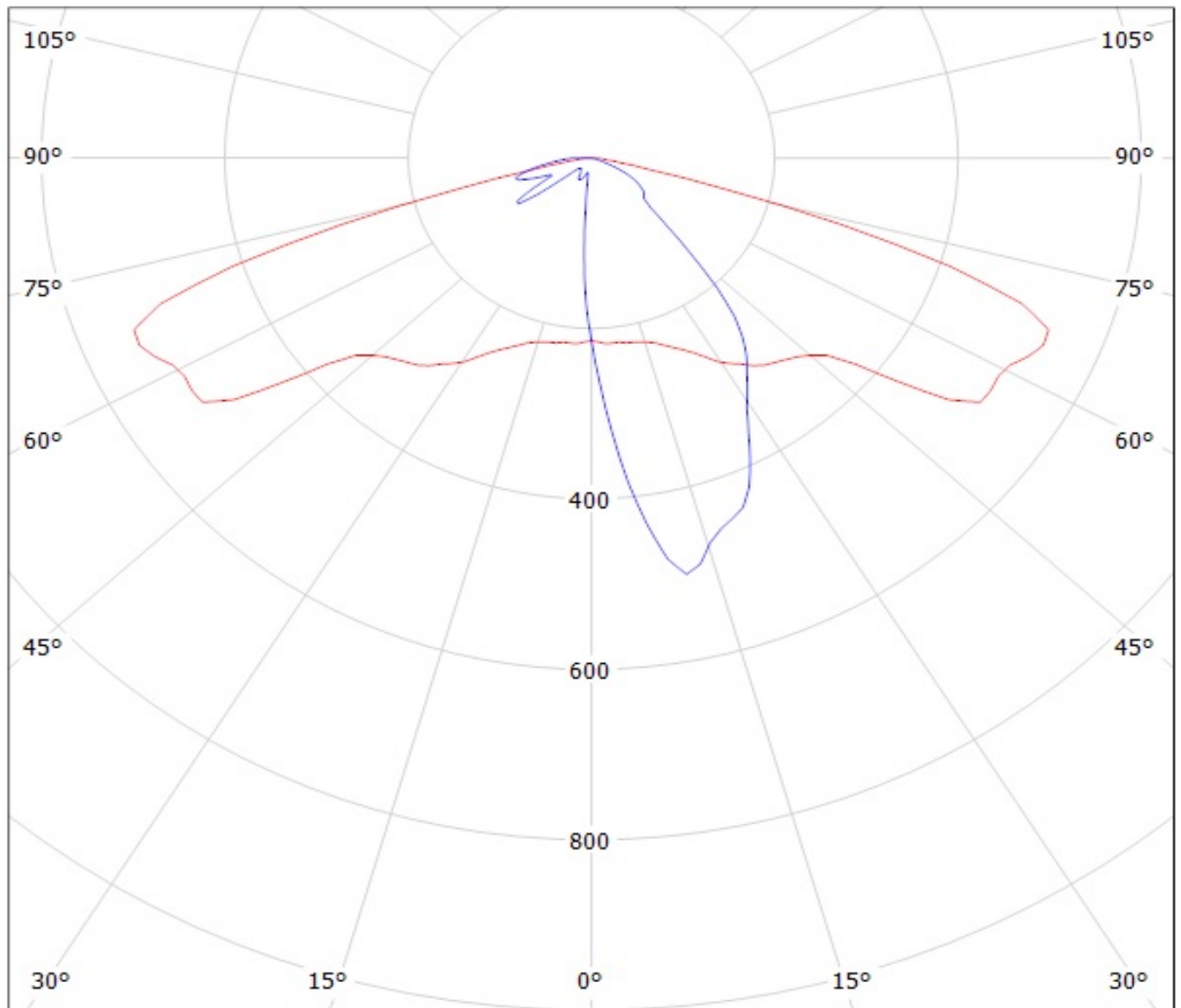

cd/klm

— C0 - C180    — C90 - C270



Luminaire: Ledil C13300\_STRADA-2X2-T2\_(Z8Y22plus)

Lamps: 1 x Seoul\_Z8Y22plus\_(W6E2G)\_513.996lm@250mA\_P=2.754W\_I=0.250A

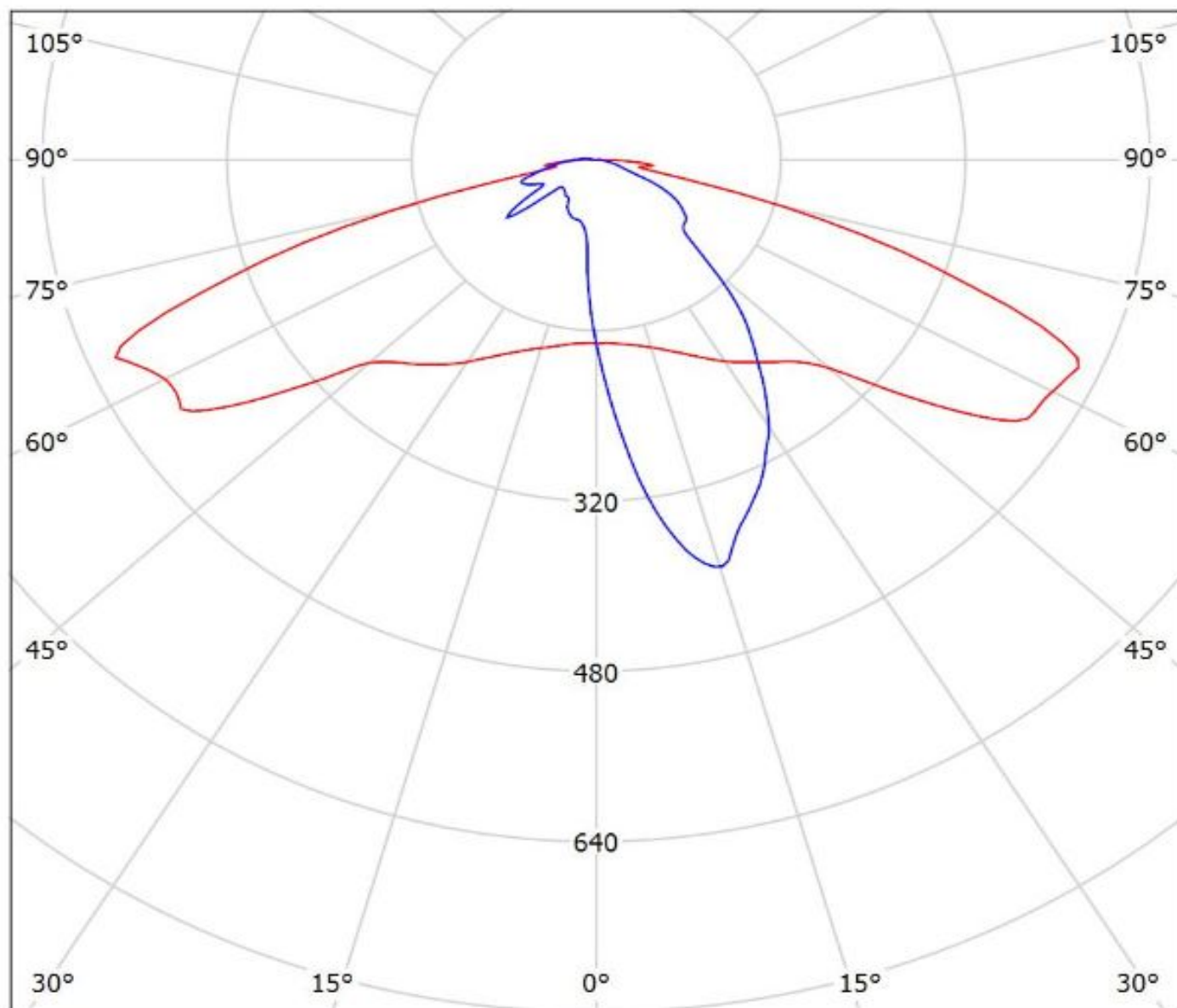

cd/klm

— C0 - C180 — C90 - C270

$\eta = 97\%$

# Ledil C13300\_STRADA-2X2-T2\_(TL1L3) / LDC (Polar)

Luminaire: Ledil C13300\_STRADA-2X2-T2\_(TL1L3)

Lamps: 1 x Toshiba\_TL1L3\_2x2\_(TL1L3-NW1.L)\_387.773lm@250mA\_CCT=5000K\_P=2.829W\_I=0.25A

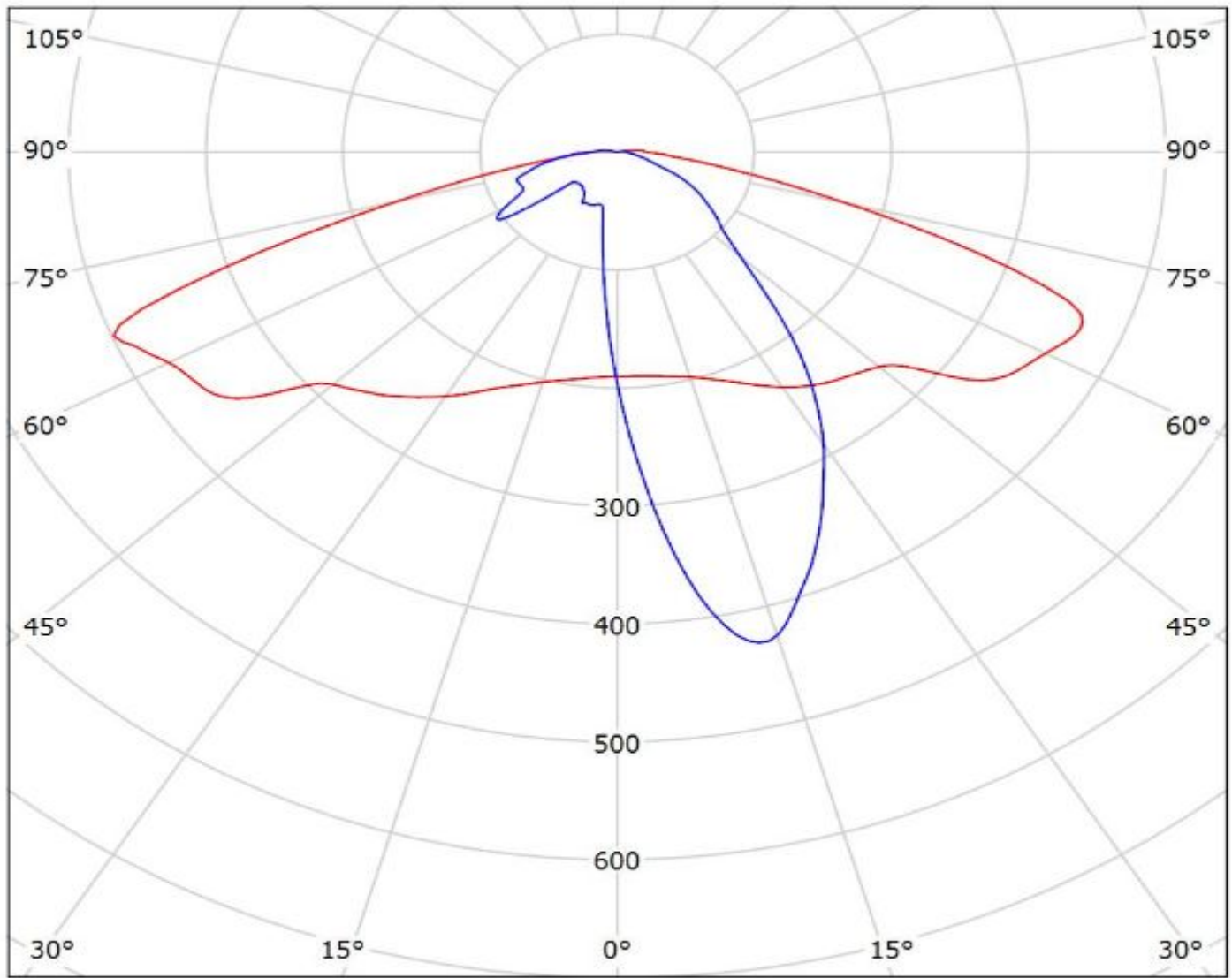

cd/klm

— C0 - C180 — C90 - C270

$\eta = 95\%$

# Ledil C13300\_STRADA-2X2-T2\_(TL1L4) / LDC (Polar)

Luminaire: Ledil C13300\_STRADA-2X2-T2\_(TL1L4)

Lamps: 1 x Toshiba\_TL1L4\_2x2\_(TL1L4-DW0)\_472.639lm@250mA\_CCT=6500K\_P=2.9W\_l=0.25A

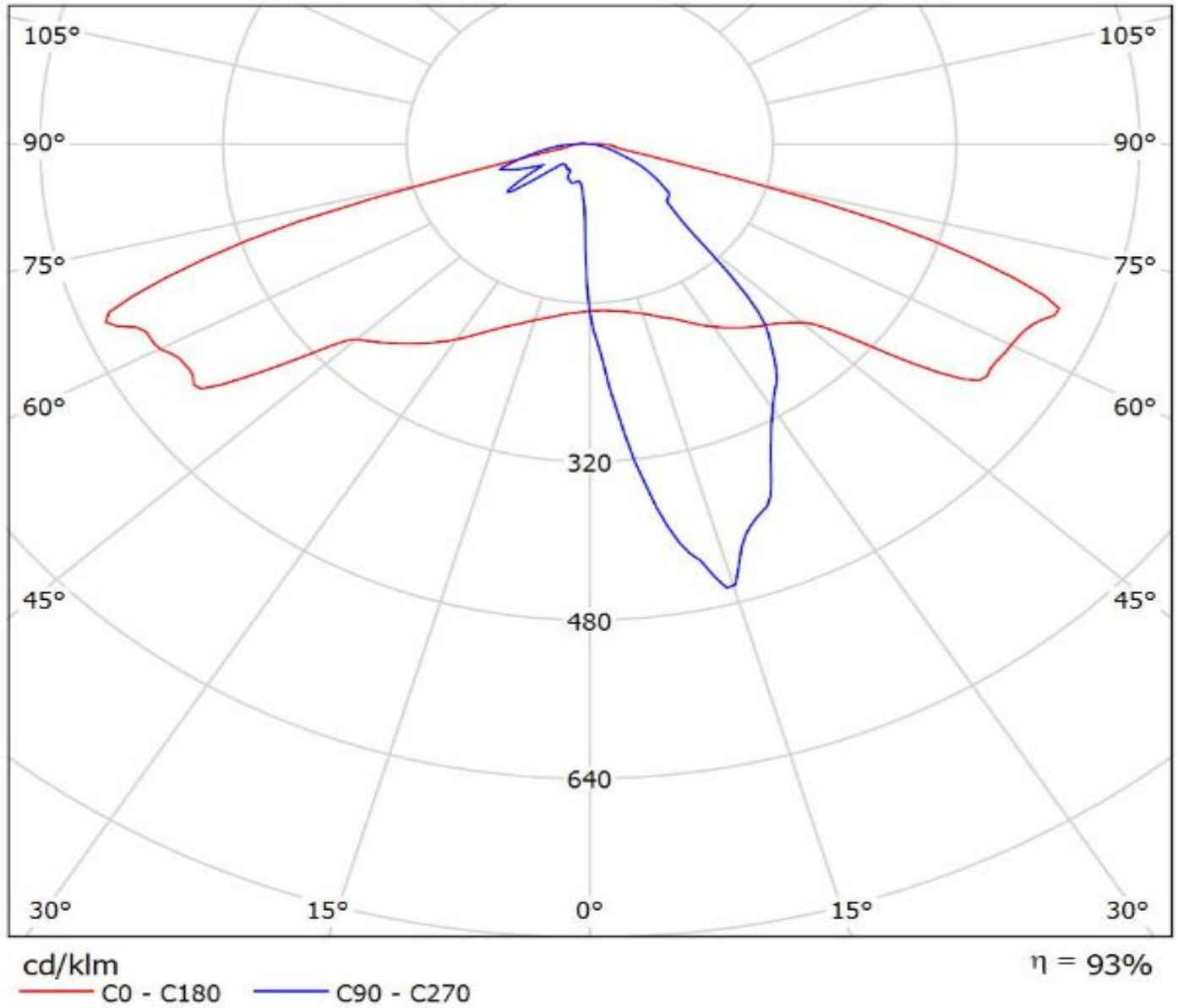

Luminaire: LEDiL Oy C13300\_STRADA-2X2-T2(Tridonic\_Module\_RLE\_G1)

Lamps: 1 x Tridonic\_Module\_RLE\_G1\_4576.03lm@700mA\_P=32.0681W\_η=0.700A

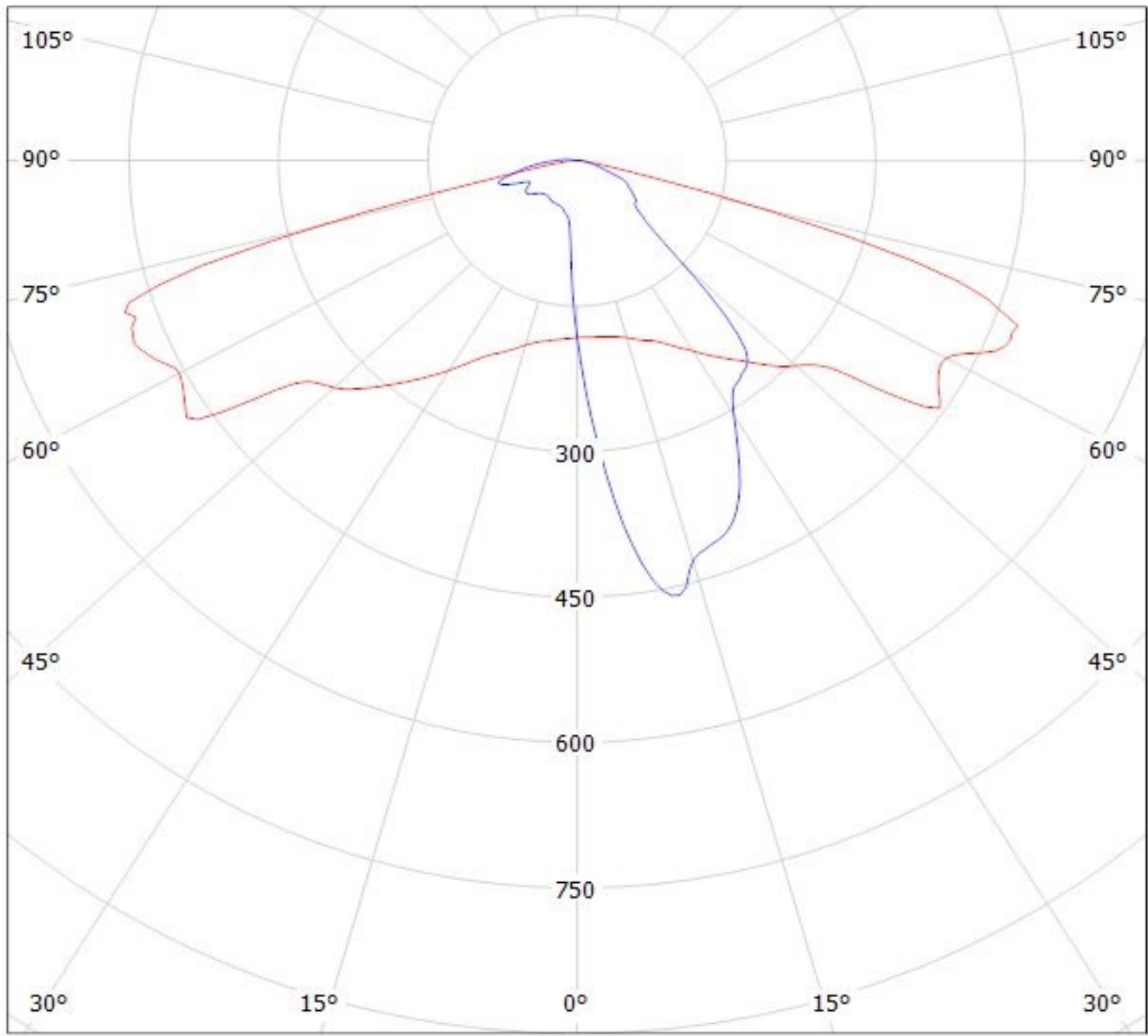

cd/klm

η = 94%

— C0 - C180    — C90 - C270

Luminaire: LEDiL Oy C13300\_STRADA-2X2-T2(Tridonic\_Module\_RLE\_G1)

Lamps: 1 x Tridonic\_Module\_RLE\_G1\_4576.03lm@700mA\_P=32.0681W\_η=0.700A

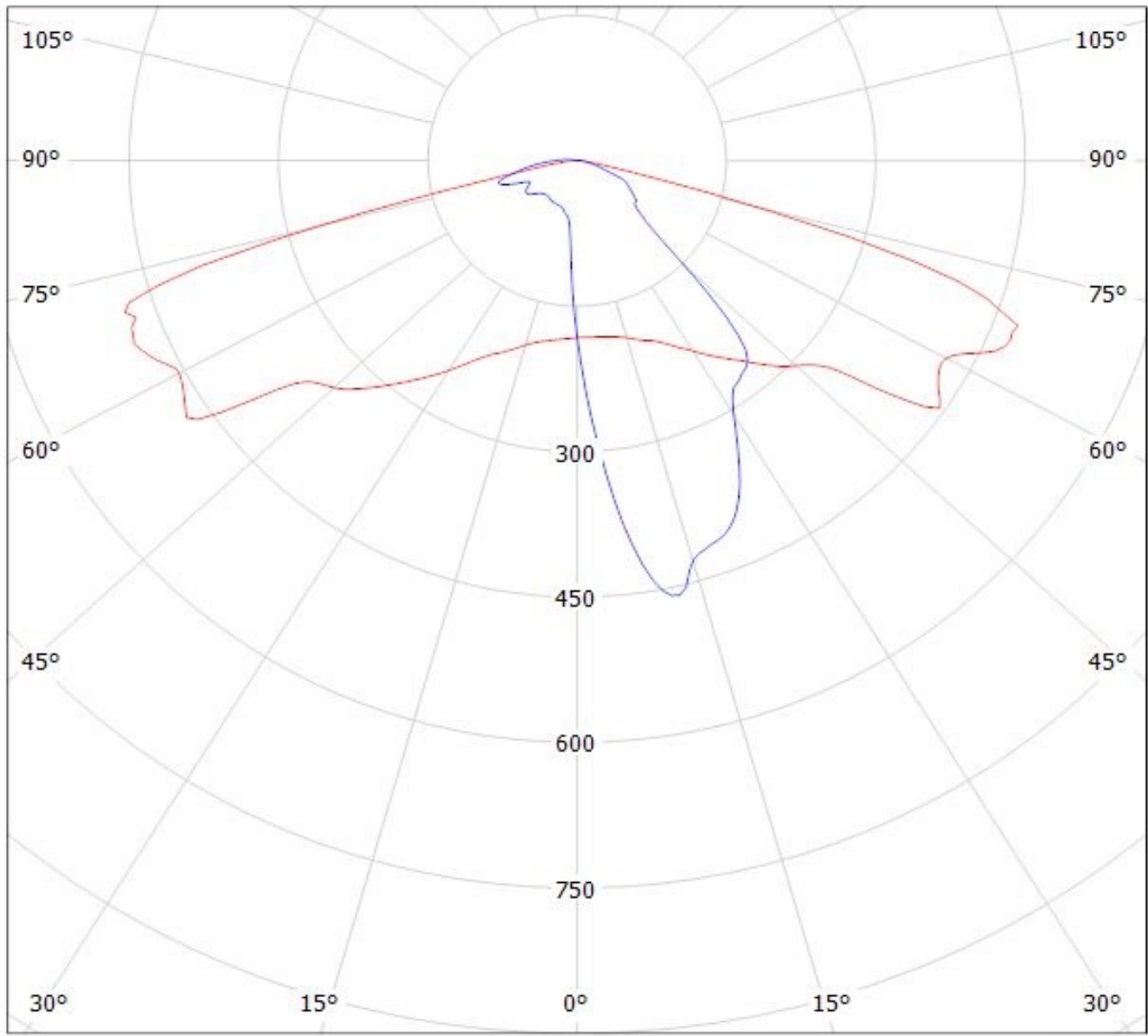

cd/klm

$\eta = 94\%$

— C0 - C180    — C90 - C270

Luminaire: LEDiL Oy C13300\_STRADA-2X2-T2(Tridonic\_Module\_RLE\_G1)  
Lamps: 1 x Tridonic\_Module\_RLE\_G1\_2288lm@700mA\_P=16W\_I=0.700A

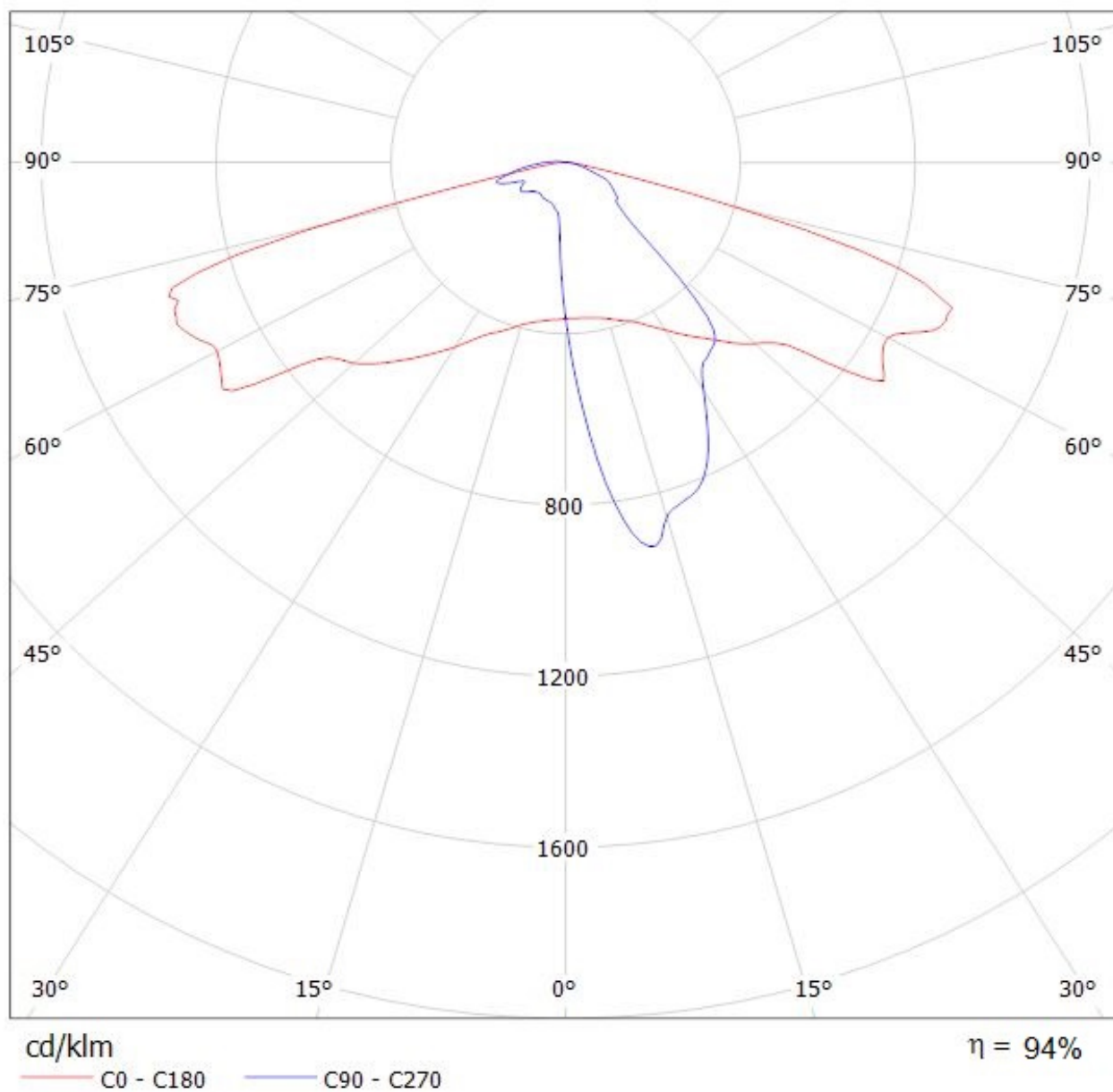

Luminaire: LEDiL Oy C13300\_STRADA-2X2-T2(Tridonic\_Module\_RLE\_G1)  
Lamps: 1 x Tridonic\_Module\_RLE\_G1\_2288lm@700mA\_P=16W\_I=0.700A

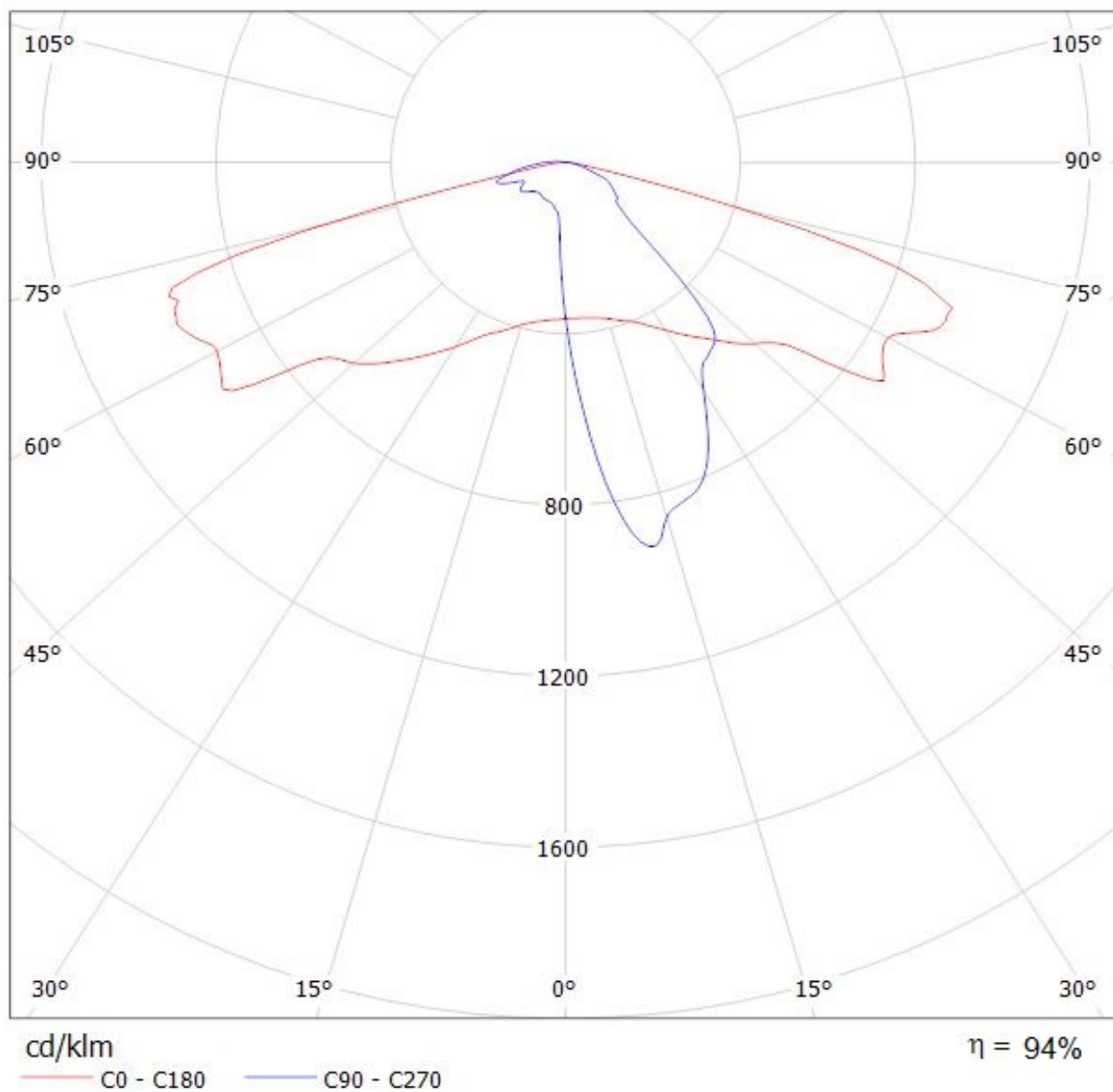

**NOTE: The typical divergence will be changed by different color, chip size and chip position tolerance. The typical total divergence is the full angle measured where the luminous intensity is half of the peak value.**