

Features

N-Ch:

- $V_{DS} (V) = 55V$
- $R_{DS(ON)} < 50m\Omega$ ($V_{GS} = 10V$)
- $R_{DS(ON)} < 65m\Omega$ ($V_{GS} = 4.5V$)

P-Ch:

- $V_{DS} (V) = -55V$
- $R_{DS(ON)} < 90m\Omega$ ($V_{GS} = 10V$)
- $R_{DS(ON)} < 100m\Omega$ ($V_{GS} = 4.5V$)
- Generation V Technology
- Ultra Low On-Resistance
- Surface Mount
- Fully Avalanche Rated
- Lead-Free

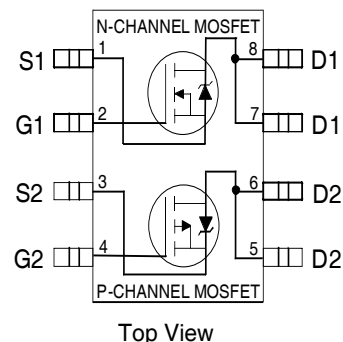

Description

The SOP-8 has been modified through a customized leadframe for enhanced thermal characteristics and multiple-die capability making it ideal in a variety of power applications. With these improvements, multiple devices can be used in an application with dramatically reduced board space. The package is designed for vapor phase, infra red, or wave soldering techniques.

Absolute Maximum Ratings

	Parameter	Max.		Units
		N-Channel	P-Channel	
V_{DS}	Drain-Source Voltage	55	-55	V
$I_D @ T_A = 25^\circ C$	Continuous Drain Current, $V_{GS} @ 10V$	4.7	-3.4	A
$I_D @ T_A = 70^\circ C$	Continuous Drain Current, $V_{GS} @ 10V$	3.8	-2.7	
I_{DM}	Pulsed Drain Current ①	38	-27	
$P_D @ T_A = 25^\circ C$	Maximum Power Dissipation ⑤	2.0		W
$P_D @ T_A = 70^\circ C$	Maximum Power Dissipation ⑤	1.3		W
E_{AS}	Single Pulse Avalanche Energy ③	72	114	mJ
I_{AR}	Avalanche Current	4.7	-3.4	A
E_{AR}	Repetitive Avalanche Energy	0.20		mJ
V_{GS}	Gate-to-Source Voltage	± 20		V
dv/dt	Peak Diode Recovery dv/dt ②	5.0	-5.0	V/ns
T_J, T_{STG}	Junction and Storage Temperature Range	-55 to + 150		$^\circ C$

Thermal Resistance

	Parameter	Typ.	Max.	Units
$R_{\theta JA}$	Maximum Junction-to-Ambient ⑤		62.5	$^\circ C/W$

Electrical Characteristics @ T_J = 25°C (unless otherwise specified)

	Parameter		Min.	Typ.	Max.	Units	Conditions
V _{(BR)DSS}	Drain-to-Source Breakdown Voltage	N-Ch	55			V	V _{GS} = 0V, I _D = 250μA
		P-Ch	-55				V _{GS} = 0V, I _D = -250μA
ΔV _{(BR)DSS} /ΔT _J	Breakdown Voltage Temp. Coefficient	N-Ch	0.059			V/°C	Reference to 25°C, I _D = 1mA
		P-Ch	0.054				Reference to 25°C, I _D = -1mA
R _{DS(ON)}	Static Drain-to-Source On-Resistance	N-Ch	43	50		mΩ	V _{GS} = 10V, I _D = 4.7A ④
			56	65			V _{GS} = 4.5V, I _D = 3.8A ④
		P-Ch	70	90			V _{GS} = -10V, I _D = -3.4A ④
			95	100			V _{GS} = -4.5V, I _D = -2.7A ④
V _{GS(th)}	Gate Threshold Voltage	N-Ch	1.0			V	V _{DS} = V _{GS} , I _D = 250μA
		P-Ch	-1.0				V _{DS} = V _{GS} , I _D = -250μA
g _{fs}	Forward Transconductance	N-Ch	7.9			S	V _{DS} = 10V, I _D = 4.5A ④
		P-Ch	3.3				V _{DS} = -10V, I _D = -3.1A ④
I _{DSS}	Drain-to-Source Leakage Current	N-Ch		2.0		μA	V _{DS} = 55V, V _{GS} = 0V
					-2.0		
		P-Ch		25			V _{DS} = 55V, V _{GS} = 0V, T _J = 55°C
				-25			V _{DS} = -55V, V _{GS} = 0V, T _J = 55°C
I _{GSS}	Gate-to-Source Forward Leakage	N-P			±100	nA	V _{GS} = ±20V
Q _g	Total Gate Charge	N-Ch	24	36		nC	N-Channel
		P-Ch	26	38			I _D = 4.5A, V _{DS} = 44V, V _{GS} = 10V ④
Q _{gs}	Gate-to-Source Charge	N-Ch	2.3	3.4		nC	P-Channel
		P-Ch	3.0	4.5			
Q _{gd}	Gate-to-Drain ("Miller") Charge	N-Ch	7.0	10		nC	P-Channel
		P-Ch	8.4	13			
t _{d(on)}	Turn-On Delay Time	N-Ch	8.3	12		ns	N-Channel
		P-Ch	14	22			
t _r	Rise Time	N-Ch	10	15		ns	P-Channel
		P-Ch	10	15			
t _{d(off)}	Turn-Off Delay Time	N-Ch	32	48		ns	N-Channel
		P-Ch	43	64			
t _f	Fall Time	N-Ch	13	20		ns	P-Channel
		P-Ch	22	32			
C _{iss}	Input Capacitance	N-Ch	740			pF	N-Channel
		P-Ch	690				
C _{oss}	Output Capacitance	N-Ch	190			pF	P-Channel
		P-Ch	210				
C _{rss}	Reverse Transfer Capacitance	N-Ch	71			pF	P-Channel
		P-Ch	86				

Source-Drain Ratings and Characteristics

	Parameter		Min.	Typ.	Max.	Units	Conditions
I _S	Continuous Source Current (Body Diode)	N-Ch			2.0	A	
		P-Ch			-2.0		
I _{SM}	Pulsed Source Current (Body Diode) ①	N-Ch			38	A	
		P-Ch			-27		
V _{SD}	Diode Forward Voltage	N-Ch	0.70	1.2		V	T _J = 25°C, I _S = 2.0A, V _{GS} = 0V ③
		P-Ch	-0.80	-1.2			T _J = 25°C, I _S = -2.0A, V _{GS} = 0V ③
t _{rr}	Reverse Recovery Time	N-Ch	60	90		ns	N-Channel
		P-Ch	54	80			
Q _{rr}	Reverse Recovery Charge	N-Ch	120	170		nC	P-Channel
		P-Ch	85	130			

Notes:

- ① Repetitive rating; pulse width limited by max. junction temperature. (See fig. 22)
- ② N-Channel I_{SD} ≤ 4.7A, di/dt ≤ 220A/μs, V_{DD} ≤ V_{(BR)DSS}, T_J ≤ 150°C
P-Channel I_{SD} ≤ -3.4A, di/dt ≤ -150A/μs, V_{DD} ≤ V_{(BR)DSS}, T_J ≤ 150°C
- ③ N-Channel Starting T_J = 25°C, L = 6.5mH R_G = 25Ω, I_{AS} = 4.7A.
P-Channel Starting T_J = 25°C, L = 20mH R_G = 25Ω, I_{AS} = -3.4A.
- ④ Pulse width ≤ 300μs; duty cycle ≤ 2%.
- ⑤ Surface mounted on FR-4 board, t ≤ 10sec.

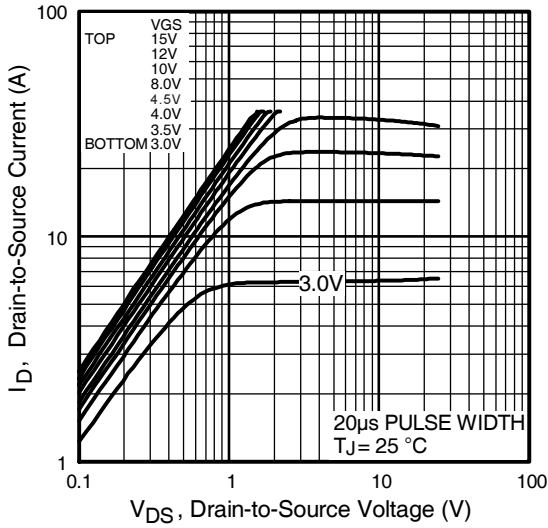

Fig 1. Typical Output Characteristics

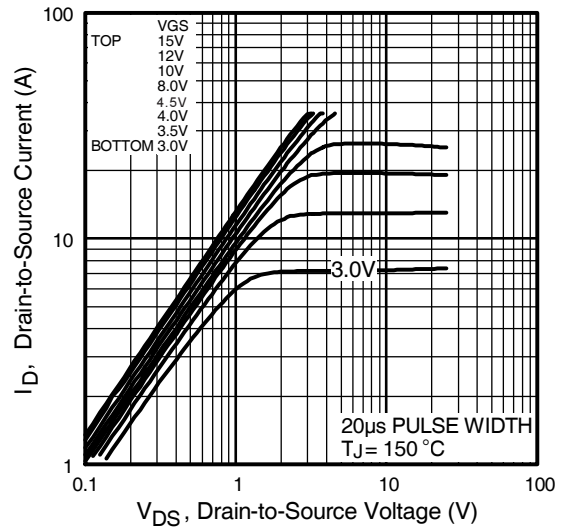

Fig 2. Typical Output Characteristics

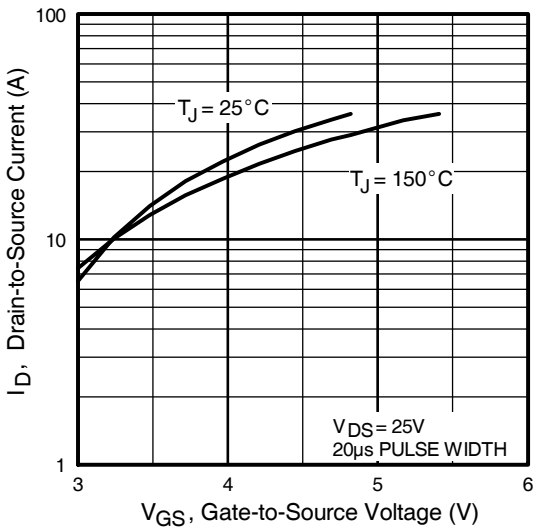

Fig 3. Typical Transfer Characteristics

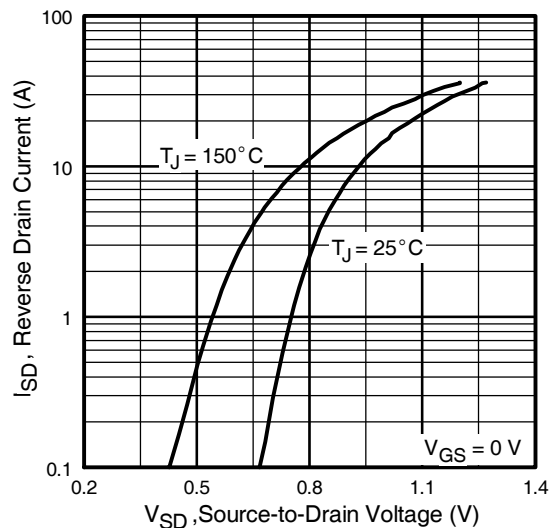

Fig 4. Typical Source-Drain Diode Forward Voltage

N-Channel

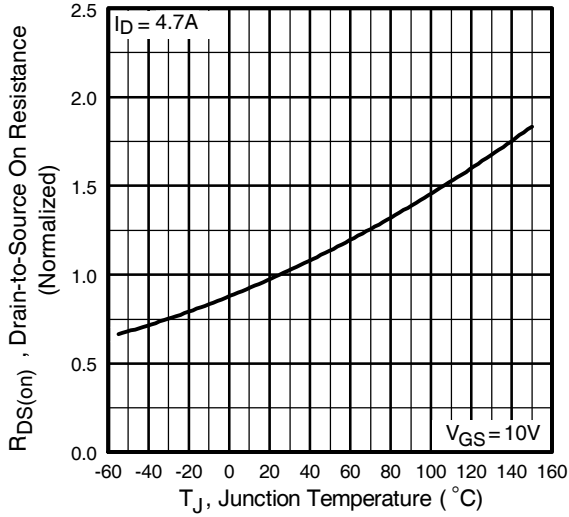

Fig 5. Normalized On-Resistance Vs. Temperature



Fig 6. Typical On-Resistance Vs. Drain Current

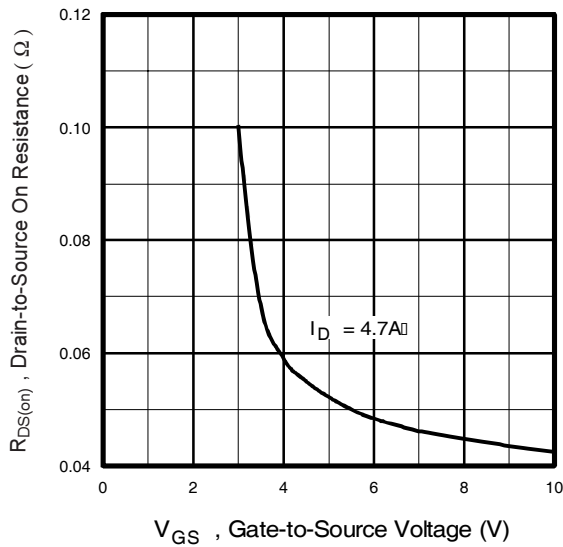

Fig 7. Typical On-Resistance Vs. Gate Voltage

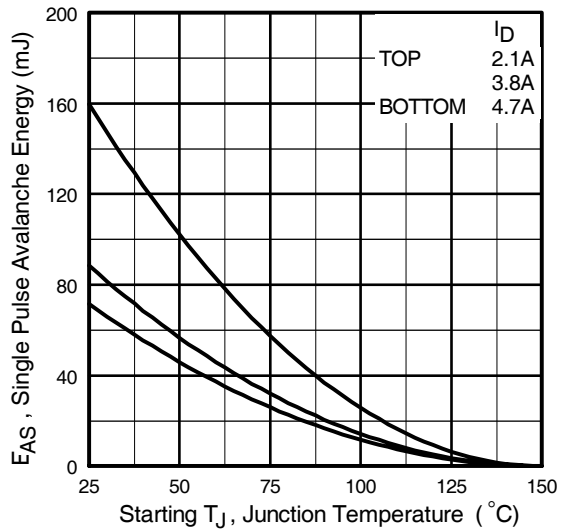

Fig 8. Maximum Avalanche Energy Vs. Drain Current

N-Channel

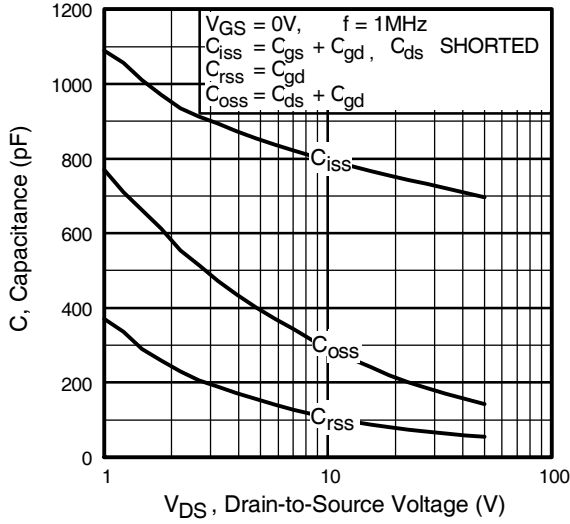

Fig 9. Typical Capacitance Vs. Drain-to-Source Voltage

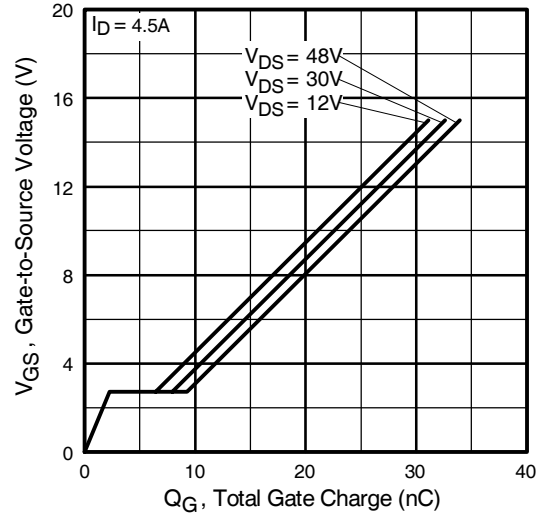

Fig 10. Typical Gate Charge Vs. Gate-to-Source Voltage

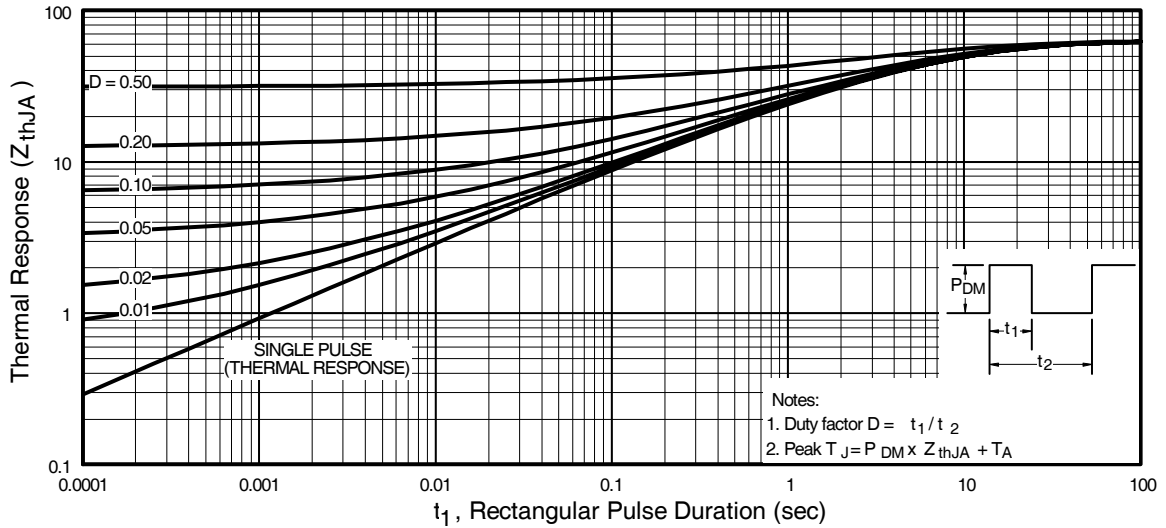

Fig 11. Maximum Effective Transient Thermal Impedance, Junction-to-Ambient

P-Channel

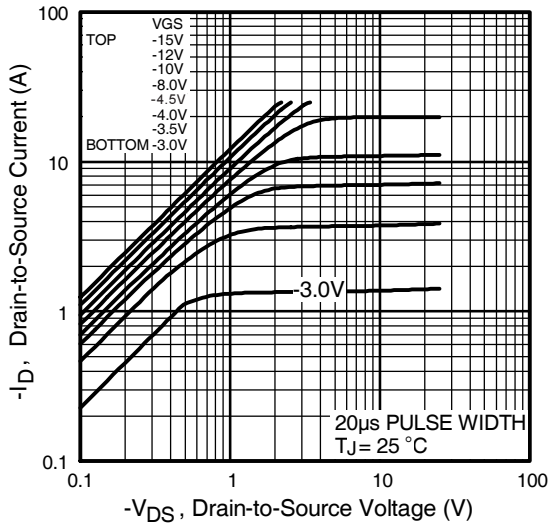

Fig 12. Typical Output Characteristics

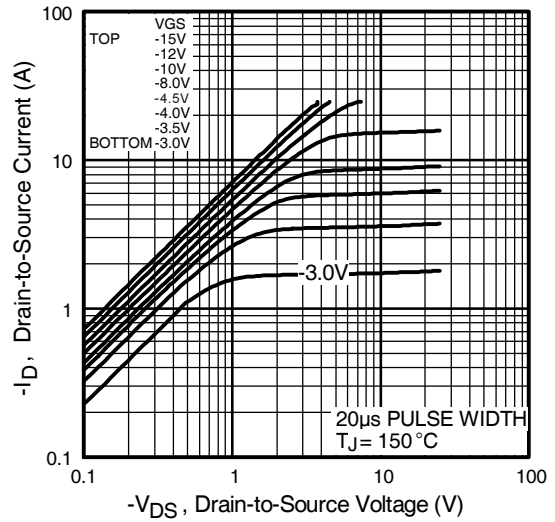

Fig 13. Typical Output Characteristics

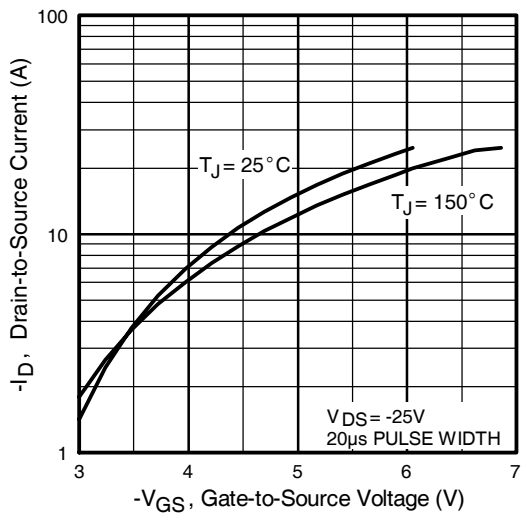

Fig 14. Typical Transfer Characteristics

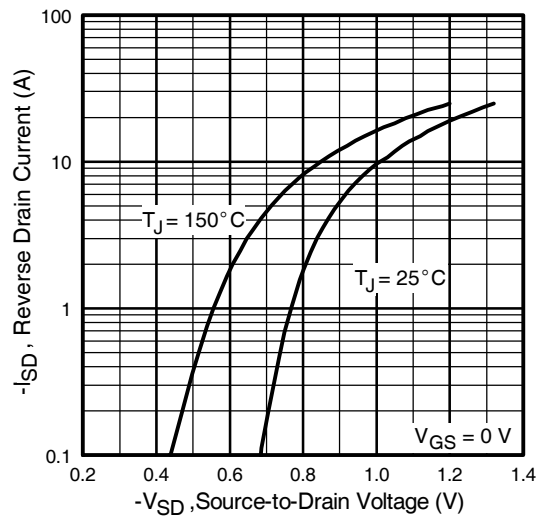

Fig 15. Typical Source-Drain Diode Forward Voltage

P-Channel

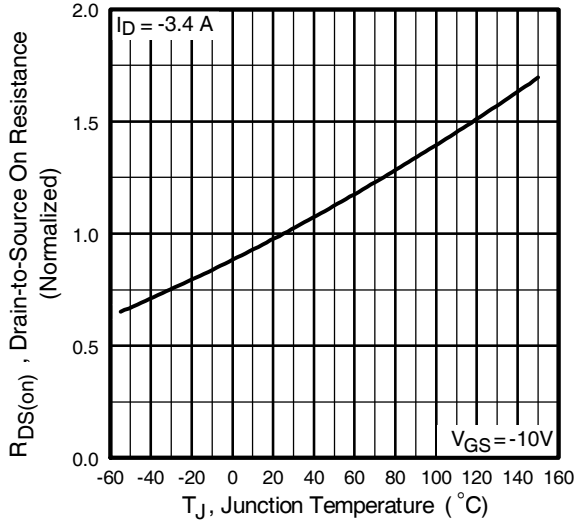

Fig 16. Normalized On-Resistance Vs. Temperature

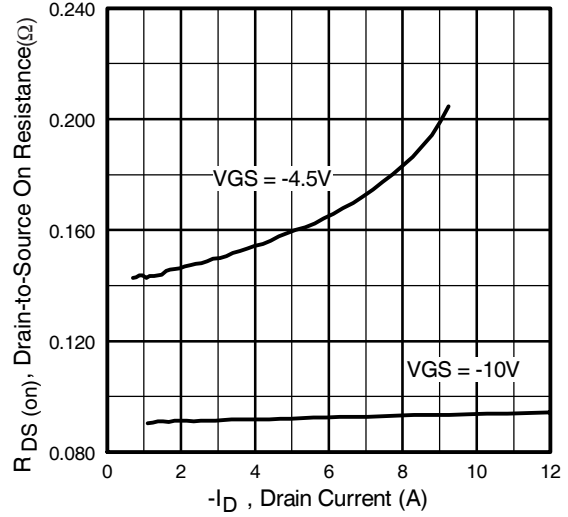

Fig 17. Typical On-Resistance Vs. Drain Current

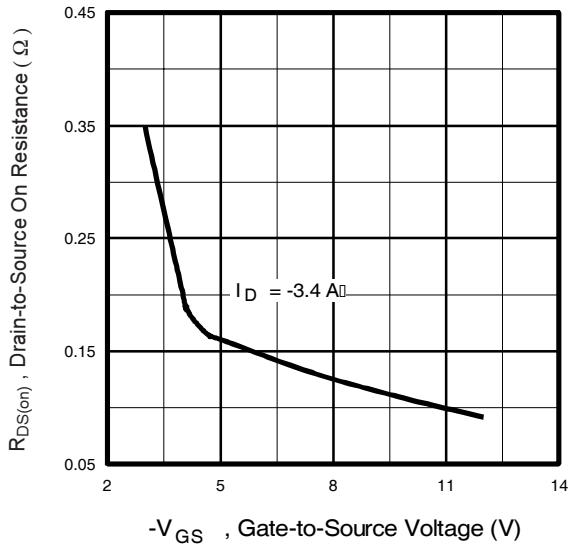

Fig 18. Typical On-Resistance Vs. Gate Voltage

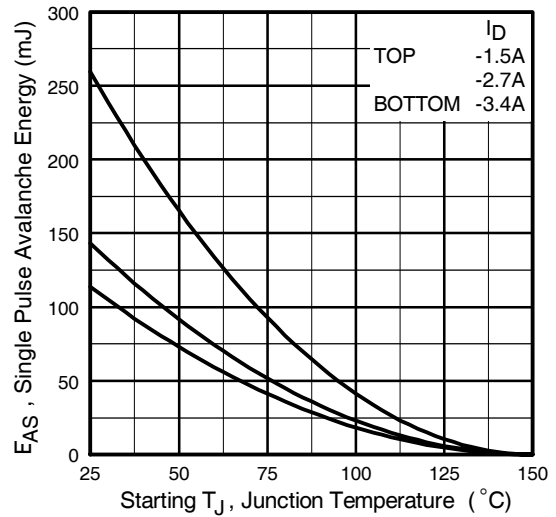

Fig 19. Maximum Avalanche Energy Vs. Drain Current

P-Channel

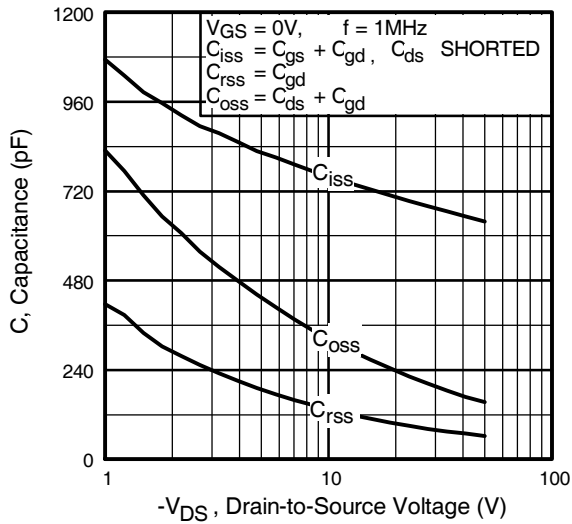

Fig 20. Typical Capacitance Vs. Drain-to-Source Voltage

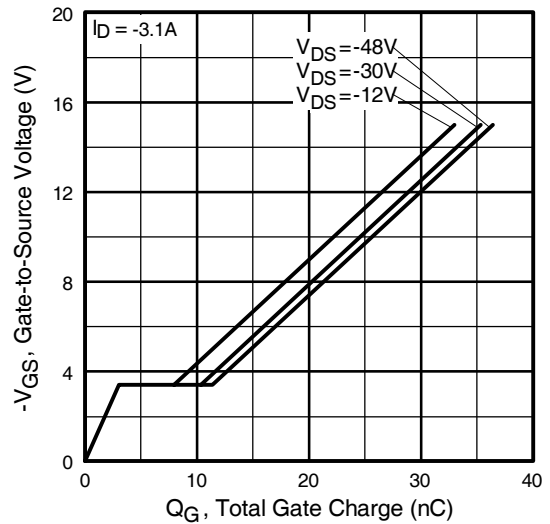

Fig 21. Typical Gate Charge Vs. Gate-to-Source Voltage

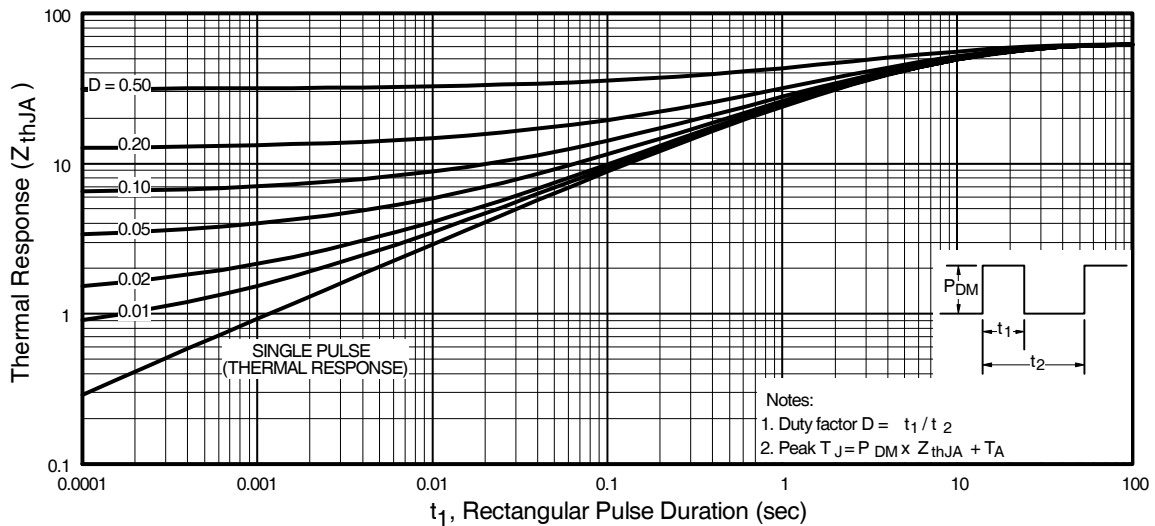
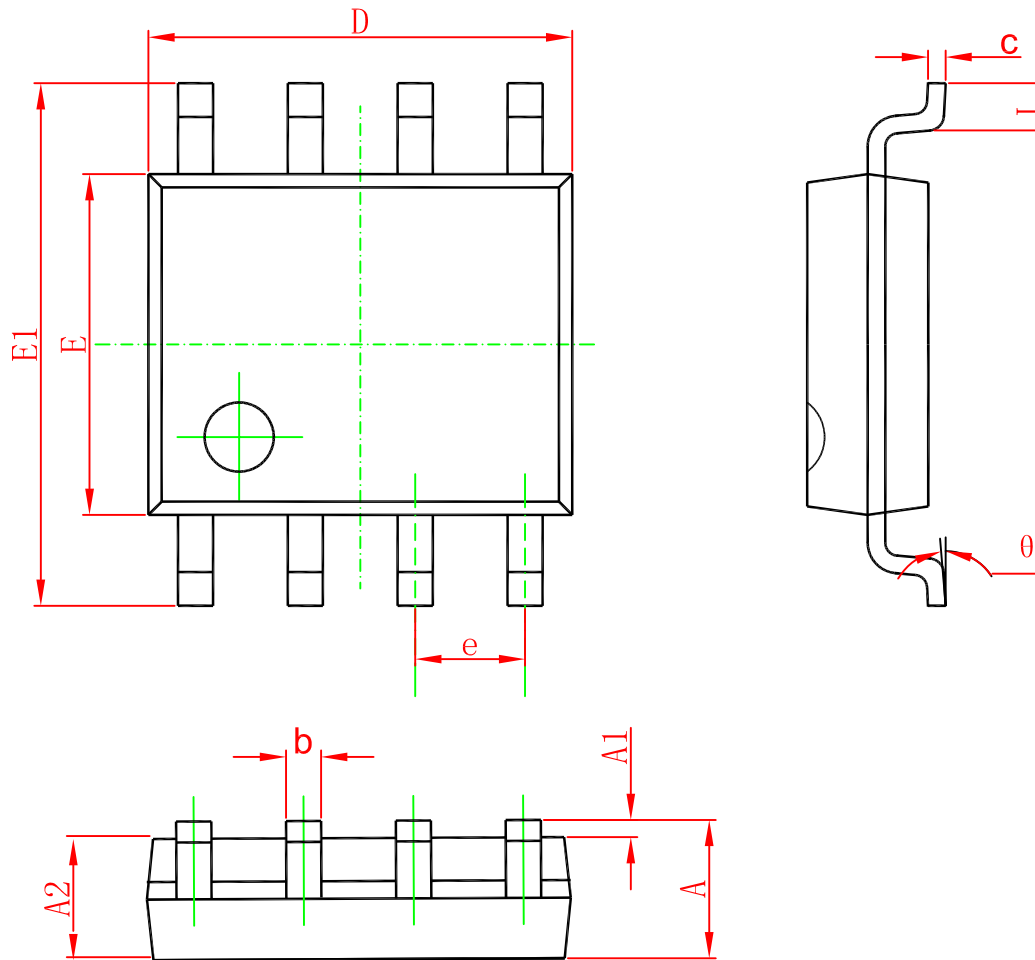

Fig 22. Maximum Effective Transient Thermal Impedance, Junction-to-Ambient

SOP-8



Symbol	Dimensions In Millimeters		Dimensions In Inches	
	Min	Max	Min	Max
A	1.350	1.750	0.053	0.069
A1	0.100	0.250	0.004	0.010
A2	1.350	1.550	0.053	0.061
b	0.330	0.510	0.013	0.020
c	0.170	0.250	0.006	0.010
D	4.700	5.100	0.185	0.200
E	3.800	4.000	0.150	0.157
E1	5.800	6.200	0.228	0.244
e	1.270(BSC)		0.050(BSC)	
L	0.400	1.270	0.016	0.050
θ	0°	8°	0°	8°

Marking

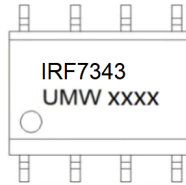

Ordering information

Order code	Package	Baseqty	Deliverymode
UMW IRF7343TR	SOP-8	3000	Tape and reel