

## Data sheet

Commercial Art.No.: 25.841.3353.0

PCB connector 8213 BFK / 3 TOP F OB

PCB female connector with tension spring connection, 3 poles, max. cross section: 2.5 mm<sup>2</sup>, pitch: 5.08 mm, type of packing: carton, color: grey



Commercial Art.No.	25.841.3353.0
EAN	4015573615151
Order Unit	100

Certificates / Approvals



## Technical data

### General

Modular spacing	5.08 mm
Connection type	spring clamp connection
Soldering process	None
Packaging	Carton
Number of poles	3
Marking	No
Fastening	Flange
Mating direction towards connector	180°

### Technical data

Nominal cross section	2.5 mm <sup>2</sup>
Rated current	12 A
Overvoltage Category I	1000 V
Overvoltage Category II	400 V
Overvoltage Category III	250 V
Rated impulse voltage	4 kV
Wire strip length	11 mm

### Connection Data

Minimum cross section solid	0.14 mm <sup>2</sup>
Maximum cross section solid	2.5 mm <sup>2</sup>
Minimum cross section fine stranded	0.14 mm <sup>2</sup>
Maximum cross section fine stranded	2.5 mm <sup>2</sup>
Wire strip length	11 mm

### Technical Data UL/CSA

Cross section UL	22-12 AWG
------------------	-----------

Voltage UL	300 V
Current field wiring	12 A
Current factory wiring	12 A
Cross section CSA	22-16 AWG
Voltage CSA	300 V
Current CSA	12 A

#### Other

Type of insulation material	Thermoplastic
Color	Grey
Height	15 mm
Length	15.24 mm
Depth	24.3 mm
Material attachment screw	None
Material contact base	Steel
Material contact surface	Sn

#### Classification

ECLASS 11	
ECLASS 8.1	27440402
ETIM 7.0	EC002637
ETIM 6.0	EC002637
ETIM 5.0	EC002637
ETIM 4.0	EC002637

#### Product compliance

ROHS conformity status	Compliant
REACH-SVHC conformity status	Compliant

#### Fits with

Commercial Art.No.:	Article-type description:	Description:
25.358.3353.0	PCB pin header 8213 S / 3 WF OB	PCB pin header, connection method depends on used socket part , 3 poles, pitch: 5.08 mm, type of packing: carton, color: grey
25.359.3353.0	PCB pin header 8213 S / 3 GF OB	PCB pin header, connection method depends on used socket part , 3 poles, pitch: 5.08 mm, type of packing: carton, color: grey
25.359.3306.0	PCB pin header 8213 S / 3 GF THR	PCB pin header, connection method depends on used socket part , 3 poles, with solder pin (2.6mm, tin plated), pitch: 5.08 mm, type of packing: carton, color: grey, This product can be soldered by reflow and wave soldering,

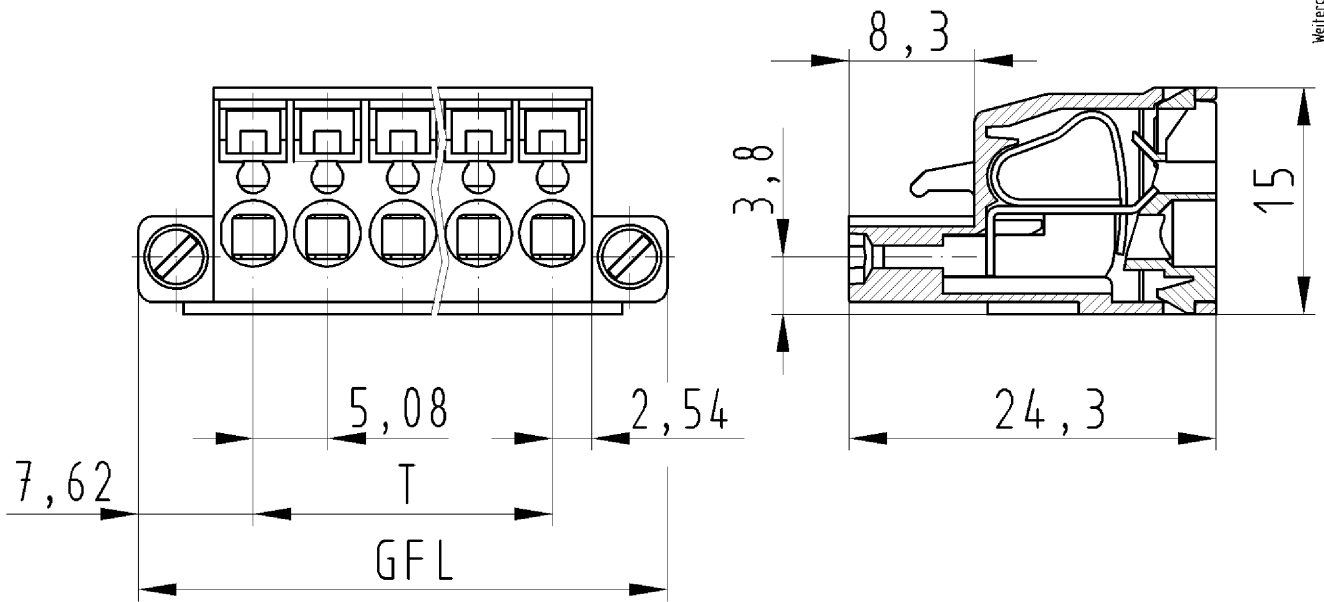

für folgende Tabellen-Zchnng.:  
25.841.3253.0 8213 BFK/.. TOP K F OB

LP . STECKKLEMME  
25.841.3253.0 10W  
06.11.2007 DÜT  
M 2:1