

**KB845**

GENERAL PURPOSE  
HIGH ISOLATION VOLTAGE  
HIGH SENSITIVITY  
PHOTOCOUPLER SERIES

**FEATURES**

- 1.High current transfer ratio. (CTR:MIN.600% at  $I_F=1\text{mA}$ ,  $V_{CE}=2\text{V}$ )
- 2.High isolation voltage between input and output ( $V_{iso}=5000\text{Vrms}$ )
- 3.Compact dual-in-line package  
KB845:4-channel type
4. Recognized by UL and CUL, file NO. E225308

**DESCRIPTION**

- 1.The KB845 (4-channel) is optically coupled isolators containing a GaAs light emitting diode and a darlington silicon phototransistor.
- 2.The lead pitch is 2.54mm

**APPLICATIONS**

- 1.Computer terminals
- 2.Registers, copiers, automatic vending machines
- 3.System appliances, measuring instruments
- 4.Industrial robots
- 5.Signal transmission between circuits of different potentials and impedances

### KB845

\* PACKAGE DIMENSIONS (UNIT: mm)

DIP Type

TOLERANCE :  $\pm 0.5[\pm 0.02]$  UNLESS OTHERWISE NOTED.

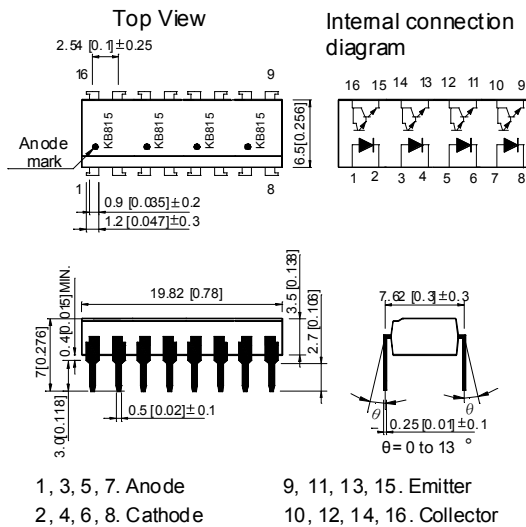

\* Absolute Maximum Ratings (Ta=25°C)

Parameter		Symbol	Rating	Unit
Input	Forward current	I <sub>F</sub>	50	mA
	Power dissipation	P	70	mW
Output	Collector-emitter voltage	V <sub>CEO</sub>	35	V
	Emitter-collector voltage	V <sub>ECO</sub>	6	V
	Collector current	I <sub>C</sub>	80	mA
	Collector power dissipation	P <sub>C</sub>	150	mW
Total	power dissipation	P <sub>tot</sub>	200	mW
*1 Isolation voltage		Viso	5000	V <sub>rms</sub>
Operating temperature		T <sub>opr</sub>	-30~+100	°C
Storage temperature		T <sub>stg</sub>	-55~+125	°C
*2 Soldering temperature		T <sub>sol</sub>	260	°C

\*1 40 to 60%RH, AC for 1 minute

\*2 For 10 seconds

\* Electro-optical Characteristics

Parameter		Symbol	Conditions	Min.	Typ.	Max.	Unit	
Input	Forward voltage	$V_F$	$I_F=20\text{mA}$	—	1.2	1.4	V	
	Peak forward voltage	$V_{FM}$	$I_{FM}=0.5\text{A}$	—	—	3.0	V	
	Reverse current	$I_R$	$V_R=4\text{V}$	—	—	10	$\mu\text{A}$	
Output	Collector dark current	$I_{CED}$	$V_{CE}=10\text{V}, I_F=0\text{mA}$	—	—	$10^{-6}$	A	
Transfer characteristics	*1 Current transfer ratio	CTR	$I_F=1\text{mA}, V_{CE}=2\text{V}$	600	1600	7500	%	
	Collector-emitter saturation voltage	$V_{CE(sat)}$	$I_F=20\text{mA}, I_C=5\text{mA}$	—	0.8	1.0	V	
	Response time	Rise time	$t_r$	$V_{CE}=2\text{V}, I_C=10\text{mA}, R_L=100\Omega$	—	60	300	$\mu\text{S}$
		Fall time	$t_f$		—	53	250	$\mu\text{S}$

\*1  $CTR = \frac{I_C}{I_F} \times 100\%$

Fig. 1 Current Transfer Ratio vs. Forward Current

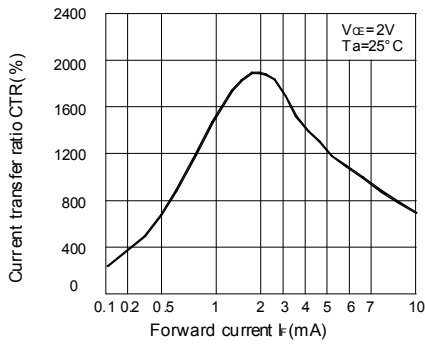

Fig. 2 Forward Current vs. Forward voltage

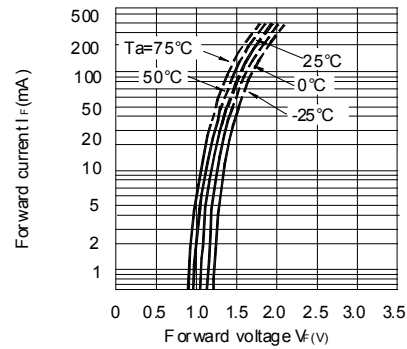

Fig. 3 Collector Current vs. Collector-emitter Voltage

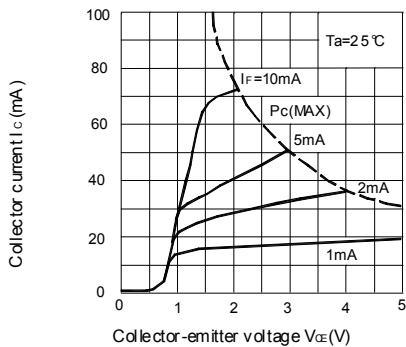

Fig. 4 Relative Current Transfer Ratio vs. Ambient Temperature

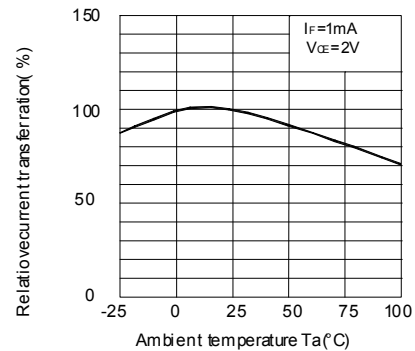

Fig. 5 Collector-emitter Saturation Voltage vs. Ambient Temperature

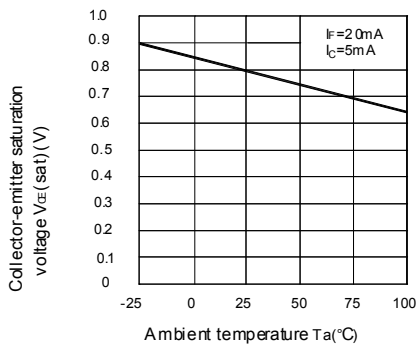
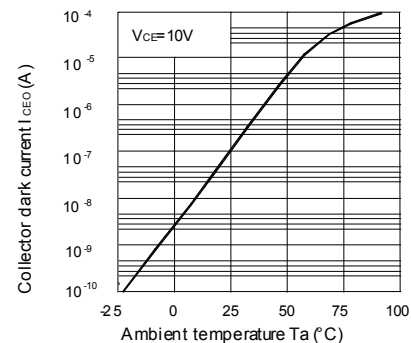

Fig. 6 Collector Dark Current vs. Ambient Temperature



## KB845

Fig. 7 Forward Current vs. Ambient Temperature

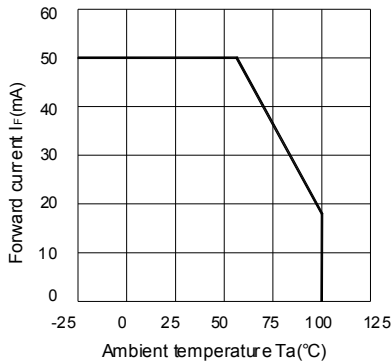

Fig. 8 Collector Power Dissipation vs. Ambient Temperature

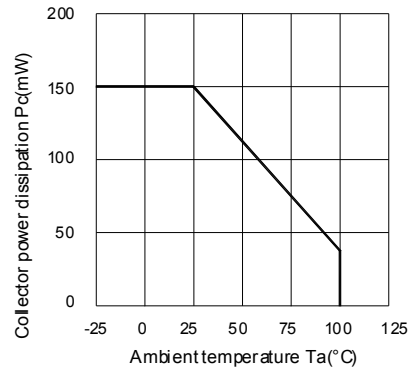
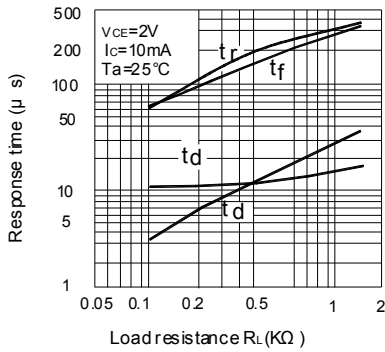

Fig. 9 Response Time vs. Load Resistance



Test Circuit for Response Time

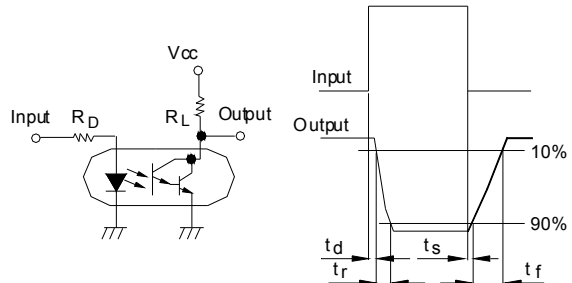
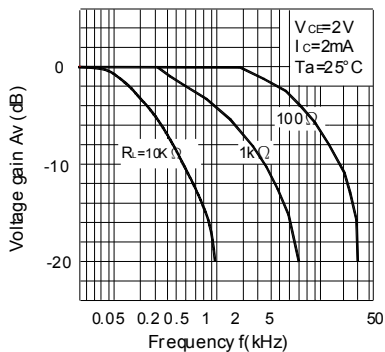
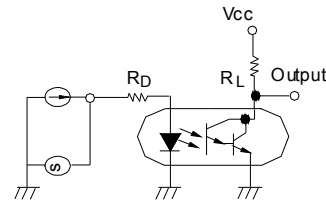

Fig. 10 Frequency Response



Test Circuit for Frequency Response



**Fig. 11 Collector-emitter Saturation Voltage vs. Forward Current**

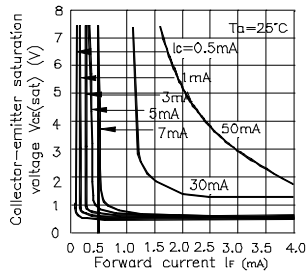

**\* NOTES ON HANDLING**

**1.Recommended soldering conditions (Dip soldering)**

**(1) Dip soldering**

Temperature	260°C or below (molten solder temperature)
Time	Less than 10 seconds.
Cycle	One cycle allowed to be dipped in solder including plastic mold portion.
Flux	Rosin flux containing small amount of chlorine (The flux with a maximum chlorine content of 0.2 Wt % is recommended.)

**(2) Cautions**

**Fluxes**

Avoid removing the residual flux with freon-based and chlorine-based cleaning solvent.

**2.Cautions regarding noise**

Be aware that power is suddenly into the component any surge current may cause damage happen, even if the voltage is within the absolute maximum ratings.

### CAUTION

Within this device there exists GaAs (Gallium Arsenide) material which is a harmful substance if ingested. GaAs dust and fumes are toxic. Do not break, cut or pulverize the product, or use chemicals to dissolve them.

### RESTRICTIONS ON PRODUCT USE

- The information in this document is subject to change without notice. Before using this document, please confirm that this is the latest version. Not all devices / types available in every country.
- We are mention about our product quality stability, semiconductor devices in general can malfunction or fail due to their inherent electrical sensitivity and vulnerability to physical stress. It is the responsibility of the buyer, when utilizing KINGBRIGHT products, to observe standards of safety, and to a avoid situations in which a malfunction or failure of a KINGBRIGHT product could cause loss of human life, bodily injury or damage to property. In developing your designs, please ensure that KINGBRIGHT products are used with in specified operating ranges as set forth in the most recent products specifications.

### KB845

Dimension of Tube

TOLERANCE :  $\pm 0.4[\pm 0.012]$  UNLESS OTHERWISE NOTED.

Unit:mm

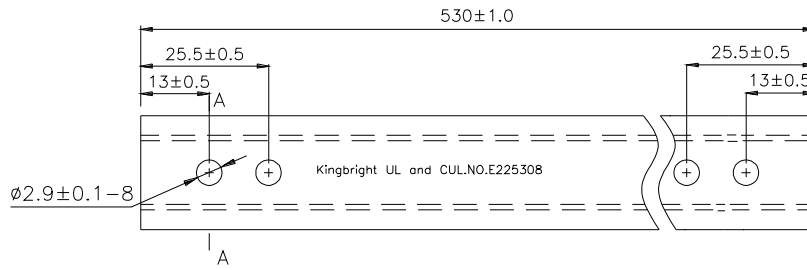

A-A Side view

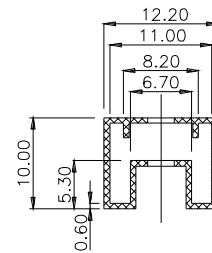
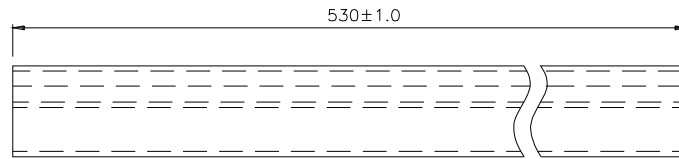

Dimension of Carton

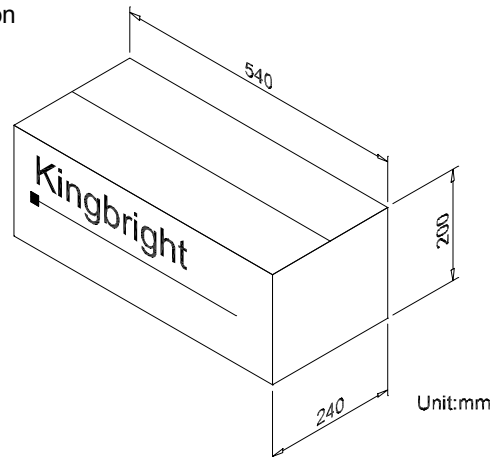

#### \* ORDERING INFORMATION

Part Number	Package	Packing Style
KB845	16-pin DIP	25pcs / each tube