



FEATURES:

- RoHS compliant
- 24 Pin DIP Package
- Ultra-wide 4:1 input range
- High efficiency up to 83%
- Operating temperature -40°C to + 85°C
- Input / Output Isolation 1500VDC
- Pin compatible with multiple manufacturers
- Continuous short circuit protection



Models Single output

Model	Input Voltage (V)	Output Voltage (V)	Output Current max (mA)	Isolation (VDC)	Max. Cap. Load (µF)	Efficiency (%)
AM3TW-2403S-NZ	9-36	3.3	909	1500	2700	75
AM3TW-2405S-NZ	9-36	5	600	1500	2200	80
AM3TW-2409S-NZ	9-36	9	333	1500	1000	80
AM3TW-2412S-NZ	9-36	12	250	1500	680	81
AM3TW-2415S-NZ	9-36	15	200	1500	680	82
AM3TW-2424S-NZ	9-36	24	125	1500	470	82
AM3TW-4803S-NZ	18-75	3.3	909	1500	2700	76
AM3TW-4805S-NZ	18-75	5	600	1500	2200	79
AM3TW-4809S-NZ	18-75	9	333	1500	1000	81
AM3TW-4812S-NZ	18-75	12	250	1500	680	82
AM3TW-4815S-NZ	18-75	15	200	1500	680	83
AM3TW-4824S-NZ	18-75	24	125	1500	470	81

NOTE: All specifications are measured at an ambient temperature of 25°C, humidity<75%, nominal input voltage and at rated output load unless otherwise specified.

Input Specifications

Parameters	Nominal	Typical	Maximum	Units
Voltage range	24 Vin	9-36		VDC
	48 Vin	18-75		
Filter	π (Pi) Network			
Absolute maximum (1sec max)	24 Vin		-0.7 - 50	VDC
	48 Vin		-0.7 - 100	
Full load Input current	24 Vin	156		mA
	48 Vin	79		
Quiescent Input current	24 Vin	10		mA
	48 Vin	8		
Input Reflected Ripple current		30		mA

Isolation Specifications

Parameters	Conditions	Typical	Maximum	Units
Tested I/O voltage	60 sec, <1mA	1500		VDC
Resistance	Isolation Voltage 500VDC	> 1000		MOhm
Capacitance	I/O 100KHz, 0.1V	120		pF

Output Specifications

Parameters	Conditions	Typical	Maximum	Units
Voltage accuracy		±1	±3	%
Short Circuit protection		Continuous		
Short circuit restart		Auto-recovery		
Line voltage regulation	LL-HL, full load	±0.2	±0.5	%
Load voltage regulation	5% - 100% load	±0.2	±1	%
Temperature coefficient		±0.02	±0.03	%/°C

Output Specifications (continued)

Parameters	Conditions	Typical	Maximum	Units
Ripple	20MHz bandwidth	45		mV p-p
Noise	20MHz bandwidth	85		mV p-p
Transient Recovery Time	25% Load Step	0.5	3	m sec
Transient Deviation	25% Load Step	±2	±5	%
Over load protection		>120		%

General Specifications

Parameters	Conditions	Typical	Maximum	Units
Switching frequency	100% load, PFM	250		KHz
Operating temperature	With derating above +71C		-40 to +85	°C
Storage temperature			-55 to +125	°C
Max Case temperature			100	°C
Temperature Rise	Full Load, 25°C	25°C		°C
Lead Temperature	1.5mm from case for 10 Seconds		300	°C
Cooling		Free air convection		
Humidity			95	% RH
Case material		Black Aluminum Alloy		
Weight		14		g
Dimensions (L x W x H)		1.26 x 0.80 x 0.42 inches	32.00 x 20.00 x 10.80mm	
MTBF		>1 000 000 hrs (MIL-HDBK -217F, Ground Benign, t=+25°C)		

Safety Specifications

Parameters	
Standards	Designed to meet EN 55022, Class B, with external filter & EN 55024: 2010 IEC 61000-4-2, Contact ±4KV/Air ±8KV, Criteria B IEC 61000-4-3, 10V/m, Criteria A IEC 61000-4-4, ±2KV, Criteria B, with external filter IEC 61000-4-5, ±2KV, Criteria B, with external filter IEC 61000-4-6, 3Vrms, Criteria A IEC 61000-4-29, 0-70%, Criteria B

Pin Out Specifications

Pin	Single
2	-V Input
3	-V Input
9	No pin
11	N.C.
14	+V Output
16	-V Output
22	+V Input
23	+V Input

N.C.: not connected

Dimensions

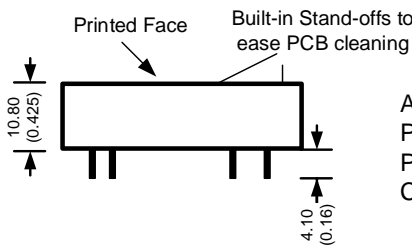
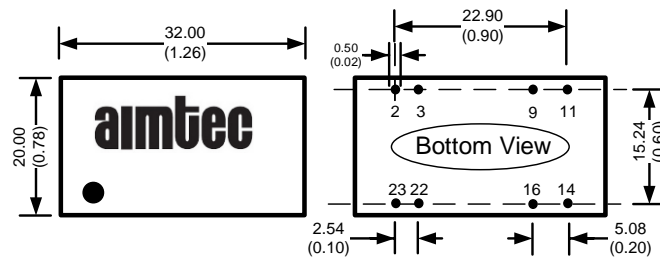

All dimensions are typical: millimeters (inches)
 Pin Diameter: 0.50 ± 0.05 (0.02 ± 0.002)
 Pin Pitch Tolerance: ± 0.35 (±0.014)
 Case Tolerance: ± 0.5 (±0.02)

Filtering Single output

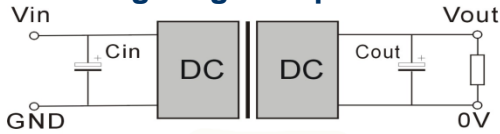

External capacitors

Vin (VDC)	Cin (uF)	Cout (uF)
24 & 48	10-47	10

Recommended Circuit

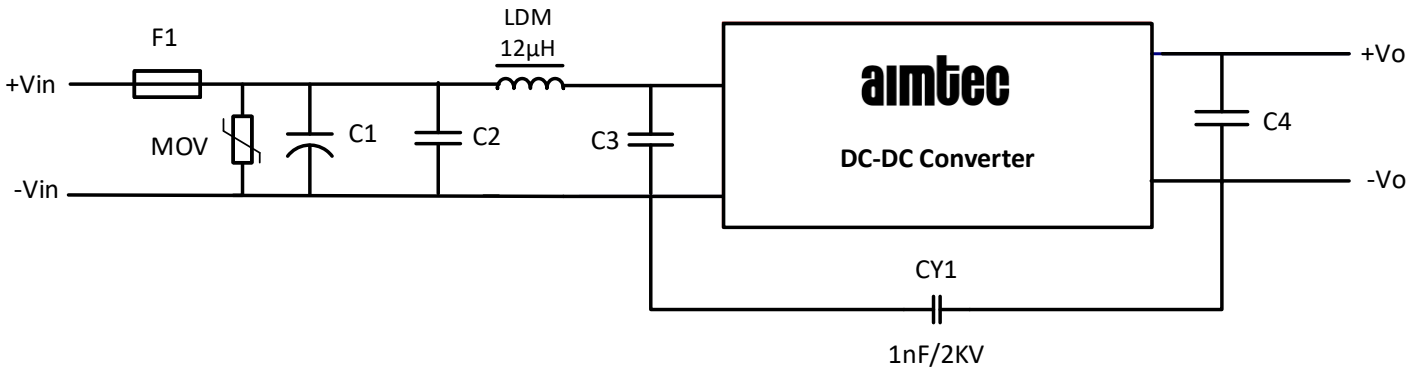

Model	MOV	C1	C2 & C3	C4
24 Vin	S14K35	330 μ F / 50V	4.7 μ F / 50V	10 μ F
48 Vin	S14K60	330 μ F / 100V	4.7 μ F / 100V	10 μ F

Note: Fuse is user selectable

Derating

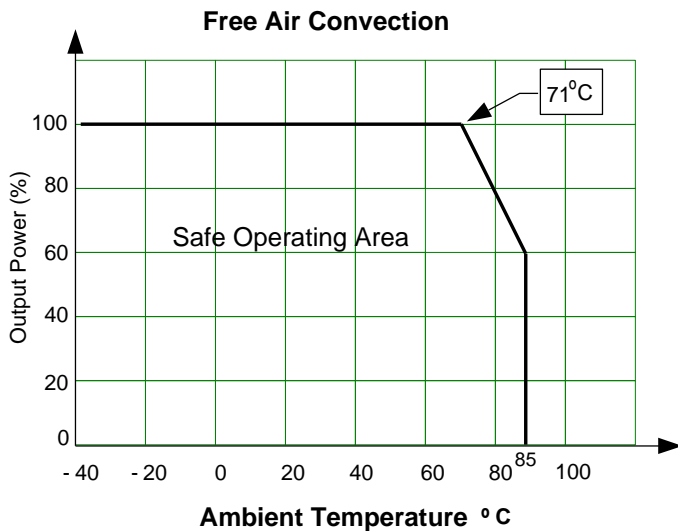

NOTE: 1. Datasheets are updated as needed and as such, specifications are subject to change without notice. Once printed or downloaded, datasheets are no longer controlled by Aimtec; refer to www.aimtec.com for the most current product specifications. 2. Product labels shown, including safety agency certifications on labels, may vary based on the date manufactured. 3. Mechanical drawings and specifications are for reference only. 4. All specifications are measured at an ambient temperature of 25°C, humidity<75%, nominal input voltage and at rated output load unless otherwise specified. 5. Aimtec may not have conducted destructive testing or chemical analysis on all internal components and chemicals at the time of publishing this document. CAS numbers and other limited information are considered proprietary and may not be available for release. 6. This product is not designed for use in critical life support systems, equipment used in hazardous environments, nuclear control systems or other such applications which necessitate specific safety and regulatory standards other the ones listed in this datasheet. 7. Warranty is in accordance with Aimtec's standard Terms of Sale available at www.aimtec.com.