

IRG4PSC71UPbF

INSULATED GATE BIPOLAR TRANSISTOR

UltraFast Speed IGBT

Features

- UltraFast switching speed optimized for operating frequencies 8 to 40kHz in hard switching, 200kHz in resonant mode soft switching
- Generation 4 IGBT design provides tighter parameter distribution and higher efficiency (minimum switching and conduction losses) than prior generations
- Industry-benchmark Super-247 package with higher power handling capability compared to same footprint TO-247
- Creepage distance increased to 5.35mm
- Lead-Free

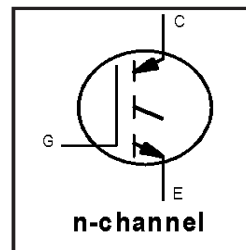

| |
|-----------------------------------|
| $V_{CES} = 600V$ |
| $V_{CE(on)} \text{ typ.} = 1.67V$ |
| @ $V_{GE} = 15V, I_C = 60A$ |

Benefits

- Generation 4 IGBT's offer highest efficiencies available
- Maximum power density, twice the power handling of the TO-247, less space than TO-264
- IGBTs optimized for specific application conditions
- Cost and space saving in designs that require multiple, paralleled IGBTs

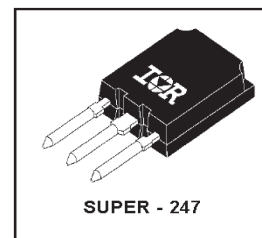

Absolute Maximum Ratings

| | Parameter | Max. | Units |
|---------------------------|---|-----------------------------------|-------|
| V_{CES} | Collector-to-Emitter Breakdown Voltage | 600 | V |
| $I_C @ T_C = 25^\circ C$ | Continuous Collector Current | 85 ^⑥ | A |
| $I_C @ T_C = 100^\circ C$ | Continuous Collector Current | 60 | |
| I_{CM} | Pulsed Collector Current ^① | 200 | |
| I_{LM} | Clamped Inductive Load Current ^② | 200 | |
| V_{GE} | Gate-to-Emitter Voltage | ± 20 | V |
| E_{ARV} | Reverse Voltage Avalanche Energy ^③ | 180 | mJ |
| $P_D @ T_C = 25^\circ C$ | Maximum Power Dissipation | 350 | W |
| $P_D @ T_C = 100^\circ C$ | Maximum Power Dissipation | 140 | |
| T_J | Operating Junction and | -55 to + 150 | °C |
| T_{STG} | Storage Temperature Range | | |
| | Soldering Temperature, for 10 seconds | 300 (0.063 in. (1.6mm from case) | |

Thermal Resistance\ Mechanical

| | Parameter | Min. | Typ. | Max. | Units |
|-----------------|---|-----------|----------|------|---------|
| $R_{\theta JC}$ | Junction-to-Case | --- | --- | 0.36 | °C/W |
| $R_{\theta CS}$ | Case-to-Sink, flat, greased surface | --- | 0.24 | --- | |
| $R_{\theta JA}$ | Junction-to-Ambient, typical socket mount | --- | --- | 38 | |
| | Recommended Clip Force | 20.0(2.0) | --- | --- | N (kgf) |
| | Weight | --- | 6 (0.21) | --- | g (oz) |

IRG4PSC71UPbF

International
IR Rectifier

Electrical Characteristics @ $T_J = 25^\circ\text{C}$ (unless otherwise specified)

| | Parameter | Min. | Typ. | Max. | Units | Conditions |
|---------------------------------|--|------|------|-----------|---------|---|
| $V_{(BR)CES}$ | Collector-to-Emitter Breakdown Voltage | 600 | — | — | V | $V_{GE} = 0V, I_C = 250\mu A$ |
| $V_{(BR)ECS}$ | Emitter-to-Collector Breakdown Voltage ④ | 18 | — | — | V | $V_{GE} = 0V, I_C = 1.0A$ |
| $\Delta V_{(BR)CES}/\Delta T_J$ | Temperature Coeff. of Breakdown Voltage | — | 0.45 | — | V/°C | $V_{GE} = 0V, I_C = 5.0mA$ |
| $V_{CE(ON)}$ | Collector-to-Emitter Saturation Voltage | — | 1.67 | 2.0 | V | $I_C = 60A, V_{GE} = 15V$ |
| | | — | 1.95 | — | | $I_C = 100A$ |
| | | — | 1.71 | — | | $I_C = 60A, T_J = 150^\circ\text{C}$ |
| $V_{GE(th)}$ | Gate Threshold Voltage | 3.0 | — | 6.0 | | $V_{CE} = V_{GE}, I_C = 250\mu A$ |
| $\Delta V_{GE(th)}/\Delta T_J$ | Temperature Coeff. of Threshold Voltage | — | -10 | — | mV/°C | $V_{CE} = V_{GE}, I_C = 1.0mA$ |
| g_{fe} | Forward Transconductance ⑤ | 47 | 70 | — | S | $V_{CE} = 50V, I_C = 60A$ |
| I_{CES} | Zero Gate Voltage Collector Current | — | — | 500 | μA | $V_{GE} = 0V, V_{CE} = 600V$ |
| | | — | — | 2.0 | | $V_{GE} = 0V, V_{CE} = 10V, T_J = 25^\circ\text{C}$ |
| | | — | — | 5.0 | mA | $V_{GE} = 0V, V_{CE} = 600V, T_J = 150^\circ\text{C}$ |
| I_{GES} | Gate-to-Emitter Leakage Current | — | — | ± 100 | nA | $V_{GE} = \pm 20V$ |

Switching Characteristics @ $T_J = 25^\circ\text{C}$ (unless otherwise specified)

| | Parameter | Min. | Typ. | Max. | Units | Conditions |
|--------------|-----------------------------------|------|------|------|-------|--|
| Q_g | Total Gate Charge (turn-on) | — | 340 | 520 | nC | $I_C = 60A$ |
| Q_{ge} | Gate - Emitter Charge (turn-on) | — | 44 | 66 | | $V_{CC} = 400V$ |
| Q_{gc} | Gate - Collector Charge (turn-on) | — | 160 | 240 | | $V_{GE} = 15V$ |
| $t_{d(on)}$ | Turn-On Delay Time | — | 34 | — | ns | $T_J = 25^\circ\text{C}$ $I_C = 60A, V_{CC} = 480V$ $V_{GE} = 15V, R_G = 5.0\Omega$ |
| t_r | Rise Time | — | 50 | — | | |
| $t_{d(off)}$ | Turn-Off Delay Time | — | 56 | 84 | | |
| t_f | Fall Time | — | 86 | 130 | | |
| E_{on} | Turn-On Switching Loss | — | 0.42 | — | mJ | Energy losses include "tail" See Fig. 10, 11, 13, 14 |
| E_{off} | Turn-Off Switching Loss | — | 1.99 | — | | |
| E_{ts} | Total Switching Loss | — | 2.41 | 3.2 | | |
| $t_{d(on)}$ | Turn-On Delay Time | — | 30 | — | ns | $T_J = 150^\circ\text{C}$, $I_C = 60A, V_{CC} = 480V$ $V_{GE} = 15V, R_G = 5.0\Omega$ |
| t_r | Rise Time | — | 49 | — | | |
| $t_{d(off)}$ | Turn-Off Delay Time | — | 129 | — | | |
| t_f | Fall Time | — | 175 | — | | |
| E_{ts} | Total Switching Loss | — | 4.5 | — | mJ | See Fig. 13, 14 |
| L_E | Internal Emitter Inductance | — | 13 | — | nH | Measured 5mm from package |
| C_{ies} | Input Capacitance | — | 7500 | — | pF | $V_{GE} = 0V$ $V_{CC} = 30V$ |
| C_{oes} | Output Capacitance | — | 720 | — | | |
| C_{res} | Reverse Transfer Capacitance | — | 93 | — | | |

Notes:

- ① Repetitive rating; $V_{GE} = 20V$, pulse width limited by max. junction temperature. (See fig. 13b)
- ② $V_{CC} = 80\%(V_{CES}), V_{GE} = 20V, L = 10\mu H, R_G = 5.0\Omega$, (See fig. 13a)
- ③ Repetitive rating; pulse width limited by maximum junction temperature.
- ④ Pulse width $\leq 80\mu s$; duty factor $\leq 0.1\%$.
- ⑤ Pulse width $5.0\mu s$, single shot.
- ⑥ Current limited by the package, (Die current = 100A)

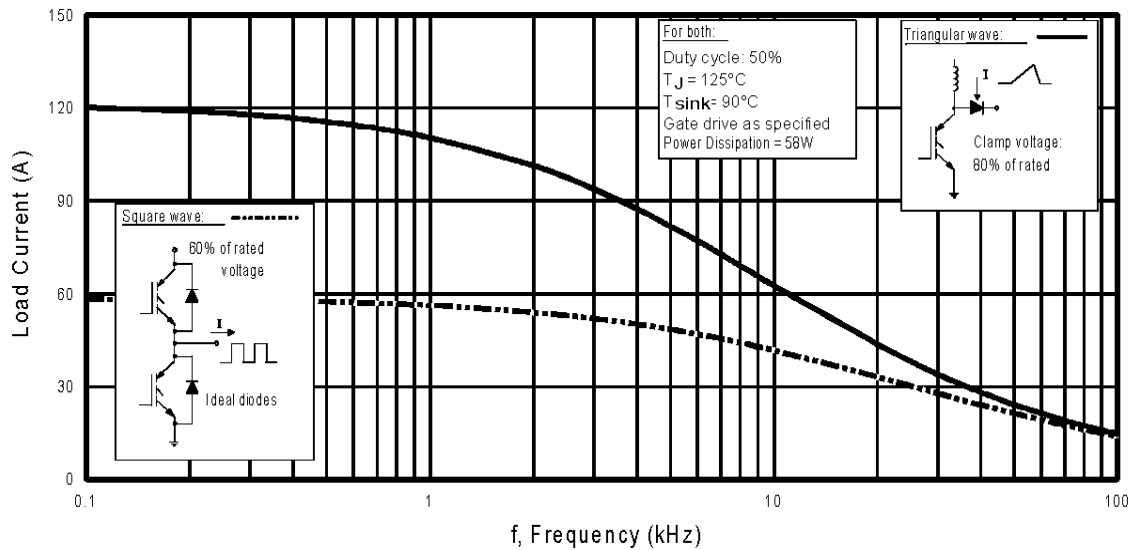

Fig. 1 - Typical Load Current vs. Frequency
 (For square wave, $I = I_{\text{RMS}}$ of fundamental; for triangular wave, $I = I_{\text{PK}}$)

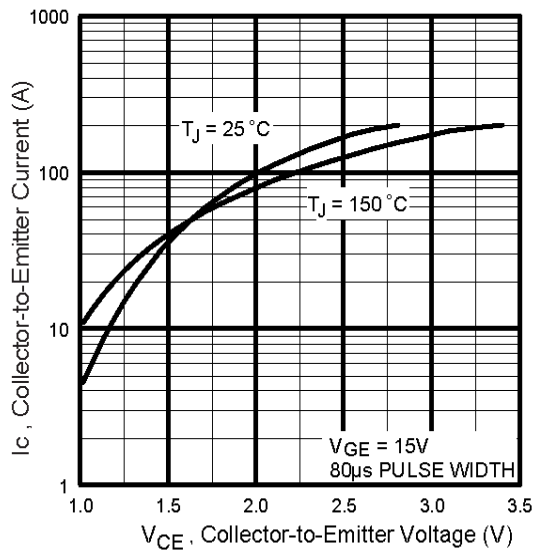

Fig. 2 - Typical Output Characteristics

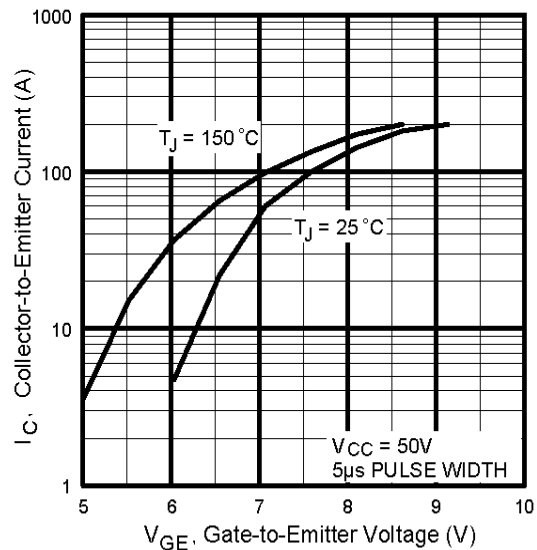

Fig. 3 - Typical Transfer Characteristics

IRG4PSC71UPbF

International
IR Rectifier

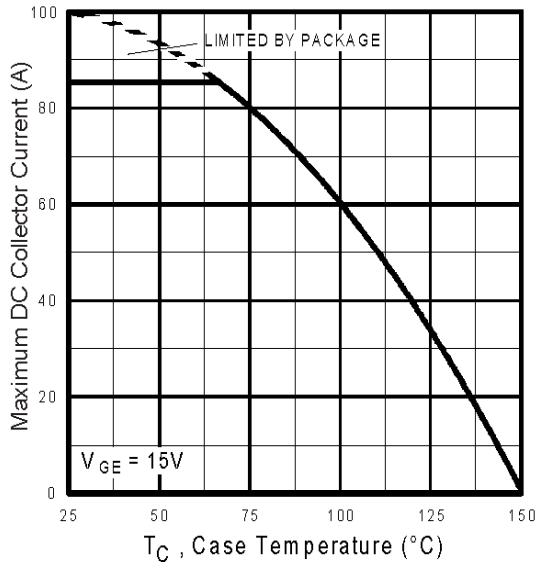

Fig. 4 - Maximum Collector Current vs. Case Temperature

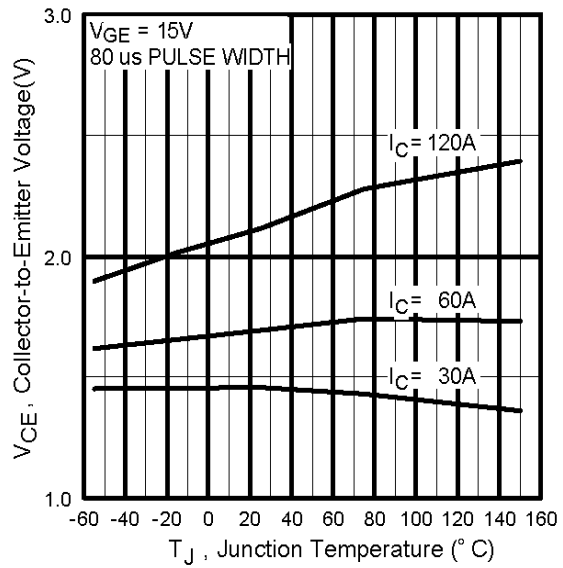

Fig. 5 - Collector-to-Emitter Voltage vs. Junction Temperature

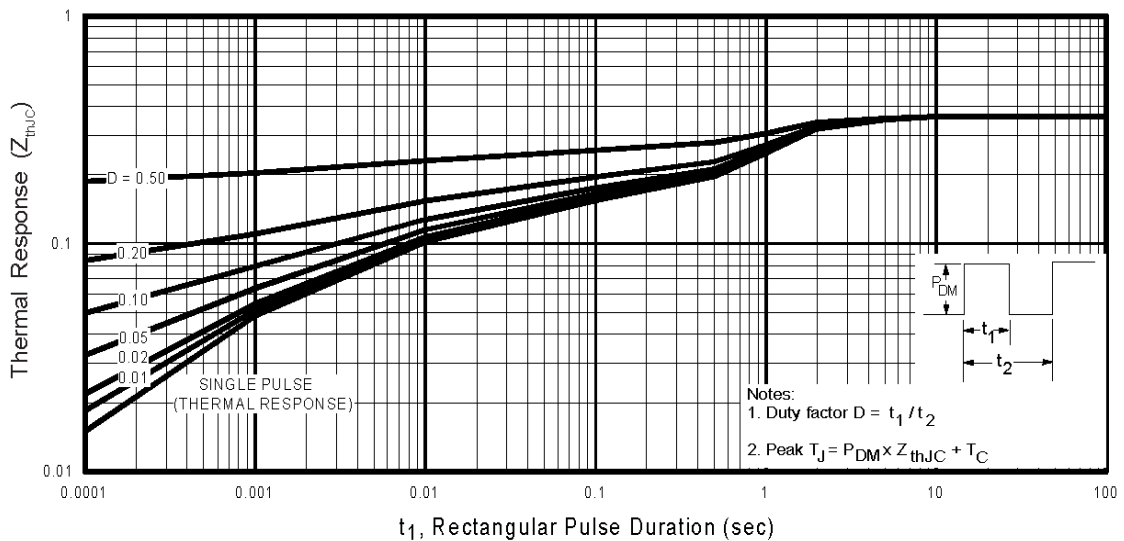

Fig. 6 - Maximum Effective Transient Thermal Impedance, Junction-to-Case

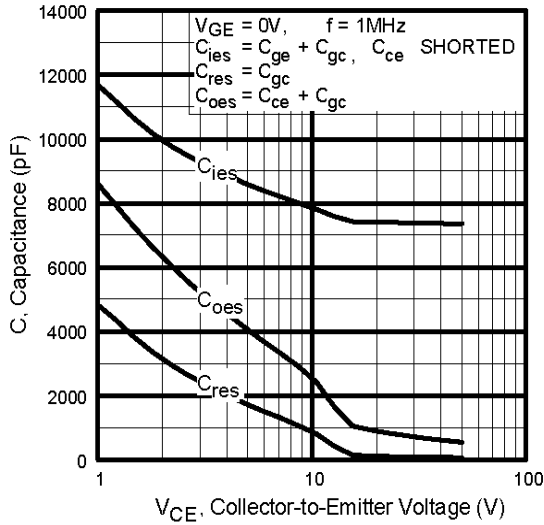

Fig. 7 - Typical Capacitance vs. Collector-to-Emitter Voltage

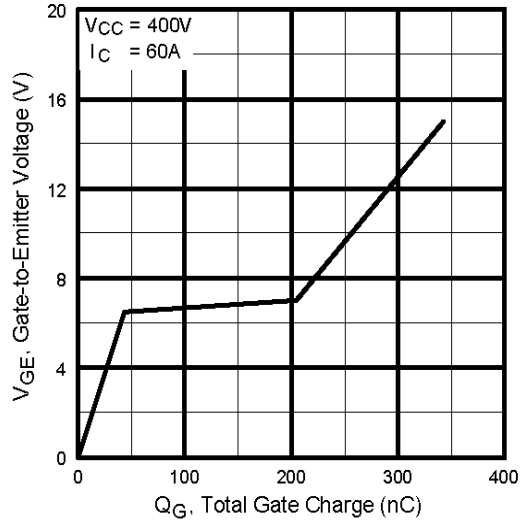

Fig. 8 - Typical Gate Charge vs. Gate-to-Emitter Voltage

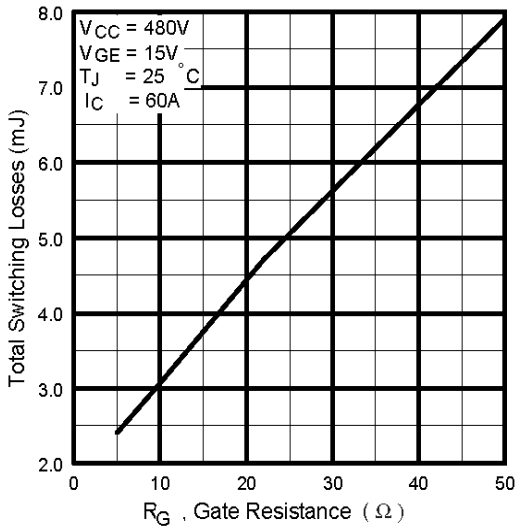

Fig. 9 - Typical Switching Losses vs. Gate Resistance

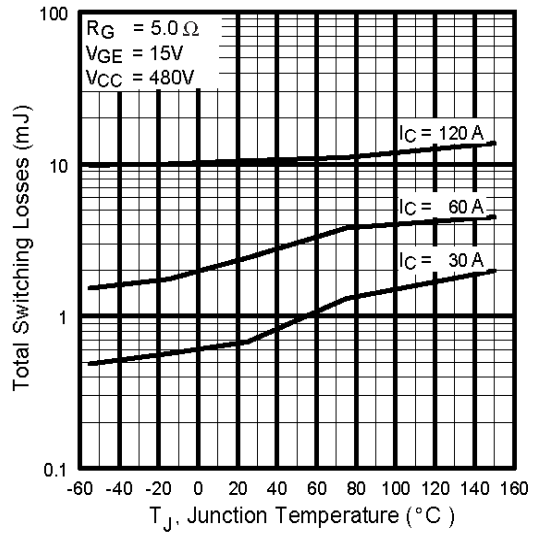

Fig. 10 - Typical Switching Losses vs. Junction Temperature

IRG4PSC71UPbF

International
IR Rectifier

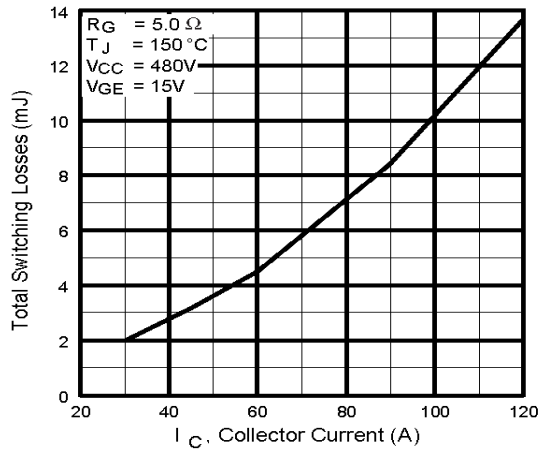

Fig. 11 - Typical Switching Losses vs. Collector-to-Emitter Current

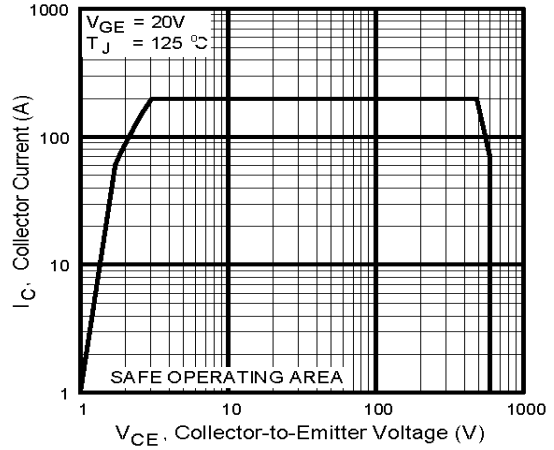
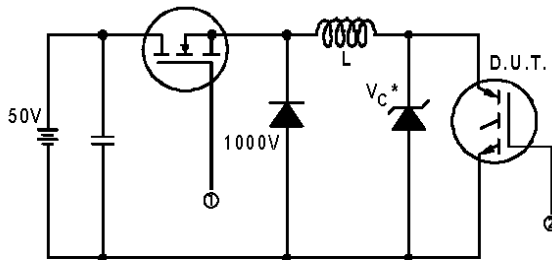

Fig. 12 - Turn-Off SOA



* Driver same type as D.U.T.; $V_c = 80\%$ of $V_{ce(max)}$
 * Note: Due to the 50V power supply, pulse width and inductor will increase to obtain rated I_d .

Fig. 13a - Clamped Inductive Load Test Circuit

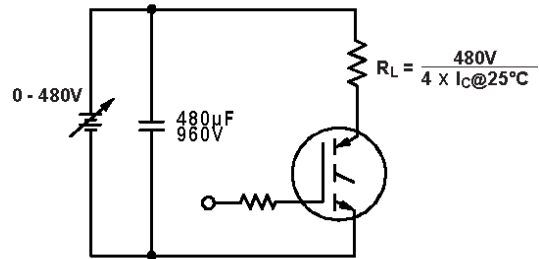

Fig. 13b - Pulsed Collector Current Test Circuit

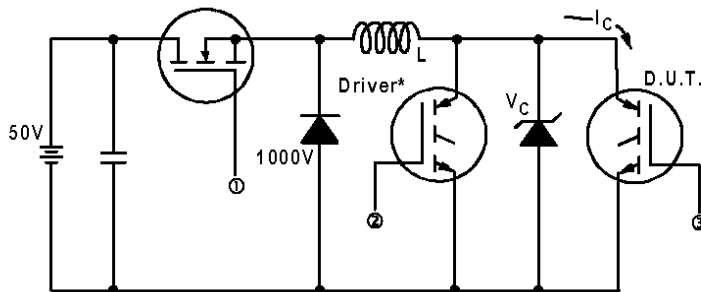

Fig. 14a - Switching Loss Test Circuit

* Driver same type as D.U.T., $V_c = 480V$

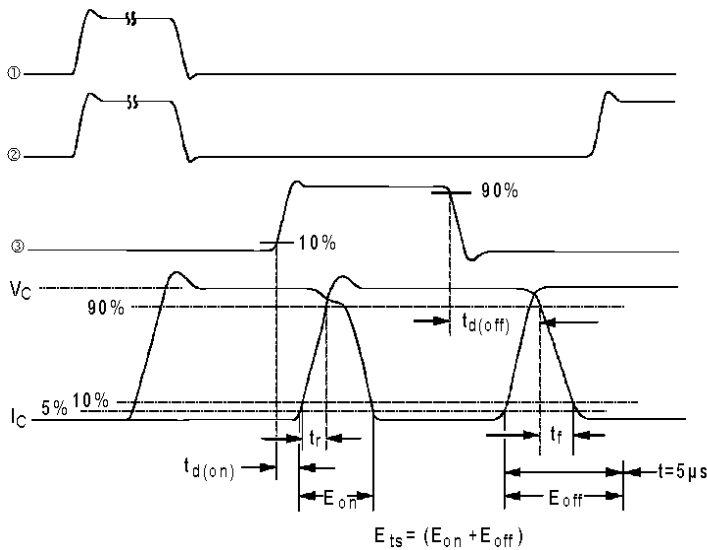
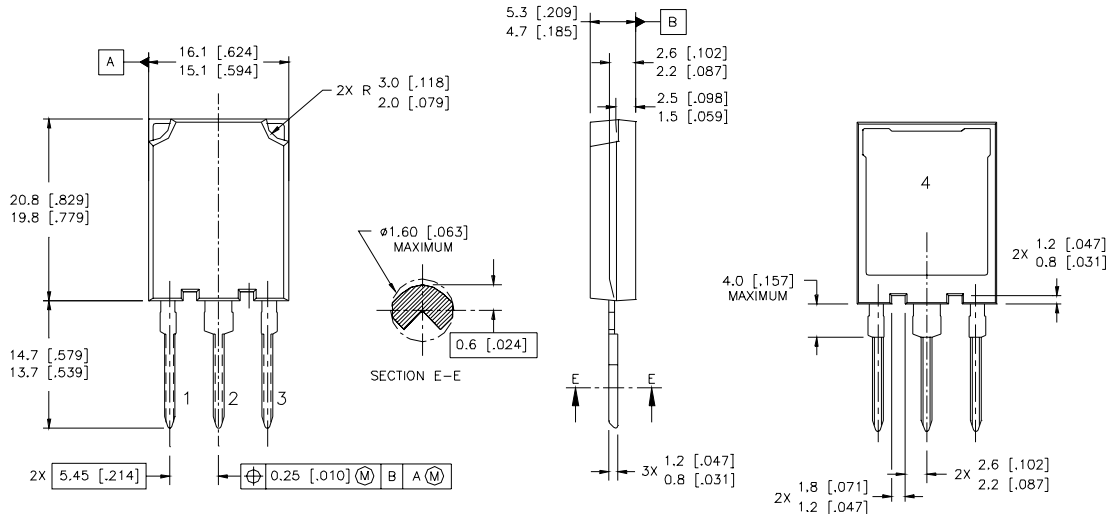

Fig. 14b - Switching Loss Waveforms

IRG4PSC71UPbF

International
IR Rectifier

Case Outline and Dimensions — Super-247



NOTES:

1. DIMENSIONS & TOLERANCING PER ASME Y14.5M-1994
2. CONTROLLING DIMENSION: MILLIMETER
3. DIMENSIONS ARE SHOWN IN MILLIMETRES [INCHES]

LEAD ASSIGNMENTS

| MOSFET | IGBT |
|------------|---------------|
| 1 - GATE | 1 - GATE |
| 2 - DRAIN | 2 - COLLECTOR |
| 3 - SOURCE | 3 - EMITTER |
| 4 - DRAIN | 4 - COLLECTOR |

Super-247 (TO-274AA) Part Marking Information

EXAMPLE: THIS IS AN IRFPS37N50A WITH
ASSEMBLY LOT CODE 1789
ASSEMBLED ON WW 19, 1997
IN THE ASSEMBLY LINE "C"

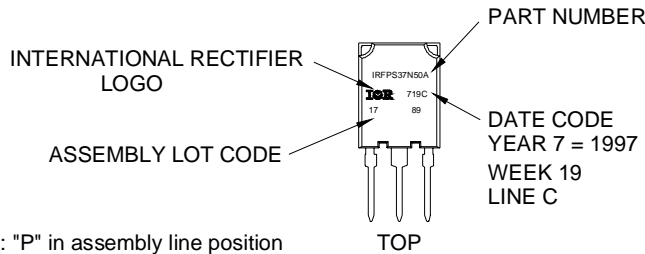

Note: "P" in assembly line position indicates "Lead-Free"

Data and specifications subject to change without notice.

International
IR Rectifier

IR WORLD HEADQUARTERS: 233 Kansas St., El Segundo, California 90245, USA Tel: (310) 252-7105
TAC Fax: (310) 252-7903

Visit us at www.irf.com for sales contact information. 09/04

www.irf.com