

## Data sheet

Commercial Art.No.: 25.642.3553.0

PCB pin header 8513 SUFK / 5 OB

PCB pin header with tension spring connection, 5 poles, max. cross section: 1.5 mm<sup>2</sup>, pitch: 3.5 mm, type of packing: carton, color: grey



Commercial Art.No.	25.642.3553.0
EAN	4015573554276
Order Unit	50

Certificates / Approvals



## Technical data

### General

Modular spacing	3.5 mm
Connection type	spring clamp connection
Soldering process	None
Packaging	Carton
Number of poles	5
Marking	No
Fastening	None
Mating direction towards connector	180°

### Technical data

Nominal cross section	1.5 mm <sup>2</sup>
Rated current	8 A
Overvoltage Category I	690 V
Overvoltage Category II	250 V
Overvoltage Category III	125
Rated impulse voltage	2.5 kV
Wire strip length	8 mm

### Connection Data

Minimum cross section solid	0.14 mm <sup>2</sup>
Maximum cross section solid	1.5 mm <sup>2</sup>
Minimum cross section fine stranded	0.14 mm <sup>2</sup>
Maximum cross section fine stranded	1.5 mm <sup>2</sup>
Wire strip length	8 mm

### Technical Data UL/CSA

Cross section UL	30-16 AWG
------------------	-----------

Voltage UL	300 V
Current field wiring	8 A
Current factory wiring	8 A
Cross section CSA	22-14 AWG
Voltage CSA	300 V
Current CSA	5 A

#### Other

Type of insulation material	Thermoplastic
Color	Grey
Height	12.4 mm
Length	18.9 mm
Depth	19.8 mm
Material attachment screw	None
Material contact base	Steel
Material contact surface	Sn

#### Classification

ECLASS 11	
ECLASS 8.1	27440402
ETIM 7.0	EC002637
ETIM 6.0	EC002637
ETIM 5.0	EC002637
ETIM 4.0	EC002637

#### Product compliance

ROHS conformity status	Compliant
REACH-SVHC conformity status	Compliant

#### Fits with

Commercial Art.No.:	Article-type description:	Description:
25.630.3553.0	PCB connector 8513 BFK / 5 TOP OB	PCB female connector with tension spring connection, 5 poles, max. cross section: 1.5 mm <sup>2</sup> , pitch: 3.5 mm, type of packing: carton, color: grey
25.630.0553.0	PCB connector 8513 BFK / 5 TOP	PCB female connector with tension spring connection, 5 poles, printed version, max. cross section: 1.5 mm <sup>2</sup> , pitch: 3.5 mm, type of packing: carton, color: grey

für folgende Tabellen-Zchnng.:  
25.642.3253.0 8513 SUFK/ ...OB

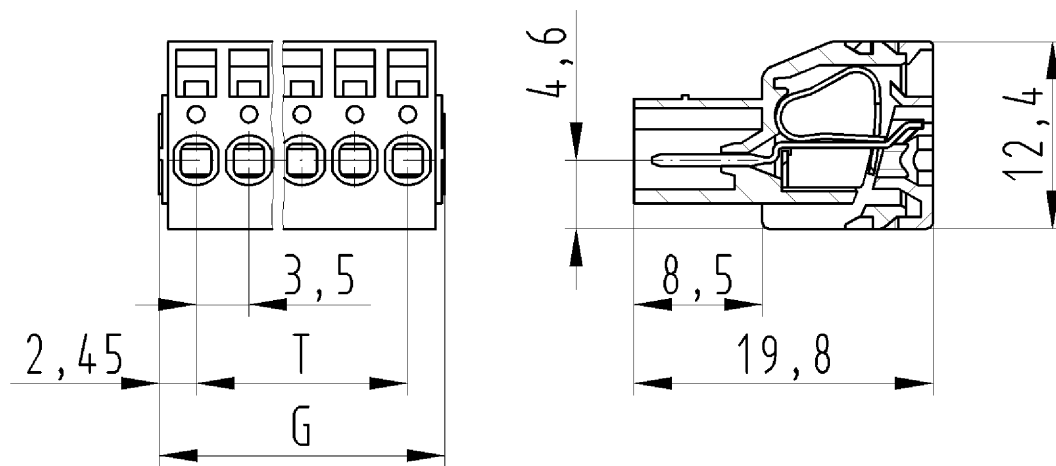

LP-Steckklemme  
25.642.3253.0 10W  
22.10.2007 DÜT  
M 2:1