

REV.	DESCRIPTION	DRAWN	CHECKED	APPROVED
A	NEW RELEASE	LJC 02/07/09'	~	LJC 02/07/09'
B	整理图画	YCH 08/18/09'	~	LJC 08/18/09'
C	DRAWING UPDATE	JLZ 06/21/17'	~	

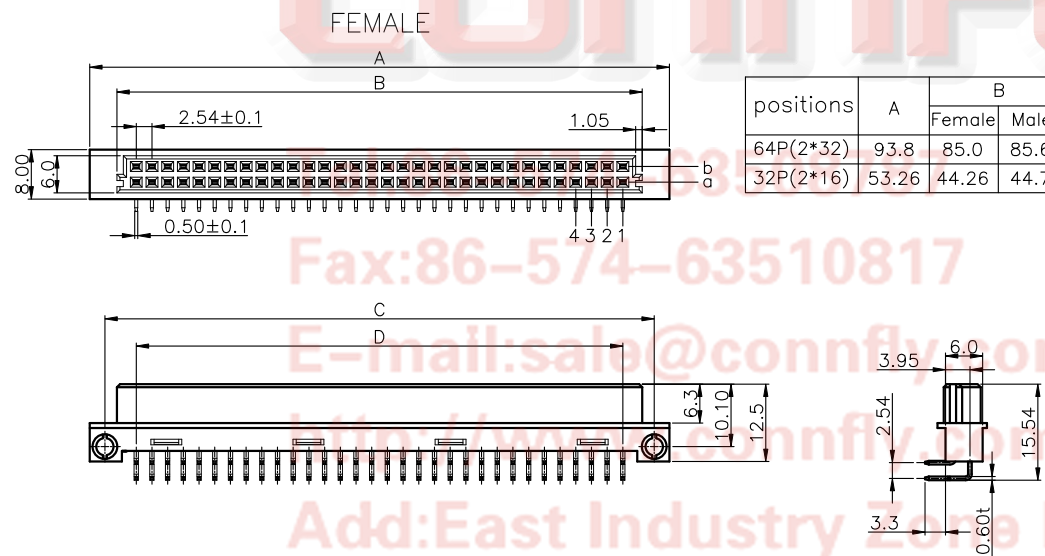
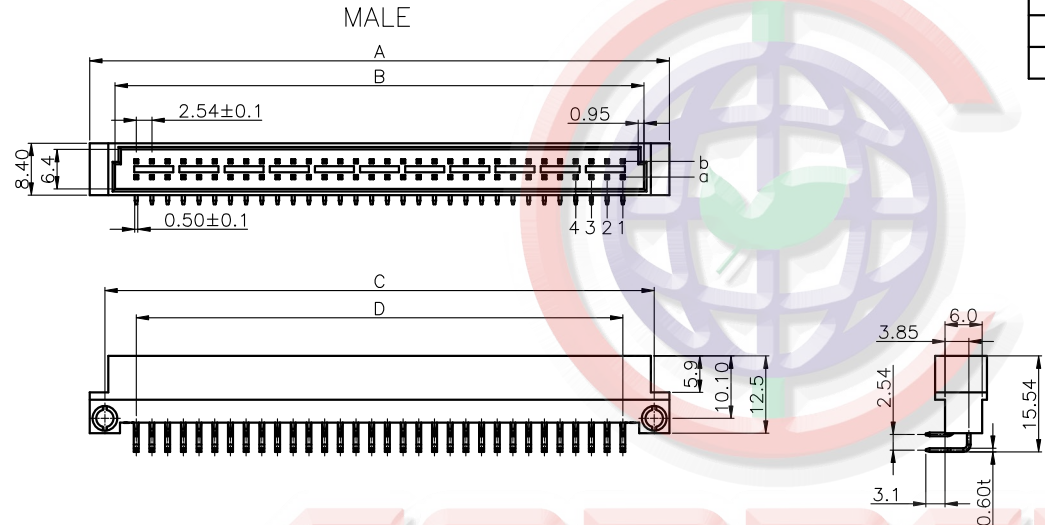

positions	A	B		C	D
		Female	Male		
64P(2*32)	93.8	85.0	85.6	88.9	78.74
32P(2*16)	53.26	44.26	44.7	48.26	38.10

NOTES:

- Specifications:
 - Contact Resistance: 20mΩ max.
 - Insulation Resistance: 1000MΩ min.
 - Current Rating: 2A.
 - Dielectric withstanding voltage: AC 1000V(r.m.s)/60s.
 - Operating Temperature: -40°C to +105°C
 - Recommend Wave Soldering Temperature: 260°C,5-10s.

- Materials:
 - Contact: Copper alloy
 - Housing: Thermoplastic(UL94 V-0)

3. Product Number code:

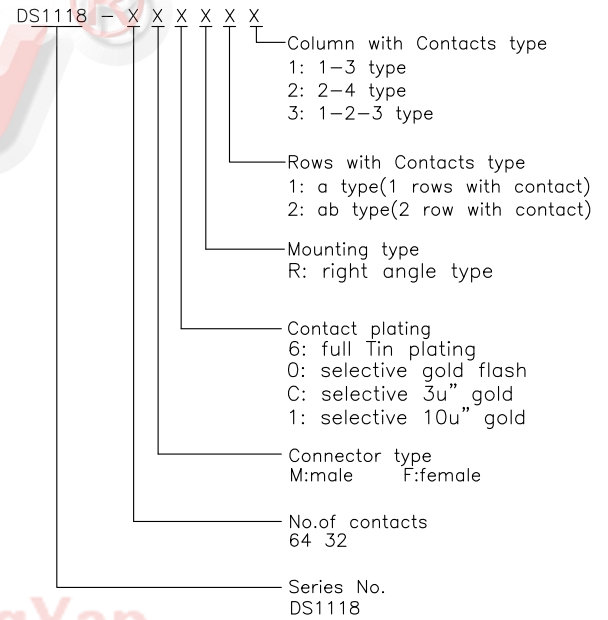

Fax:86-574-63510817
 E-mail:sale@connfly.com
 http://www.connfly.com
 Add:East Industry Zone, KuangYan
 Town, Ningbo City, Zhejiang
 P.C.315333

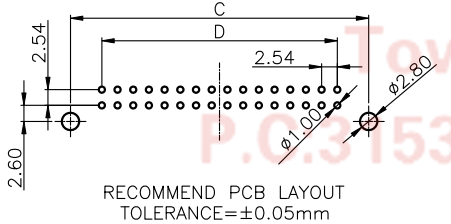

GENERAL TOLERANCE		ANGLE TOLERANCE	
.X	±0.60	.X	±5°
.X	±0.38	.X	±3°
.XX	±0.25	.XX	±2°

PROJECTION	TITLE	DIN 41612 B TYPE(2ROW) Right Angle	
mm		SERIES	DS1118 SERIES

DRAWING TYPE	CUSTOMER		
SCALE	1:1	SHEET	1 OF 3
DRAWING NO.	C-DS1118-XXXXRXX-C		

晨翔电子有限公司
CONNFLY CONNFLY ELECTRONIC CO. LTD

REV.	DESCRIPTION	DRAWN	CHECKED	APPROVED
A	NEW RELEASE	LJC 02/07/09'	~	LJC 02/07/09'
B	整理图面	YCH 08/18/09'	~	LJC 08/18/09'
C	DRAWING UPDATE	JLZ 06/21/17'	~	

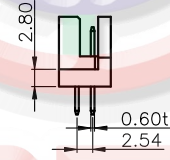
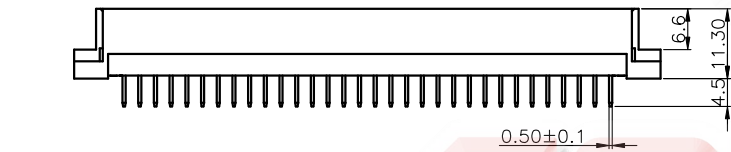
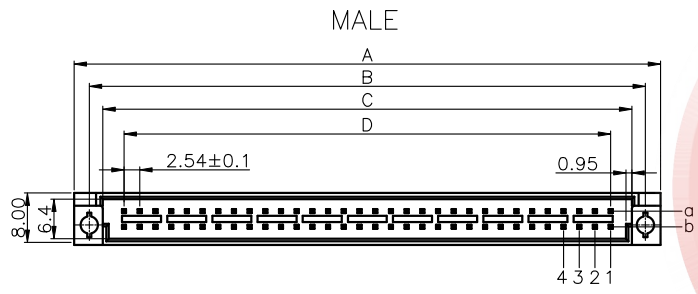

FEMALE

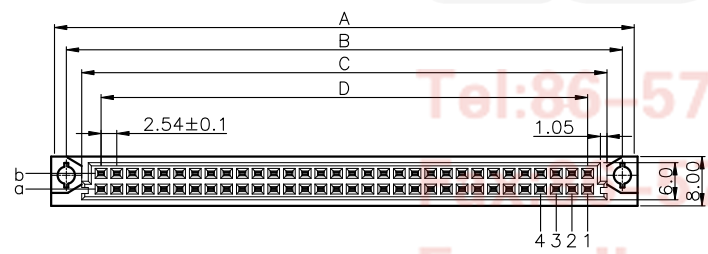

positions	A	B	C		D
			Female	Male	
64P(2*32)	94.9	90.0	85.0	85.6	78.74
32P(2*16)	54.9	50.0	44.26	44.7	38.10

NOTES:

- Specifications:
 - Contact Resistance: 20mΩ max.
 - Insulation Resistance: 1000MΩ min.
 - Current Rating: 2A.
 - Dielectric withstanding voltage: AC 1000V(r.m.s)/60s.
 - Operating Temperature: -40°C to +105°C
 - Recommend Wave Soldering Temperature: 260°C,5-10s.

2. Materials:

- Contact: Copper alloy
- Housing: Thermoplastic(UL94 V-0)

3. Product Number code:

DS1118 - X X X X X X - X

- Tail Length(Dim H,For Female)
S: H=2.9mm
N/A Code: H=4.5mm
- Column with Contacts type
1: 1-3 type
2: 2-4 type
3: 1-2-3 type
- Rows with Contacts type
1: a type(1 rows with contact)
2: ab type(2 row with contact)
- Mounting type
V: Vertical type
- Contact plating
6: full Tin plating
0: selective gold flash
C: selective 3u" gold
1: selective 10u" gold
- Connector type
M: male F: female
- No. of contacts
64 32

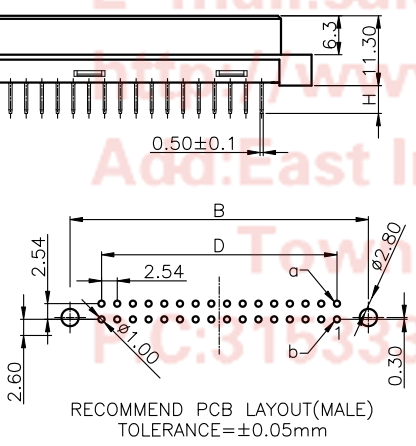
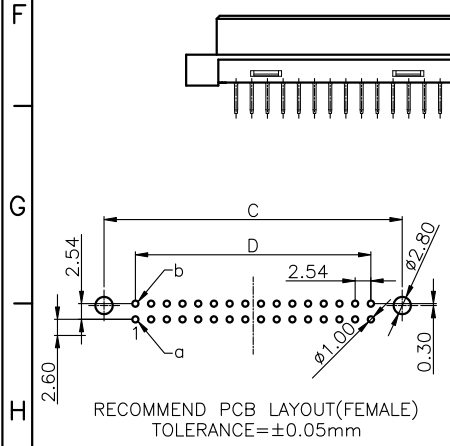

GENERAL TOLERANCE		ANGLE TOLERANCE	
X.	±0.60	X.	±5°
.X	±0.38	.X	±3°
.XX	±0.25	.XX	±2°

PROJECTION	TITLE	DIN 41612 B TYPE(2ROW) Vertical Through	
mm		SHEET	DS1118 SERIES
A4		SHEET	2 OF 3



晨翔电子有限公司
CONNFLY CONNFLY ELECTRONIC CO. LTD

CONNFLY

Tel: 86-574-63510817
E-mail: sale@connfly.com
www.connfly.com
Add: East Industry Zone Kuang Yan

REV.	DESCRIPTION	DRAWN	CHECKED	APPROVED
A	NEW RELEASE	LJC 02/07/09'	~	LJC 02/07/09'
C	DRAWING UPDATE	JLZ 06/21/17'	~	

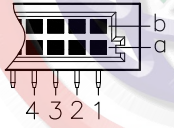
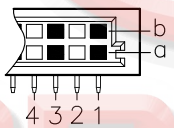
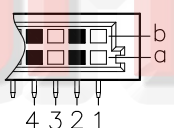
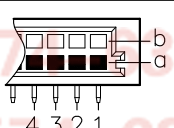
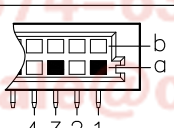
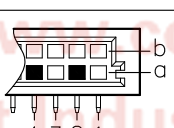
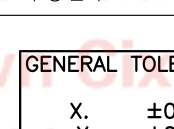
Reference to female R/A type

Pitch	Position	Row with conctacts	column with conctacts	Contact Arrange
2.54	64 (2*32)	ab	1-2-3	
		ab	1-3	
		ab	2-4	
		a	1-2-3	
		a	1-3	
		a	1-3	
		a	2-4	

Reference to female R/A type

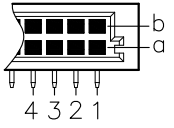
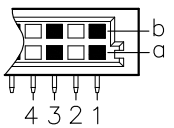
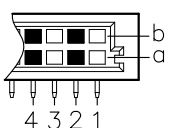
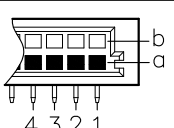
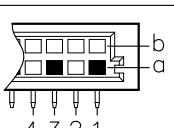
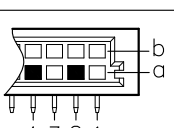
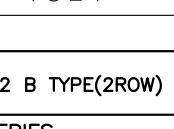
Pitch	Position	Row with conctacts	column with conctacts	Contact Arrange
2.54	32 (2*16)	ab	1-2-3	
		ab	1-3	
		ab	2-4	
		a	1-2-3	
		a	1-3	
		a	1-3	
		a	2-4	

GENERAL TOLERANCE		ANGLE TOLERANCE	
X.	±0.60	X.	±5°
.X	±0.38	.X	±3°
.XX	±0.25	.XX	±2°

PROJECTION	TITLE
	DIN 41612 B TYPE(2ROW)
UNITS	mm
SHEET SIZE	A4
SERIES	DS1118 SERIES

DRAWING TYPE	CUSTOMER		
SCALE	1:1	SHEET	3 OF 3
DRAWING NO.	C-DS1118-XXXXXXX-C		

晨翔电子有限公司
CONNFLY CONNFLY ELECTRONIC CO. LTD