

WDD20U SERIES

DC - DC CONVERTER
20W SINGLE & DUAL OUTPUT



FEATURES

- EFFICIENCY UP TO 89%
- 2:1 & 4:1 WIDE INPUT RANGE
- I/O ISOLATION
- INPUT Pi FILTER
- SHORT CIRCUIT PROTECTION
- HIGH PERFORMANCE
- 3 YEARS WARRANTY



EN 60950-1

MODEL LIST

MODEL NO.	INPUT VOLTAGE	INPUT CURRENT (typ.) (max.)		OUTPUT WATTAGE	OUTPUT VOLTAGE	OUTPUT CURRENT	EFF. (min.)	EFF. (typ.)	CAPACITOR LOAD (max.)
Single Output Models									
WDD20 - 03S1U	9~18 VDC	2.04 A	2.83 A	20 WATTS	+3.3 VDC	6000 mA	79%	81%	7000 μ F
WDD20 - 05S1U	9~18 VDC	1.98 A	2.72 A	20 WATTS	+ 5 VDC	4000 mA	83%	85%	7000 μ F
WDD20 - 12S1U	9~18 VDC	1.97 A	2.75 A	20 WATTS	+ 12 VDC	1670 mA	82%	84%	1000 μ F
WDD20 - 15S1U	9~18 VDC	1.96 A	2.72 A	20 WATTS	+ 15 VDC	1330 mA	83%	85%	470 μ F
WDD20 - 03S2U	18~36 VDC	1.0 A	1.4 A	20 WATTS	+3.3 VDC	6000 mA	80%	82%	7000 μ F
WDD20 - 05S2U	18~36 VDC	0.97 A	1.4 A	20 WATTS	+ 5 VDC	4000 mA	84%	86%	7000 μ F
WDD20 - 12S2U	18~36 VDC	0.96 A	1.32 A	20 WATTS	+ 12 VDC	1670 mA	86%	88%	1000 μ F
WDD20 - 15S2U	18~36 VDC	0.95 A	1.32 A	20 WATTS	+ 15 VDC	1330 mA	87%	89%	470 μ F
WDD20 - 03S3U	35~75 VDC	0.5 A	0.71 A	20 WATTS	+3.3 VDC	6000 mA	81%	83%	7000 μ F
WDD20 - 05S3U	35~75 VDC	0.49 A	0.71 A	20 WATTS	+ 5 VDC	4000 mA	82%	84%	7000 μ F
WDD20 - 12S3U	35~75 VDC	0.48 A	0.7 A	20 WATTS	+ 12 VDC	1670 mA	86%	88%	1000 μ F
WDD20 - 15S3U	35~75 VDC	0.47 A	0.7 A	20 WATTS	+ 15 VDC	1330 mA	87%	89%	470 μ F
WDD20 - 03S4U	9~36 VDC	1.06 A	2.88 A	20 WATTS	+3.3 VDC	6000 mA	77%	79%	7000 μ F
WDD20 - 05S4U	9~36 VDC	1.06 A	2.88 A	20 WATTS	+ 5 VDC	4000 mA	78%	80%	3500 μ F
WDD20 - 12S4U	9~36 VDC	1.03 A	2.8 A	20 WATTS	+ 12 VDC	1670 mA	80%	82%	470 μ F
WDD20 - 15S4U	9~36 VDC	1.02 A	2.8 A	20 WATTS	+ 15 VDC	1330 mA	81%	83%	220 μ F
WDD20 - 03S5U	18~75 VDC	0.53 A	1.45 A	20 WATTS	+3.3 VDC	6000 mA	77%	79%	7000 μ F
WDD20 - 05S5U	18~75 VDC	0.51 A	1.45 A	20 WATTS	+ 5 VDC	4000 mA	79%	81%	3500 μ F
WDD20 - 12S5U	18~75 VDC	0.5 A	1.4 A	20 WATTS	+ 12 VDC	1670 mA	82%	84%	3500 μ F
WDD20 - 15S5U	18~75 VDC	0.5 A	1.4 A	20 WATTS	+ 15 VDC	1330 mA	82%	84%	1000 μ F
Dual Output Models									
WDD20 - 05D1U	9~18 VDC	2.0 A	2.75 A	20 WATTS	\pm 5 VDC	\pm 2000 mA	82%	84%	\pm 1000 μ F
WDD20 - 12D1U	9~18 VDC	1.93 A	2.72 A	20 WATTS	\pm 12 VDC	\pm 830 mA	83%	85%	\pm 470 μ F
WDD20 - 15D1U	9~18 VDC	1.93 A	2.72 A	20 WATTS	\pm 15 VDC	\pm 670 mA	84%	86%	\pm 470 μ F
WDD20 - 05D2U	18~36 VDC	0.98 A	1.4 A	20 WATTS	\pm 5 VDC	\pm 2000 mA	83%	85%	\pm 1000 μ F



WDD20U SERIES

SINGLE & DUAL OUTPUT

MODEL LIST

MODEL NO.	INPUT VOLTAGE	INPUT CURRENT (typ.) (max.)		OUTPUT WATTAGE	OUTPUT VOLTAGE	OUTPUT CURRENT	EFF. (min.)	EFF. (typ.)	CAPACITOR LOAD (max.)
Dual Output Models									
WDD20 - 12D2U	18~36 VDC	0.96 A	1.32 A	20 WATTS	± 12 VDC	± 830 mA	86%	88%	± 470 μF
WDD20 - 15D2U	18~36 VDC	0.95 A	1.32 A	20 WATTS	± 15 VDC	± 670 mA	87%	89%	± 470 μF
WDD20 - 05D3U	35~75 VDC	0.49 A	0.7 A	20 WATTS	± 5 VDC	± 2000 mA	83%	85%	±1000 μF
WDD20 - 12D3U	35~75 VDC	0.48 A	0.7 A	20 WATTS	± 12 VDC	± 830 mA	86%	88%	± 470 μF
WDD20 - 15D3U	35~75 VDC	0.48 A	0.7 A	20 WATTS	± 15 VDC	± 670 mA	87%	89%	± 470 μF
WDD20 - 05D4U	9~36 VDC	1.06 A	2.88 A	20 WATTS	± 5 VDC	± 2000 mA	78%	80%	±1000 μF
WDD20 - 12D4U	9~36 VDC	1.02 A	2.8 A	20 WATTS	± 12 VDC	± 830 mA	81%	83%	± 470 μF
WDD20 - 15D4U	9~36 VDC	1.0 A	2.8 A	20 WATTS	± 15 VDC	± 670 mA	82%	84%	± 470 μF
WDD20 - 05D5U	18~75 VDC	0.52 A	1.4 A	20 WATTS	± 5 VDC	± 2000 mA	80%	82%	±1000 μF
WDD20 - 12D5U	18~75 VDC	0.49 A	1.4 A	20 WATTS	± 12 VDC	± 830 mA	82%	84%	± 470 μF
WDD20 - 15D5U	18~75 VDC	0.5 A	1.4 A	20 WATTS	± 15 VDC	± 670 mA	82%	84%	± 470 μF

SPECIFICATION

All Specifications Typical At Nominal Line, Full Load, 25°C Unless Otherwise Noticed

GENERAL						
Characteristics	Conditions		min.	typ.	max.	unit
Switching frequency	Vi nom, Io nom			250		KHz
Isolation voltage	Input - Output		1,500			VDC
Isolation resistance	Input - Output, @ 500VDC		100			MΩ
Isolation capacitance	100KHz / 1V				1,000	PF
Ambient temperature	Vi nom,	3.3V & 5V output models	-40		+ 61	°C
	Io nom	12V, 15V & dual output models	-40		+ 71	°C
Case temperature	Operating at Vi nom, Io nom				+ 100	°C
Derating	Vi nom		See derating curve			
Storage temperature	Non operational		-40		+ 100	°C
Relative humidity	Vi nom, Io nom		20		95	% RH
Temperature coefficient	Vi nom, Io min				± 0.02	% / °C
Dimension			L50.8 x W40.64 x H10.16			mm
MTBF	Bellcore issue 6@40°C, GB			958,000		Hours
Cooling	Free air convection					

INPUT SPECIFICATIONS						
Characteristics	Conditions		min.	typ.	max.	unit
Input voltage range	Ta min ... Ta max, Io nom	2:1	9	12	18	VDC
			18	24	36	VDC
			35	48	75	VDC
		4:1	9	24	36	VDC
			18	48	75	VDC
No load input current	Vi nom, Io=0	12V		25	mA	
		24V		20	mA	
		48V		15	mA	
Input voltage w/o damage	Io nom	12V		20	VDC	
		24V		40	VDC	
		48V		80	VDC	
Startup voltage	Io nom	2:1	12V	8.5		VDC
			24V	16		VDC
			48V	33		VDC
		4:1	24V	8.5		VDC
			48V	16		VDC
Input filter	Pi type					

www.chinfa.com

sales@chinfa.com

2012.10.18



CHINFA ELECTRONICS IND. CO., LTD.
ISO 9001 Certified

P2

SPECIFICATION

All Specifications Typical At Nominal Line, Full Load, 25°C Unless Otherwise Noticed

OUTPUT SPECIFICATIONS

Characteristics	Conditions	min.	typ.	max.	unit
Output voltage accuracy	Vi nom, Io nom			± 2	%
Minimum load	Vi nom	0			%
		single output models			
		10			%
	dual output models (each output)				
Line regulation	Io nom, Vi min ... Vi max			± 1	%
Load regulation	Vi nom, Io 0 ... Io nom, single output models			± 2	%
	Vi nom, Io min ... Io nom, dual output models			± 5	%
Cross regulation (Dual model)	Aymmetrical load 10% - 100% FL			± 5	%
Startup time	Vi nom, Io nom			30	ms
Transient recovery time	Vi nom, I ~ 0.5 Io nom			500	μs
Ripple & noise	Vi nom, Io nom, BW = 20MHz	3.3V & 5V		100	mV
		12V, 15V & dual		150	mV
Voltage trim range (I)	Vi nom	3.3V	± 5		%
		5V, 12V, 15V & dual	± 10		%
Efficiency	Vi nom, Io nom, Po / Pi	Up to 89%, See model list and efficiency curve			

NOTE 1 : Pls refer to Fig 1 & Table 1 for connection and resistance recommended.

CONTROL AND PROTECTION

Remote ON / OFF	ON : opened or 8 ~ 10VDC applied, reference to input GND OFF : -0.3 ~ 2VDC applied, reference to input GND
Input reversed	Shunt diode built in, external fuse recommended 2:1 models (12Vin : 3A, 24Vin : 1.5A, 48Vin : 1A) 4:1 models (24Vin : 3A, 48Vin : 1.5A)
Output short circuit	Current limited (Auto-recovery)
Rated over load protection	110%min....140%max
UL/cUL	UL 60950-1 Recognized
TUV	EN 60950-1
CE	EN 61204-3, EN 55022, Class A, EN 61000-4-2, EN61000-4-3, EN61000-4-4, EN61000-4-6
Vibration	meet IEC 60068-2-6 (10-500 Hz, 2G, along X, Y, Z each Axis, 60 min for each Axis)

PHYSICAL CHARACTERISTICS

Case size	50.8 x 40.64 x 10.16 mm (2 x 1.6 x 0.4 inches)
Case material	Plastic base / Metal case
Weight	60 g
Potting material	Silicone

MECHANISM & PIN CONFIGURATION

mm [inch]

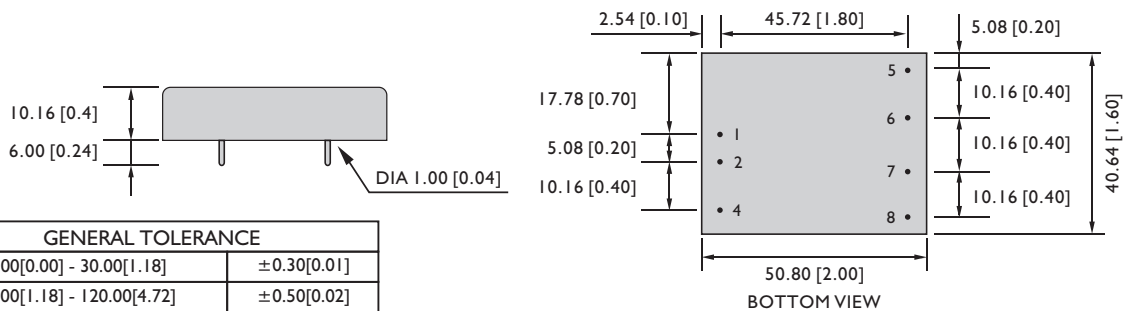

GENERAL TOLERANCE	
0.00[0.00] - 30.00[1.18]	±0.30[0.01]
30.00[1.18] - 120.00[4.72]	±0.50[0.02]

PIN ASSIGNMENT

GENERAL

PIN NO.	1	2	4	5	6	7	8
SINGLE	Vi +	Vi -	ON / OFF	NO PIN	Vo +	Vo -	Trim
DUAL	Vi +	Vi -	ON / OFF	Vo +	com	Vo -	Trim

CIRCUIT SCHEMATIC

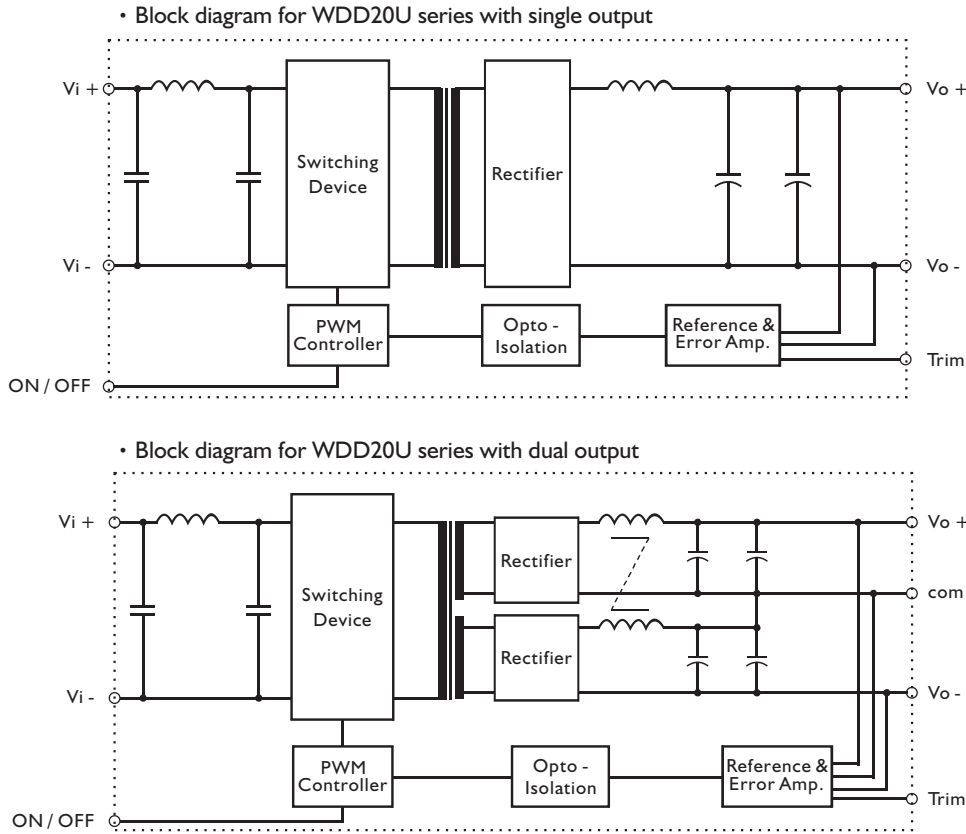

RECOMMENDED CIRCUIT

- Recommended filter for EN55022 Class B compliance

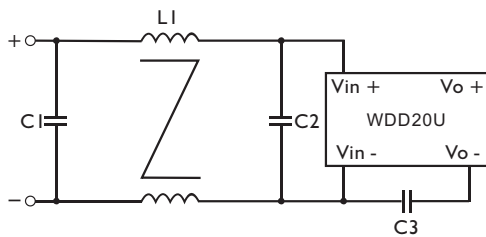

- Recommended EN 55022 Class B filter circuit layout.

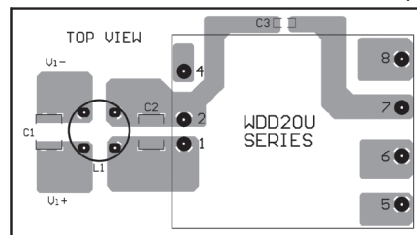

- The components used in the above figure, together with the manufacturer part numbers for these components, are as follows.

	C1	C2	C3	L1
WDD20-XXX1U	3.3 μ F / 50V MLCC	3.3 μ F / 50V MLCC	1nF / 2KV MLCC	1.5mH Common Choke
WDD20-XXX2U	1 μ F / 50V MLCC	1 μ F / 50V MLCC	1nF / 2KV MLCC	1.5mH Common Choke
WDD20-XXX3U	3.3 μ F / 100V MLCC	3.3 μ F / 100V MLCC	1nF / 2KV MLCC	0.5mH Common Choke
WDD20-XXX4U	1 μ F / 50V MLCC	1 μ F / 50V MLCC	1nF / 2KV MLCC	1.5mH Common Choke
WDD20-XXX5U	3.3 μ F / 100V MLCC	3.3 μ F / 100V MLCC	1nF / 2KV MLCC	0.5mH Common Choke

DERATING AND EFFICIENCY CURVE

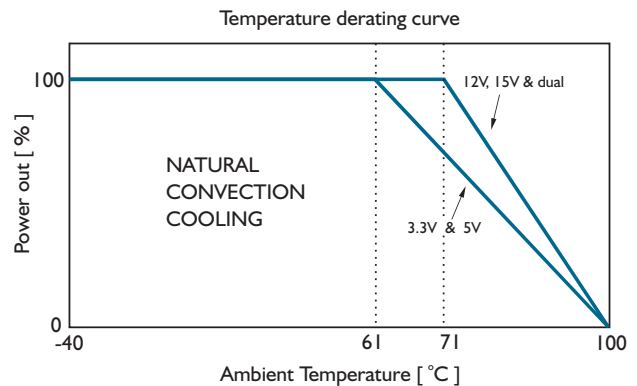

DERATING AND EFFICIENCY CURVE

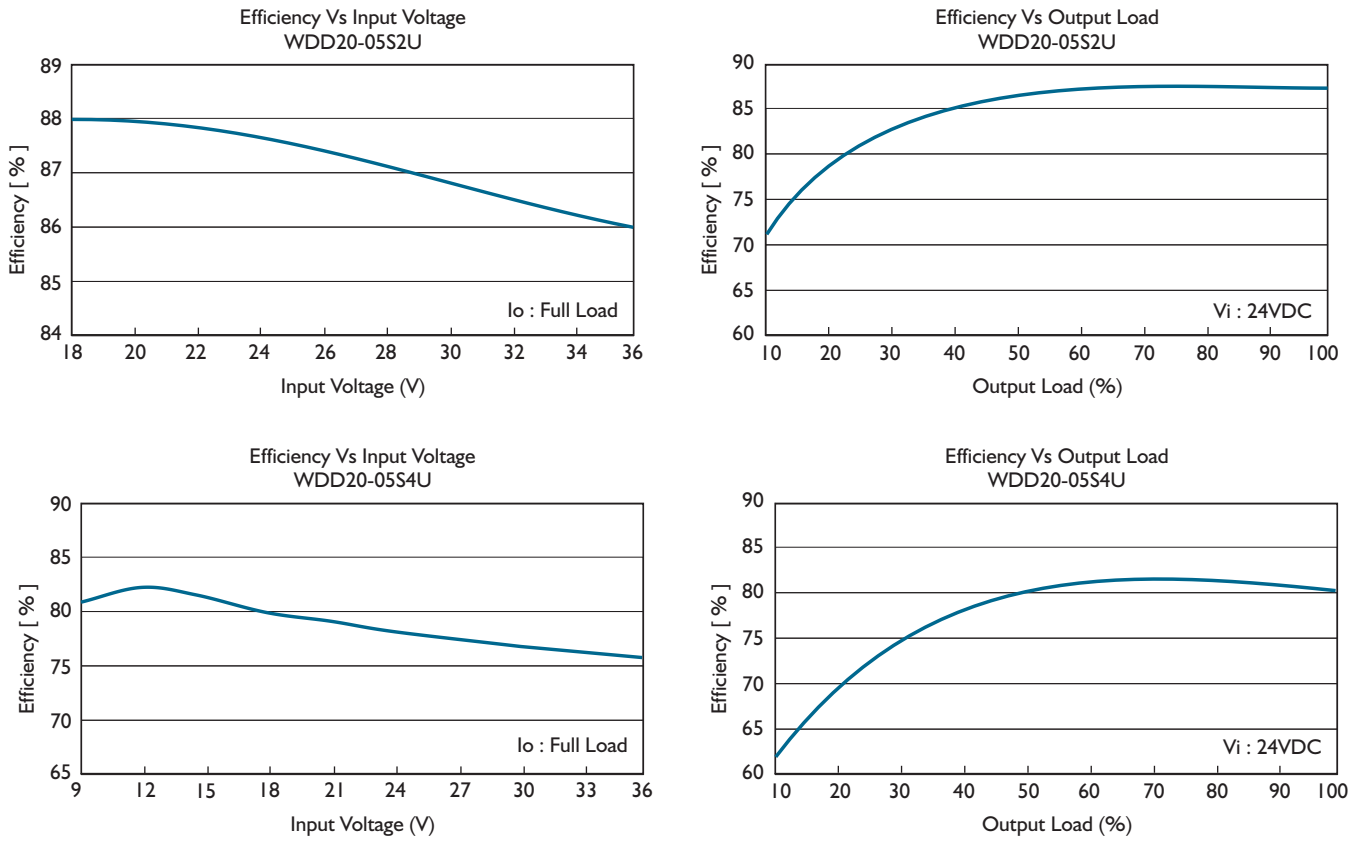
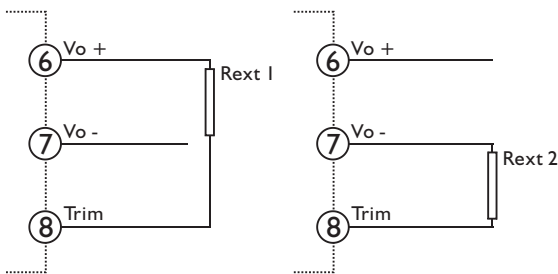

Fig. 1 Trim connection

(For Single output)



(For Dual output)

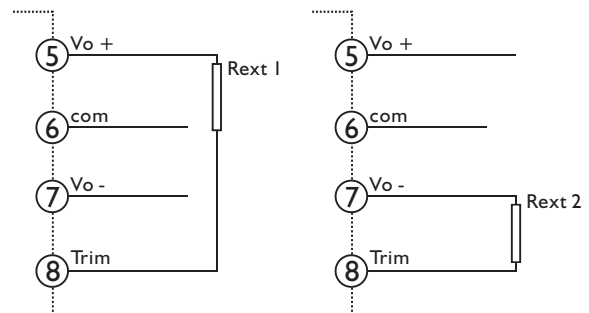

Table I Typical resistor values for various output voltage adjustment settings

Type	Rext 1		Rext 2	
	Vo nom -2.5%	Vo nom -5%	Vo nom +2.5%	Vo nom +5%
WDD20-03SXU	820Ω	0Ω	7.5KΩ	3KΩ
Type	Vo nom -5%	Vo nom -10%	Vo nom +5%	Vo nom +10%
WDD20-05SXU	3.9KΩ	0Ω	4.7KΩ	0Ω
WDD20-12SXU	130KΩ	18KΩ	10KΩ	1KΩ
WDD20-15SXU	130KΩ	20KΩ	20KΩ	3.9KΩ
WDD20-05DXU	33KΩ	12KΩ	10KΩ	3KΩ
WDD20-12DXU	120KΩ	56KΩ	12KΩ	2KΩ
WDD20-15DXU	180KΩ	75KΩ	10KΩ	1.2KΩ