

Data sheet

Commercial Art.No.: 99.235.9996.1

PCB pin header 8213 S / 5 G OB OF

PCB pin header, connection method depends on used socket part , 5 poles, pitch: 5.08 mm, type of packing: carton, color: black



Commercial Art.No.	99.235.9996.1
EAN	4015573283657
Order Unit	50

Certificates / Approvals



Technical data

General

Modular spacing	5.08 mm
Soldering process	Wave soldering
Packaging	Carton
Number of poles	5
Number of levels	1
Marking	No
Fastening	None
Mating direction towards (circuit) board	90°

Technical data

Rated current	12 A
Overvoltage Category I	1000 V
Overvoltage Category II	400 V
Overvoltage Category III	250 V
Rated impulse voltage	4 kV

Technical Data UL/CSA

Voltage UL	300 V
Current field wiring	15 A
Current factory wiring	15 A
Voltage CSA	300 V
Current CSA	15 A

Other

Type of insulation material	Thermoplastic
Color	Grey
Height	12 mm

Length	25.4 mm
Depth	8.4 mm
Material contact base	CuZn
Material contact surface	Sn

Classification

ECLASS 11	
ECLASS 8.1	27440402
ETIM 7.0	EC002637
ETIM 6.0	EC002637
ETIM 5.0	EC002637
ETIM 4.0	EC002637

Product compliance

ROHS conformity status	Compliant
REACH-SVHC conformity status	Compliant

Fits with

Commercial Art.No.:	Article-type description:	Description:
25.240.3553.0	PCB connector 8213 B / 5 TOP OB	PCB female connector with front/top screw connection, 5 poles, max. cross section: 2.5 mm ² , pitch: 5.08 mm, type of packing: carton, color: grey
25.240.0553.0	PCB connector 8213 B / 5 TOP	PCB female connector with front/top screw connection, 5 poles, printed version, max. cross section: 2.5 mm ² , pitch: 5.08 mm, type of packing: carton, color: grey
25.340.3553.0	PCB connector 8213 B / 5 OB	PCB female connector with screw connection with rising cage clamp system, 5 poles, max. cross section: 2.5 mm ² , pitch: 5.08 mm, type of packing: carton, color: grey
25.340.0553.0	PCB connector 8213 B / 5	PCB female connector with screw connection with rising cage clamp system, 5 poles, printed version, max. cross section: 2.5 mm ² , pitch: 5.08 mm, type of packing: carton, color: grey
25.345.3553.0	PCB connector 8213 B / 5 VR OB	PCB female connector with screw connection with rising cage clamp system, 5 poles, max. cross section: 2.5 mm ² , pitch: 5.08 mm, type of packing: carton, color: grey
25.345.0553.0	PCB connector 8213 B / 5 VR	PCB female connector with screw connection with rising cage clamp system, 5 poles, printed version, max. cross section: 2.5 mm ² , pitch: 5.08 mm, type of packing: carton, color: grey
25.346.3553.0	PCB connector 8213 B / 5 VL OB	PCB female connector with screw connection with rising cage clamp system, 5 poles, max. cross section: 2.5 mm ² , pitch: 5.08 mm, type of packing: carton, color: grey
25.346.0553.0	PCB connector 8213 B / 5 VL	PCB female connector with screw connection with rising cage clamp system, 5 poles, printed version, max. cross section: 2.5 mm ² , pitch: 5.08 mm, type of packing: carton, color: grey
27.341.3553.0	PCB connector 8213 B / 5 S OB	PCB female connector, 5 poles, pitch: 5.08 mm, type of packing: carton, color: grey
25.840.3553.0	PCB connector 8213 BFK / 5 TOP OB	PCB female connector with tension spring connection, 5 poles, max. cross section: 2.5 mm ² , pitch: 5.08 mm, type of packing: carton, color: grey
25.840.0553.0	PCB connector 8213 BFK / 5 TOP	PCB female connector with tension spring connection, 5 poles, printed version, max. cross section: 2.5 mm ² , pitch: 5.08 mm, type of packing: carton, color: grey

25.343.3553.0	PCB connector 8213 BL / 5 W OB	PCB female connector with pin header, connection method depends on usedsocket part , 5 poles, pitch: 5.08 mm, type of packing: carton, color: grey
25.343.0553.0	PCB connector 8213 BL / 5 W	PCB female connector with pin header, connection method depends on usedsocket part , 5 poles, printed version, pitch: 5.08 mm, type of packing: carton, color: grey
25.342.3553.0	PCB connector 8213 BL / 5 G OB	PCB female connector with pin header, connection method depends on usedsocket part , 5 poles, pitch: 5.08 mm, type of packing: carton, color: grey
25.342.0553.0	PCB connector 8213 BL / 5 G	PCB female connector with pin header, connection method depends on usedsocket part , 5 poles, printed version, pitch: 5.08 mm, type of packing: carton, color: grey

für folgende Tabellen-Zchnng.:
99.232.9996.1 8213 S/...GOF

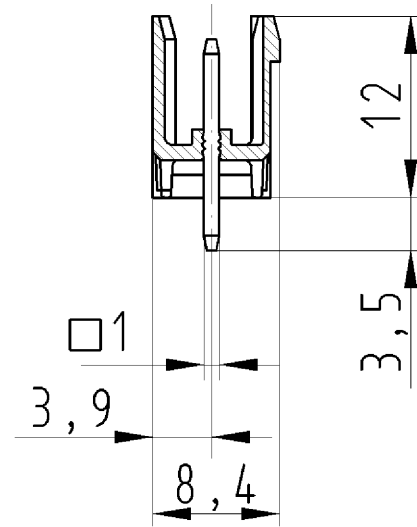
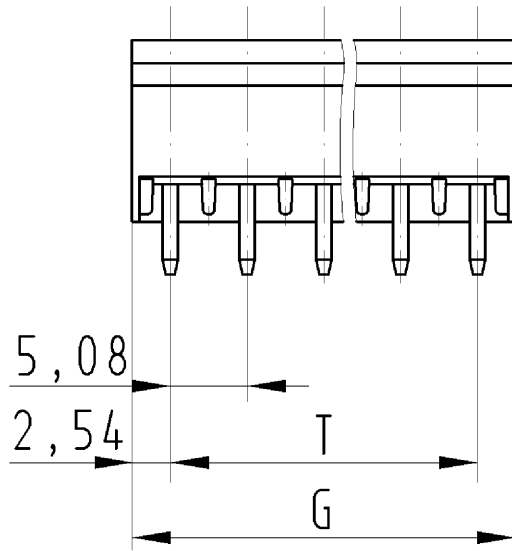

LP.STIFTLLEISTE
99.232.9996.1 10W
05.11.2007 SCJ
M 2:1