



Technical Data Sheet

1.5mm Side Looking Phototransistor

PT908-7C-F

Features

- Fast response time
- High sensitivity
- Small junction capacitance
- Pb Free
- This product itself will remain within RoHS compliant version.



Descriptions

PT908-7C-F is a phototransistor in miniature package which is molded in a water clear plastic with spherical top view lens. The device is spectrally matched to infrared emitting diode.

Applications

- Optoelectronic switch
- VCR , Video Camera
- Floppy disk drive
- Infrared applied system

Device Selection Guide

LED Part No.	Chip	Lens Color
	Material	
PT908-7C-F	Silicon	Water Clear

Package Dimensions

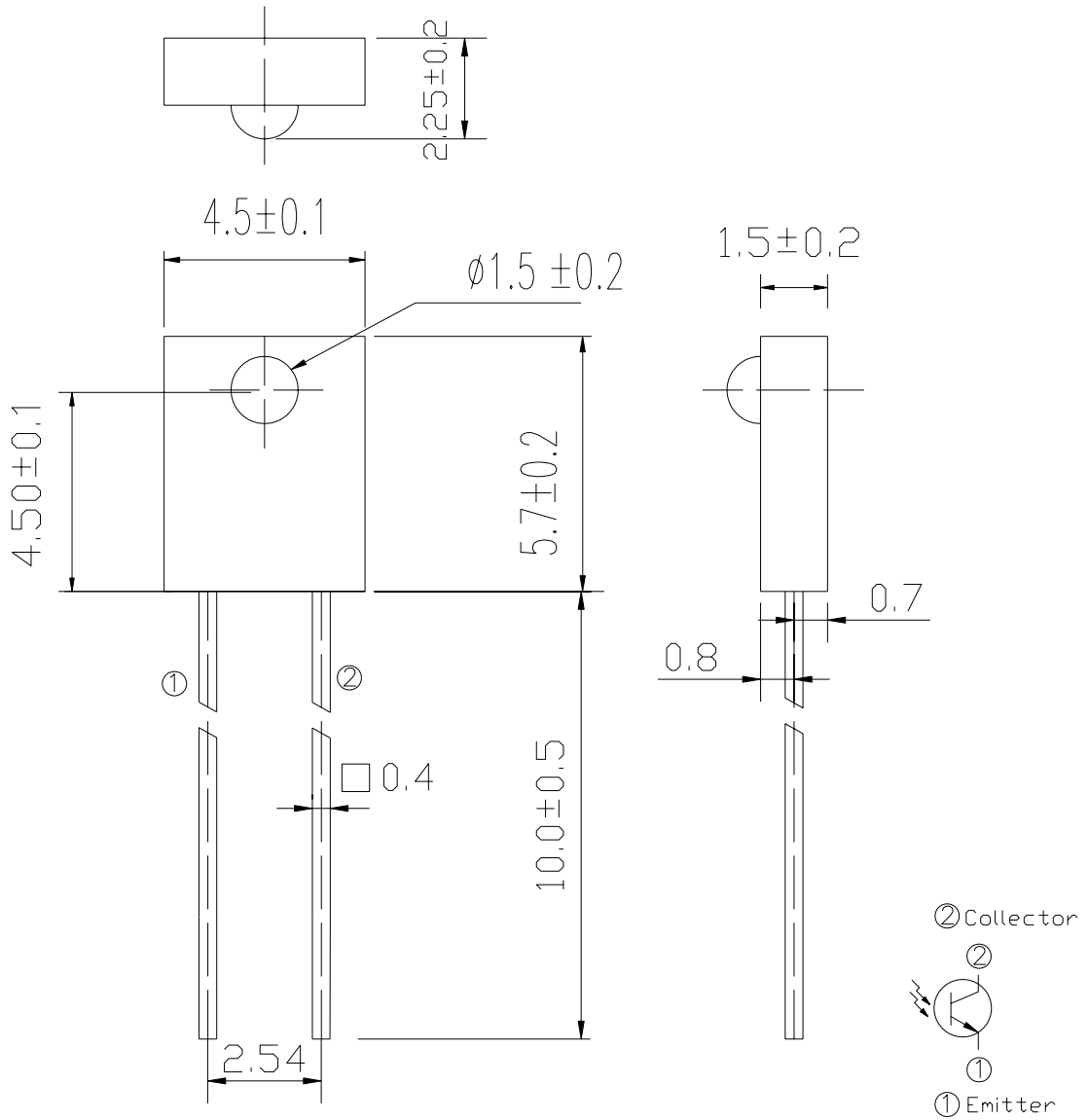

- Notes:**
1. All dimensions are in millimeters
 2. Tolerances unless dimensions ± 0.15 mm

Absolute Maximum Ratings (Ta=25°C)

Parameter	Symbol	Rating	Units
Collector-Emitter Voltage	V _{CEO}	30	V
Emitter-Collector-Voltage	V _{ECO}	5	V
Collector Current	I _C	20	mA
Operating Temperature	T _{opr}	-25 ~ +85°C	°C
Storage Temperature	T _{stg}	-40 ~ +100°C	°C
Lead Soldering Temperature	T _{sol}	260	°C
Power Dissipation at (or below) 25°C Free Air Temperature	PD	75	mW

Notes: *1:Soldering time ≤ 5 seconds.

Electro-Optical Characteristics (Ta=25°C)

Parameter	Symbol	Condition	Min.	Typ.	Max.	Units
Collector – Emitter Breakdown Voltage	BV _{CEO}	I _C =100 μA Ee=0mW/cm ²	30	---	---	V
Emitter-Collector Breakdown Voltage	BV _{ECO}	I _E =100 μA Ee=0mW/cm ²	5	---	---	V
Collector-Emitter Saturation Voltage	V _{CE(sat)}	I _C =2mA Ee=1mW/cm ²	---	---	0.4	V
Rise Time	t _r	V _{CE} =5V I _C =1mA	---	15	---	μS
Fall Time	t _f	RL=1000 Ω	---	15	---	
Collector Dark Current	I _{CEO}	Ee=0mW/cm ² V _{CE} =20V	---	---	100	nA
On State Collector Current	I _{C(on)}	Ee=0.555mW/cm ² V _{CE} =5V	0.80		5.0	mA
Wavelength of Peak Sensitivity	λ _p	---	---	940	---	nm
Rang of Spectral Bandwidth	λ _{0.5}	---	400	---	1100	nm

Typical Electro-Optical Characteristics Curves

Fig.1 Collector Power Dissipation vs. Ambient Temperature

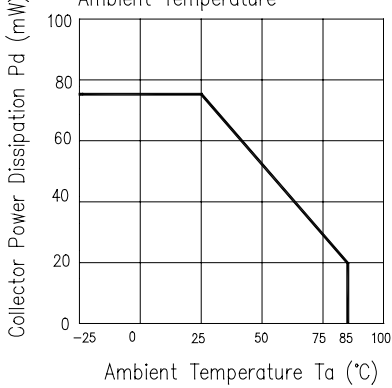

Fig.2 Collector Dark Current vs. Ambient Temperature

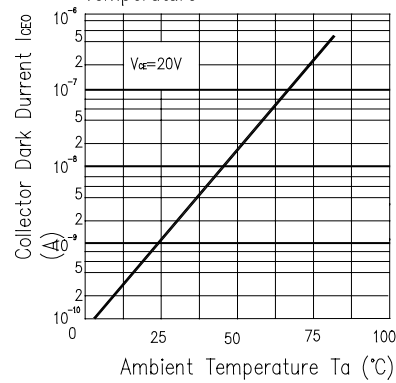

Fig.3 Relative Collector Current vs. Ambient Temperature

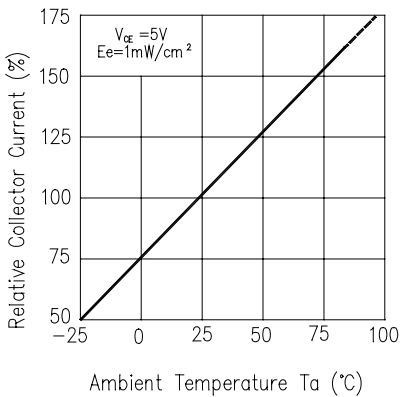

Fig.4 Collector Current vs. Irradiance

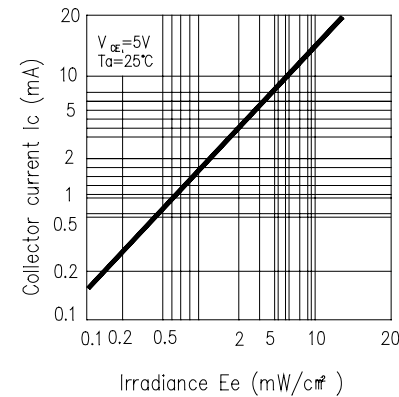

Fig.5 Spectral Sensitivity

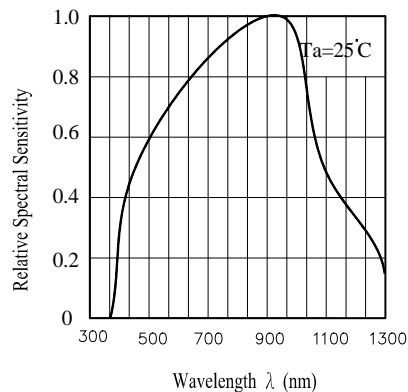
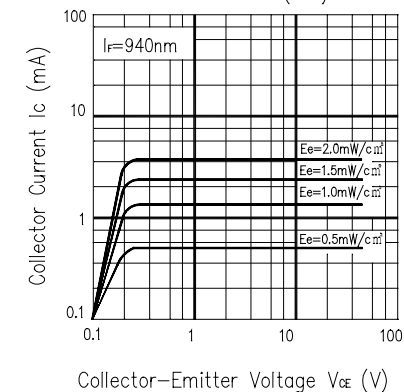

Fig.6 Collector Current vs. Collector Current Ic (mA)





Reliability Test Item And Condition

The reliability of products shall be satisfied with items listed below.

Confidence level : 90%

LTPD : 10%

NO.	Item	Test Conditions	Test Hours/ Cycles	Sample Sizes	Failure Judgement Criteria	Ac/Re
1	Solder Heat	TEMP:260°C±5°C	10sec	22pcs	More than 90% of lead to be covered by soldering $I_R \geq U \times 2$ $E_e \leq L \times 0.8$ $V_F \geq U \times 1.2$ U : Upper Specification Limit L : Lower Specification Limit	0/1
2	Temperature Cycle	H : +100°C 15mins \updownarrow 5mins L : -40°C 15mins	300Cycle	22pcs		0/1
3	Thermal Shock	H : +100°C 5mins \updownarrow 10secs L : -10°C 5mins	300Cycle	22pcs		0/1
4	High Temperature Storage	TEMP. : +100°C	1000hrs	22pcs		0/1
5	Low Temperature Storage	TEMP. : -40°C	1000hrs	22pcs		0/1
6	DC Operating Life	$V_{CE}=5V$	1000hrs	22pcs		0/1
7	High Temperature/ High Humidity	85°C / 85% R.H	1000hrs	22pcs		0/1



Packing Quantity Specification

- 1. 1000 Pcs/1Bag , 10 Bags/1Box
- 2. 10 Boxes/1Carton

Label Form Specification



CPN:

P/N:



QTY: PT908-7C-F



LOT NO:



CAT:

HUE:

REF:

PN: Customer's Production Number

P/N : Production Number

QTY: Packing Quantity

CAT: Ranks

HUE: Peak Wavelength

REF: Reference

LOT No: Lot Number

Notes

- 1. Above specification may be changed without notice. EVERLIGHT will reserve authority on material change for above specification.
- 2. When using this product, please observe the absolute maximum ratings and the instructions for using outlined in these specification sheets. EVERLIGHT assumes no responsibility for any damage resulting from use of the product which does not comply with the absolute maximum ratings and the instructions included in these specification sheets.
- 3. These specification sheets include materials protected under copyright of EVERLIGHT corporation. Please don't reproduce or cause anyone to reproduce them without EVERLIGHT's consent.

EVERLIGHT ELECTRONICS CO., LTD.
Office: No 25, Lane 76, Sec 3, Chung Yang Rd,
Tucheng, Taipei 236, Taiwan, R.O.C

Tel: 886-2-2267-2000, 2267-9936
Fax: 886-2267-6244, 2267-6189, 2267-6306
<http://www.everlight.com>