



RF360
Europe GmbH

SAW components

SAW RF filter
Short range devices

Series/type:	B3728
Ordering code:	B39921B3728U410
Date:	September 15, 2017
Version:	2.4

RF360 products mentioned within this document are products of RF360 Europe GmbH and other subsidiaries of RF360 Holdings Singapore Pte. Ltd. (collectively, the "RF360 Subsidiaries").

RF360 Europe GmbH, Anzinger Str. 13, München, Germany

© 2019 RF360 Europe GmbH and/or its affiliated companies. All rights reserved.

These materials, including the information contained herein, may be used only for informational purposes by the customer. The RF360 Subsidiaries assume no responsibility for errors or omissions in these materials or the information contained herein. The RF360 Subsidiaries reserve the right to make changes to the product(s) or information contained herein without notice. The materials and information are provided on an AS IS basis, and the RF360 Subsidiaries assume no liability and make no warranty or representation, either expressed or implied, with respect to the materials, or any output or results based on the use, application, or evaluation of such materials, including, without limitation, with respect to the non-infringement of trademarks, patents, copyrights or any other intellectual property rights or other rights of third parties.

No use of this documentation or any information contained herein grants any license, whether express, implied, by estoppel or otherwise, to any intellectual property rights, including, without limitation, to any patents owned by QUALCOMM Incorporated or any of its subsidiaries.

Not to be used, copied, reproduced, or modified in whole or in part, nor its contents revealed in any manner to others without the express written permission of RF360 Europe GmbH.

Qualcomm is a trademark of Qualcomm Incorporated, registered in the United States and other countries. Other product and brand names may be trademarks or registered trademarks of their respective owners.

This technical data may be subject to U.S. and international export, re-export, or transfer ("export") laws. Diversion contrary to U.S. and international law is strictly prohibited.

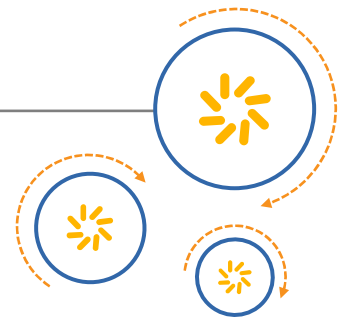

RF360 Europe GmbH
A Qualcomm – TDK Joint Venture

SAW components

SAW RF filter
Short range devices

Series/type:	B3728
Ordering code:	B39921B3728U410
Date:	September 15, 2017
Version:	2.4

RF360 products mentioned within this document are offered by RF360 Europe GmbH and other subsidiaries of RF360 Holdings Singapore Pte. Ltd. (collectively, the “RF360 Subsidiaries”).

RF360 Holdings Singapore Pte. Ltd. is a joint venture of Qualcomm Global Trading Pte. Ltd. and EPCOS AG.

RF360 Europe GmbH, Anzinger Str. 13, München, Germany

© 2017 RF360 Europe GmbH and/or its affiliated companies. All rights reserved.

These materials, including the information contained herein, may be used only for informational purposes by the customer. The RF360 Subsidiaries assume no responsibility for errors or omissions in these materials or the information contained herein. The RF360 Subsidiaries reserve the right to make changes to the product(s) or information contained herein without notice. The materials and information are provided on an AS IS basis, and the RF360 Subsidiaries assume no liability and make no warranty or representation, either expressed or implied, with respect to the materials, or any output or results based on the use, application, or evaluation of such materials, including, without limitation, with respect to the non-infringement of trademarks, patents, copyrights or any other intellectual property rights or other rights of third parties.

No use of this documentation or any information contained herein grants any license, whether express, implied, by estoppel or otherwise, to any intellectual property rights, including, without limitation, to any patents owned by QUALCOMM Incorporated or any of its subsidiaries.

Not to be used, copied, reproduced, or modified in whole or in part, nor its contents revealed in any manner to others without the express written permission of RF360 Europe GmbH.

Qualcomm and Qualcomm RF360 are trademarks of Qualcomm Incorporated, registered in the United States and other countries. RF360 is a trademark of Qualcomm Incorporated. Other product and brand names may be trademarks or registered trademarks of their respective owners.

This technical data may be subject to U.S. and international export, re-export, or transfer ("export") laws. Diversion contrary to U.S. and international law is strictly prohibited.

SAW components	B3728
SAW RF filter	915.0 MHz

Data sheet

Table of contents

1 Application	4
2 Features	4
3 Package	5
4 Pin configuration	5
5 Matching circuit	6
6 Characteristics	7
7 Maximum ratings	10
8 Transmission coefficient	11
9 Reflection coefficients	12
10 Packing material	13
11 Marking	15
12 Soldering profile	16
13 ESD protection of SAW filters	17
14 Annotations	18
15 Cautions and warnings	19
Important notes	20

Data sheet

1 Application

- Low-loss RF filter for remote control receivers
- No external matching components required at 50 Ω

2 Features

- Package size 3.0±0.1 mm × 3.0±0.1 mm
- Package height 1.1±0.125 mm
- Package code DCC6C
- Approximate weight 0.04 g
- RoHS compatible
- Package for Surface Mount Technology (SMT)
- Ni/Au-plated terminals
- Lead free soldering compatible with J-STD20C
- Filter surface passivated
- Electrostatic Sensitive Device (ESD)
- Moisture Sensitivity Level 1 (MSL1)
- AEC-Q200 qualified component family (Grade 1: -40 °C to +125 °C)

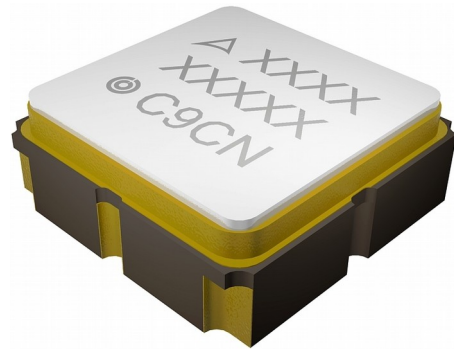
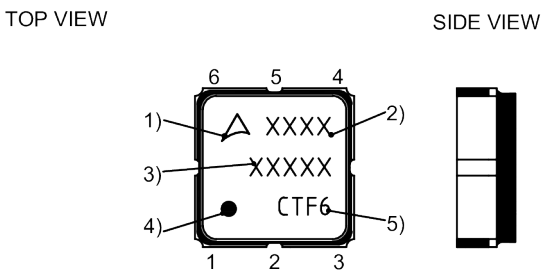
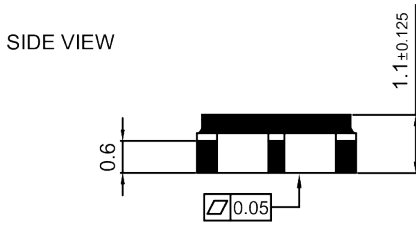
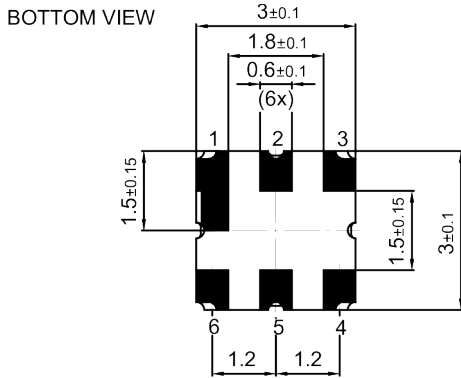

Figure 1: Picture of component with example of product marking.

SAW components **B3728**
SAW RF filter **915.0 MHz**

Data sheet

3 Package



- 1) Company logo
- 2) Device designation
- 3) Last five digits of the lot number
- 4) Marking for pad number 1
- 5) Example of production location and date code

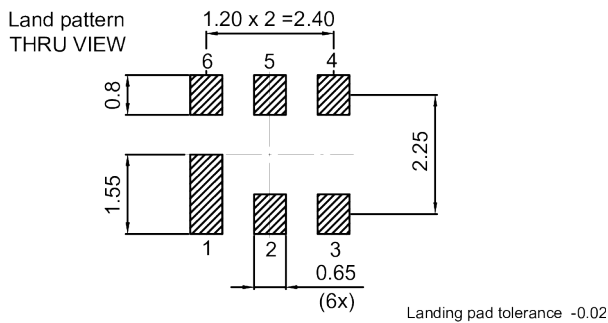

Figure 2: Drawing of package. See Sec. Package information (p. 19).

4 Pin configuration

- 2 Input
- 5 Output
- 1, 3, 4, 6 Ground

Data sheet

5 Matching circuit

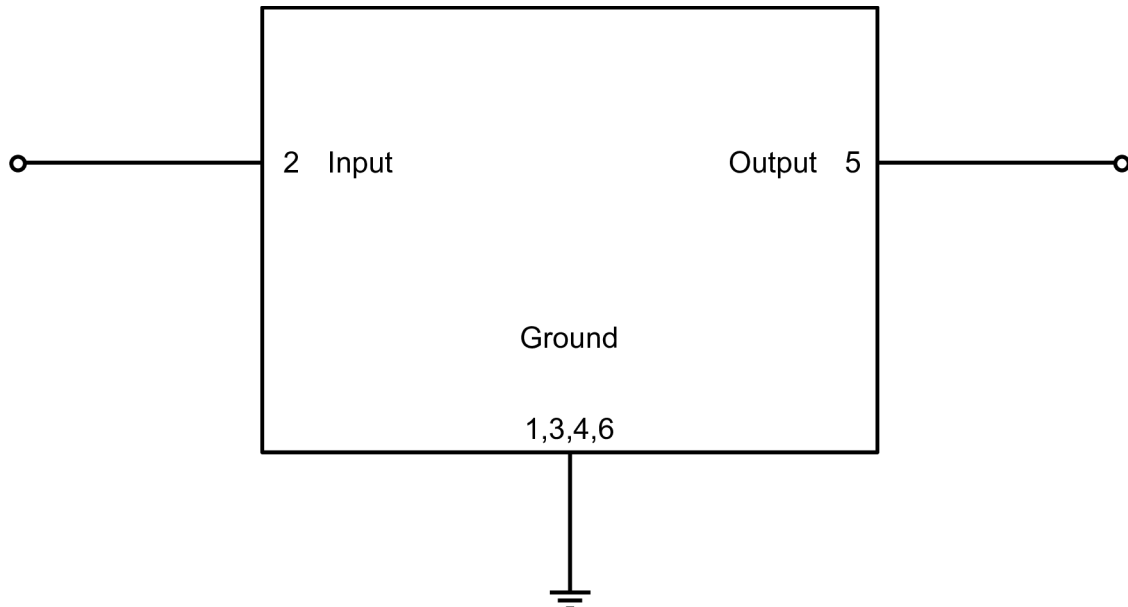

Figure 3: Schematic of matching circuit. No external matching components required.

SAW components

B3728

SAW RF filter

915.0 MHz

Data sheet

6 Characteristics

Temperature range for specification	T_{SPEC}	= -40 °C ... +85 °C
Input terminating impedance	Z_{IN}	= 50 Ω
Output terminating impedance	Z_{OUT}	= 50 Ω

Characteristics			min. for T_{SPEC}	typ. @ +25 °C	max. for T_{SPEC}		
Center frequency		f_C	—	915	—	MHz	
Maximum insertion attenuation	902... 928	MHz	α_{max}	—	2.2	4.0	dB
Amplitude ripple (p-p)	902... 928	MHz	$\Delta\alpha$	—	1.4	3.2	dB
Maximum VSWR			$VSWR_{max}$				
@ input port	902... 928	MHz		—	1.7	2.0	
@ output port	902... 928	MHz		—	1.8	2.0	
Minimum attenuation			α_{min}				
	10... 800	MHz		35	38	—	dB
	800... 888	MHz		36	41	—	dB
	888... 890	MHz		26	40	—	dB
	890... 894	MHz		5	22	—	dB
	940... 941	MHz		27	53	—	dB
	941... 967	MHz		35	52	—	dB
	967... 1350	MHz		38	42	—	dB
	1350... 1600	MHz		35	37	—	dB
	1600... 2000	MHz		30	33	—	dB
	2000... 2500	MHz		28	31	—	dB

SAW components

B3728

SAW RF filter

915.0 MHz

Data sheet

Temperature range for specification	T_{SPEC}	= -25 °C ... +75 °C
Input terminating impedance	Z_{IN}	= 50 Ω
Output terminating impedance	Z_{OUT}	= 50 Ω

Characteristics			min. for T_{SPEC}	typ. @ +25 °C	max. for T_{SPEC}	
Center frequency		f_C	—	915	—	MHz
Maximum insertion attenuation		α_{max}	—	2.2	3.6	dB
	902... 928	MHz				
Amplitude ripple (p-p)		$\Delta\alpha$	—	1.4	2.8	dB
	902... 928	MHz				
Maximum VSWR		VSWR _{max}				
@ input port	902... 928	MHz	—	1.7	2.0	
@ output port	902... 928	MHz	—	1.8	2.0	
Minimum attenuation		α_{min}				
	10... 800	MHz	35	38	—	dB
	800... 888	MHz	37	41	—	dB
	888... 890	MHz	26	40	—	dB
	890... 894	MHz	6	22	—	dB
	940... 941	MHz	31	53	—	dB
	941... 967	MHz	40	52	—	dB
	967... 1350	MHz	38	42	—	dB
	1350... 1600	MHz	35	37	—	dB
	1600... 2000	MHz	30	33	—	dB
	2000... 2500	MHz	28	31	—	dB

SAW components

B3728

SAW RF filter

915.0 MHz

Data sheet

Temperature	T_{SPEC}	= +25 °C
Input terminating impedance	Z_{IN}	= 50 Ω
Output terminating impedance	Z_{OUT}	= 50 Ω

Characteristics			min. for T_{SPEC}	typ. @ +25 °C	max. for T_{SPEC}	
Center frequency			—	915	—	MHz
Maximum insertion attenuation			α_{max}			
	902... 928	MHz	—	2.2	2.6	dB
Amplitude ripple (p-p)			$\Delta\alpha$			
	902... 928	MHz	—	1.4	1.8	dB
Maximum VSWR			VSWR _{max}			
@ input port	902... 928	MHz	—	1.7	2.0	
@ output port	902... 928	MHz	—	1.8	2.0	
Minimum attenuation			α_{min}			
	10... 800	MHz	35	38	—	dB
	800... 888	MHz	39	41	—	dB
	888... 890	MHz	35	40	—	dB
	890... 894	MHz	15	22	—	dB
	940... 941	MHz	45	53	—	dB
	941... 967	MHz	50	52	—	dB
	967... 1350	MHz	40	42	—	dB
	1350... 1600	MHz	35	37	—	dB
	1600... 2000	MHz	30	33	—	dB
	2000... 2500	MHz	28	31	—	dB

SAW components

B3728

SAW RF filter

915.0 MHz

Data sheet

7 Maximum ratings

Operable temperature	$T_{OP} = -45\text{ °C} \dots +125\text{ °C}$	
Storage temperature	$T_{STG}^{1)} = -45\text{ °C} \dots +125\text{ °C}$	
DC voltage	$ V_{DC} = 6.0\text{ V}$	
Source power	P_s	
	15 dBm	Source impedance 50 Ω .
902 ... 928 MHz	18 dBm	Duty cycle 1:10, -40 °C to +85 °C.

¹⁾ Not valid for packaging material. Storage temperature for packaging material is -25 °C to +40 °C.

SAW components	B3728
SAW RF filter	915.0 MHz

Data sheet

8 Transmission coefficient

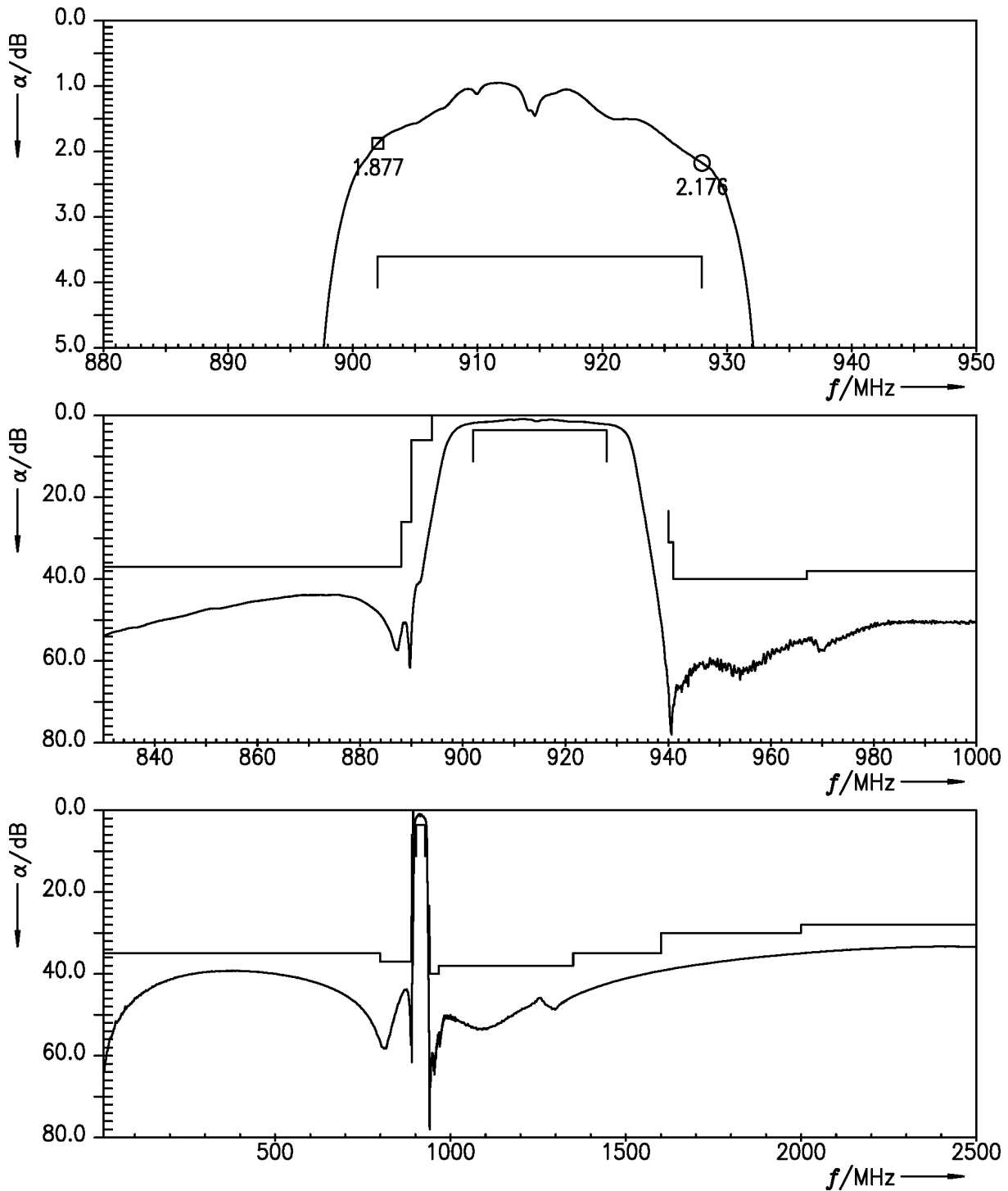

Figure 4: Attenuation.

SAW components	B3728
SAW RF filter	915.0 MHz

Data sheet

9 Reflection coefficients

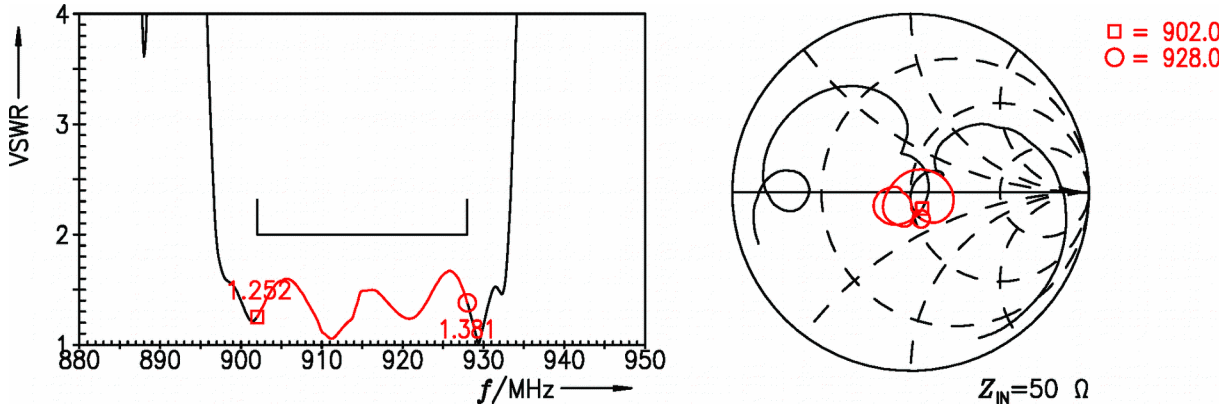

Figure 5: Reflection coefficient at IN port.

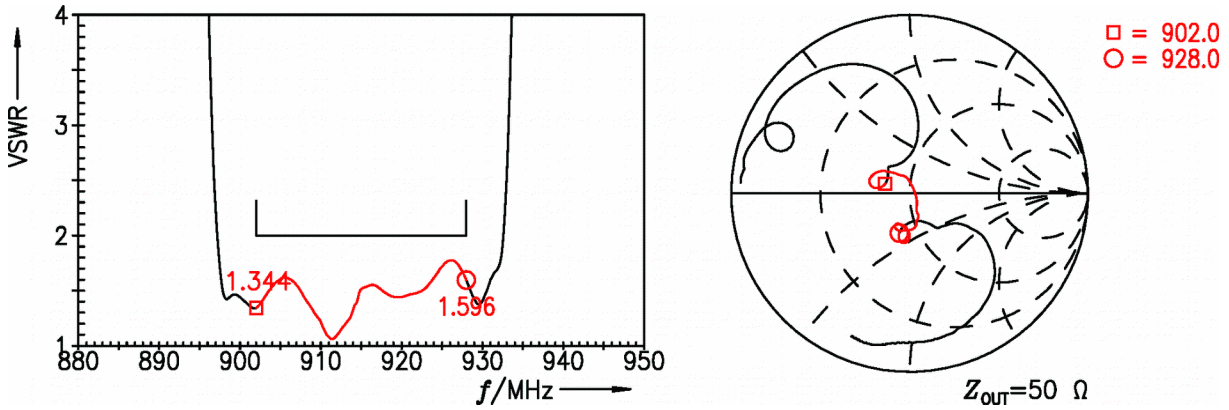

Figure 6: Reflection coefficient at OUT port.

SAW components **B3728**
SAW RF filter **915.0 MHz**

Data sheet

10 Packing material

10.1 Tape

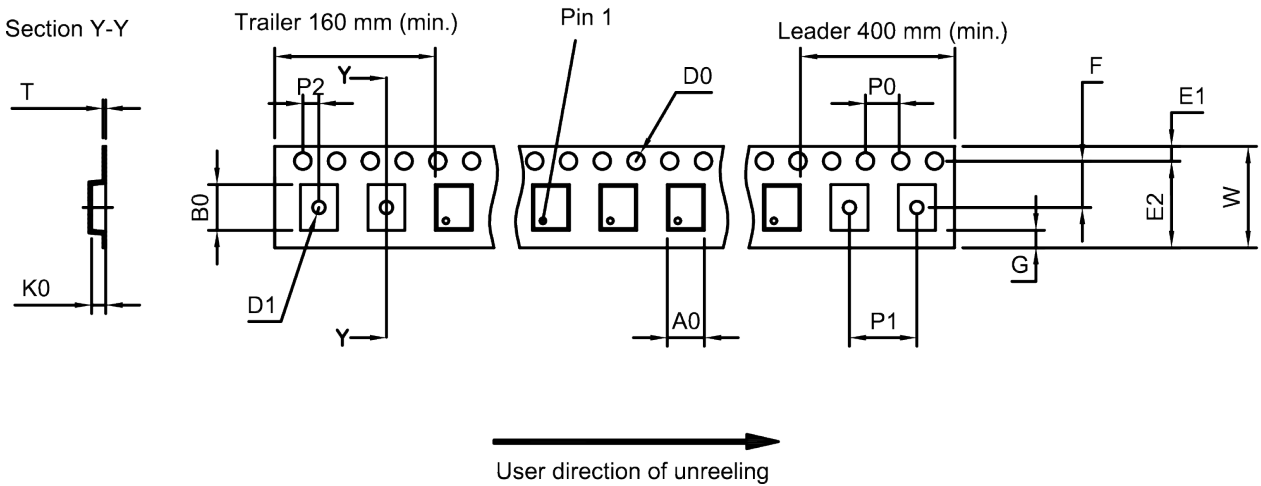

Figure 7: Drawing of tape (first-angle projection) with tape dimensions according to Table 1.

A ₀	3.25±0.1 mm	E ₂	10.25 mm (min.)	P ₁	4.0±0.1 mm
B ₀	3.3±0.1 mm	F	5.5±0.05 mm	P ₂	2.0±0.1 mm
D ₀	1.5+0.1/-0 mm	G	0.75 mm (min.)	T	0.2±0.05 mm
D ₁	1.5 mm (min.)	K ₀	1.5±0.1 mm	W	12.0+0.3/-0.1 mm
E ₁	1.75±0.1 mm	P ₀	4.0±0.1 mm		

Table 1: Tape dimensions.

SAW components	B3728
SAW RF filter	915.0 MHz

Data sheet

10.2 Reel with diameter of 330 mm

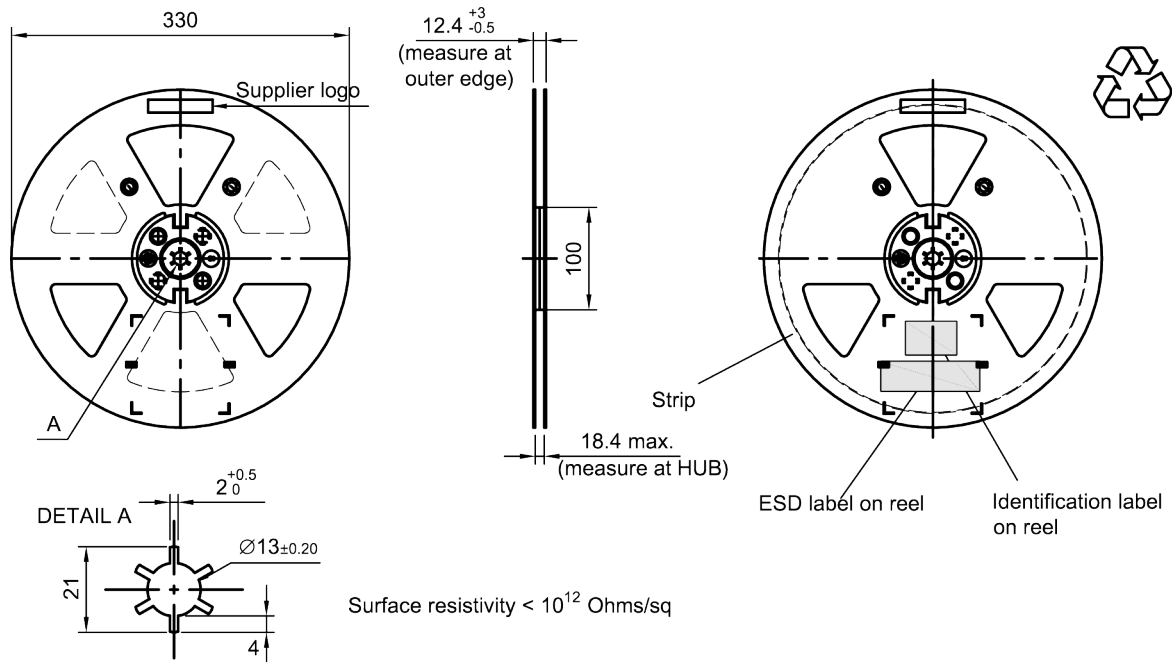
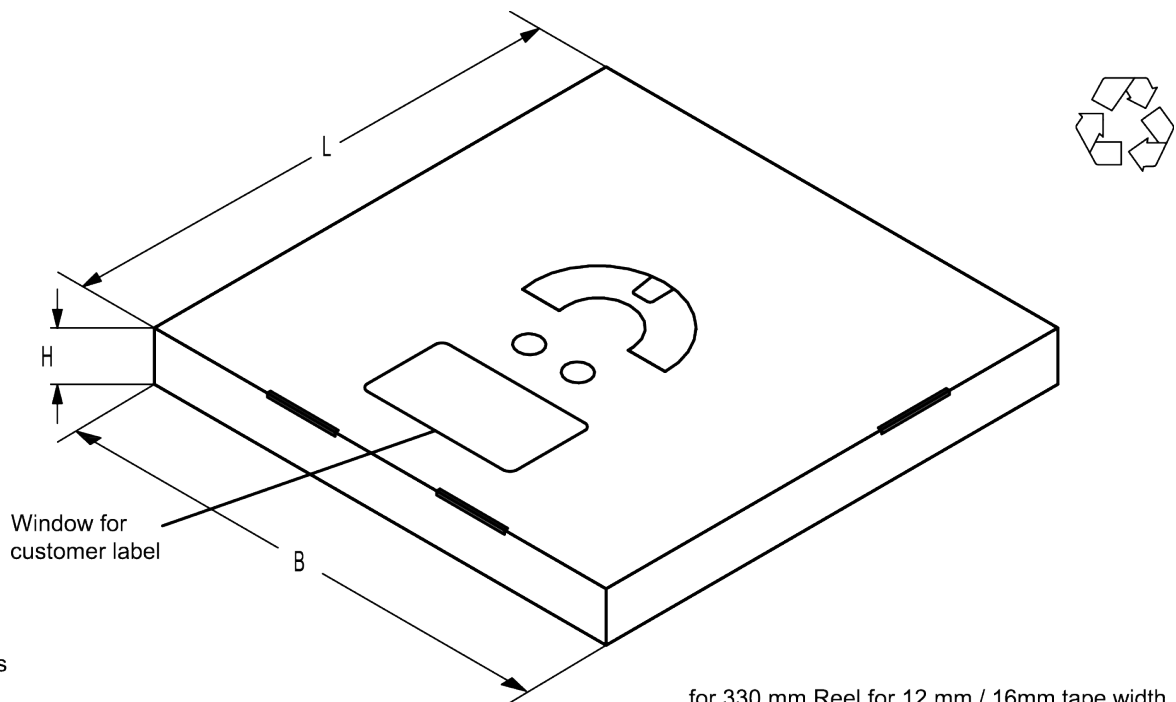

Figure 8: Drawing of reel (first-angle projection) with diameter of 330 mm.



Dimensions

- L = 340
- B = 340
- H = 25

for 330 mm Reel for 12 mm / 16mm tape width SMD packages

Figure 9: Drawing of folding box for reel with diameter of 330 mm.

SAW components

B3728

SAW RF filter

915.0 MHz

Data sheet

11 Marking

Products are marked with device designation, lot number, as well as production location and date code.

- Device designation: The 4-character device designation of the ordering code is used for the marking.

Example for 4-character device designation: B3xxxxB**1234**xxxx

- Lot number: The last 5 digits of the lot number are used for the marking.

Example: **12345**

- Production location and date code: The production location is Wuxi (encoded in the first character 'C'). The production date code is encoded in the last three characters according to Table 2.

1 st digit (day)						2 nd digit (year)				3 rd digit (month)			
Day	Code	Day	Code	Day	Code	Year	Code	Year	Code	Month	Code	Month	Code
1	1	11	A	21	M	2010	A	2022	P	Jan	1	Jul	7
2	2	12	B	22	N	2011	B	2023	R	Feb	2	Aug	8
3	3	13	C	23	P	2012	C	2024	S	Mar	3	Sep	9
4	4	14	D	24	R	2013	D	2025	T	Apr	4	Oct	0
5	5	15	E	25	S	2014	E	2026	U	May	5	Nov	N
6	6	16	F	26	T	2015	F	2027	V	Jun	6	Dec	D
7	7	17	H	27	U	2016	H	2028	W				
8	8	18	J	28	V	2017	J	2029	X				
9	9	19	K	29	W	2018	K	2030	Z				
10	0	20	L	30	X	2019	L	2031	A				
				31	Z	2020	M	2032	B				
						2021	N	and so on					

Table 2: Production date code.

Example of how to decode production location and date code:

Code: **C T F 6**

Location: **C** → Wuxi

Day: **T** → 26th

Year: **F** → 2015

Month: **6** → June

Data sheet

12 Soldering profile

The recommended soldering process is in accordance with IEC 60068-2-58 – 3rd edit and IPC/JEDEC J-STD-020B.

ramp rate	≤ 3 K/s
preheat	125 °C to 220 °C, 150 s to 210 s, 0.4 K/s to 1.0 K/s
$T > 220$ °C	30 s to 70 s
$T > 230$ °C	min. 10 s
$T > 245$ °C	max. 20 s
$T \geq 255$ °C	–
peak temperature T_{peak}	250 °C $\pm 0/-5$ °C
wetting temperature T_{min}	230 °C $\pm 5/0$ °C for 10 s ± 1 s
cooling rate	≤ 3 K/s
soldering temperature T	measured at solder pads

Table 3: Characteristics of recommended soldering profile for lead-free solder (Sn95.5Ag3.8Cu0.7).

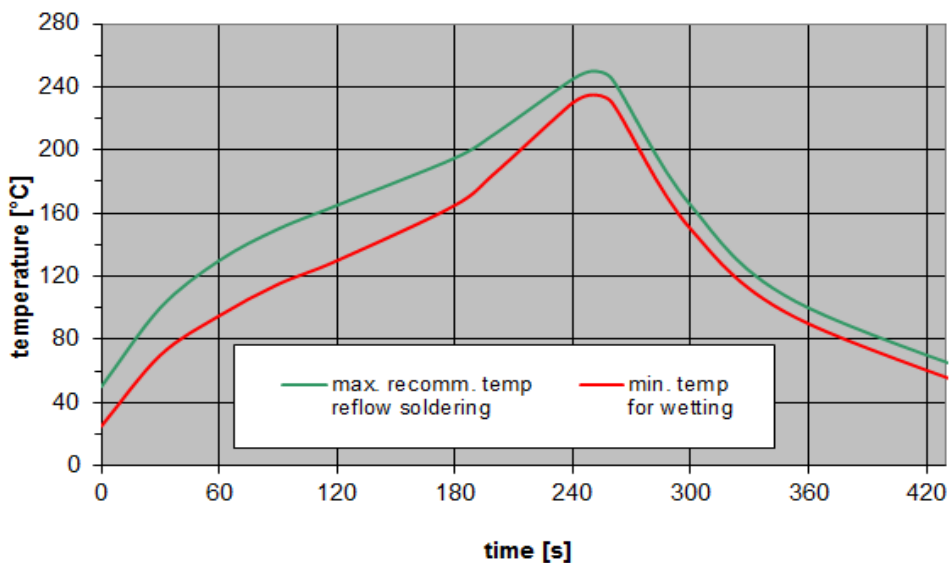

Figure 10: Recommended reflow profile for convection and infrared soldering – lead-free solder.

Data sheet

13 ESD protection of SAW filters

SAW filters are **E**lectro **S**tatic **D**ischarge sensitive devices. To reduce the probability of damages caused by ESD, special matching topologies have to be applied.

In general, “ESD matching” has to be ensured at that filter port, where electrostatic discharge is expected.

Electrostatic discharges predominantly appear at the antenna input of RF receivers. Therefore, only the input matching of the SAW filter has to be designed to short circuit or to block the ESD pulse.

Below three figures show recommended “ESD matching” topologies.

For wide band filters the high-pass ESD matching structure needs to be at least of 3rd order to ensure a proper matching for any impedance value of antenna and SAW filter input. The required component values have to be determined from case to case.

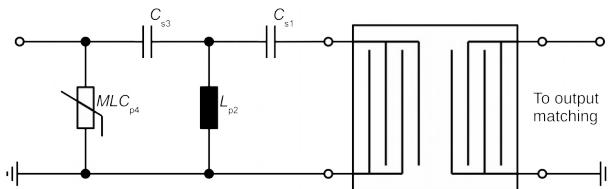

Figure 11: MLC varistor plus ESD matching.

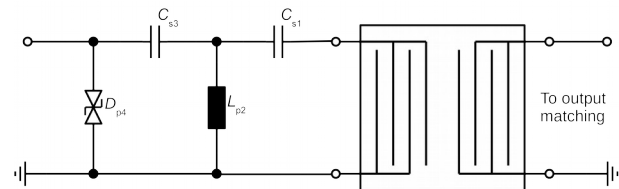

Figure 12: Suppressor diode plus ESD matching.

In cases where minor ESD occur, following simplified “ESD matching” topologies can be used alternatively.

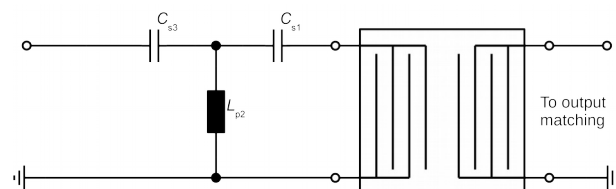

Figure 13: 3rd order high-pass structure for basic ESD protection.

In all three figures the shunt inductor L_{p2} could be replaced by a shorted microstrip with proper length and width. If this configuration is possible depends on the operating frequency and available PCB space.

Effectiveness of the applied ESD protection has to be checked according to relevant industry standards or customer specific requirements.

For further information, please refer to RF360 Application report: “**ESD protection for SAW filters**”. This report can be found under www.rf360jv.com/rke. Click on “Applications Notes”.

SAW components	B3728
SAW RF filter	915.0 MHz

Data sheet

14 Annotations

14.1 Matching coils

See TDK inductor pdf-catalog <http://www.tdk.co.jp/tefe02/coil.htm#aname1> and Data Library for circuit simulation <http://www.tdk.co.jp/etvcl/index.htm>.

14.2 RoHS compatibility

ROHS-compatible means that products are compatible with the requirements according to Art. 4 (substance restrictions) of Directive 2011/65/EU of the European Parliament and of the Council of June 8th, 2011, on the restriction of the use of certain hazardous substances in electrical and electronic equipment ("Directive") with due regard to the application of exemptions as per Annex III of the Directive in certain cases.

14.3 Scattering parameters (S-parameters)

The pin/port assignment is available in the headers of the S-parameter files. Please contact your local RF360 sales office.

Data sheet

15 Cautions and warnings

15.1 Display of ordering codes for RF360 products

The ordering code for one and the same product can be represented differently in data sheets, data books, other publications and the website of RF360, or in order-related documents such as shipping notes, order confirmations and product labels. The varying representations of the ordering codes are due to different processes employed and do not affect the specifications of the respective products. Detailed information can be found on the Internet under www.rf360jv.com/orderingcodes.

15.2 Material information

Due to technical requirements components may contain dangerous substances. For information on the type in question please also contact one of our sales offices.

For information on recycling of tapes and reels please contact one of our sales offices.

15.3 Moldability

Before using in overmolding environment, please contact your local RF360 sales office.

15.4 Package information

Landing area

The printed circuit board (PCB) land pattern (landing area) shown is based on RF360 internal development and empirical data and illustrated for example purposes, only. As customers' SMD assembly processes may have a plenty of variants and influence factors which are not under control or knowledge of RF360, additional careful process development on customer side is necessary and strongly recommended in order to achieve best soldering results tailored to the particular customer needs.

Dimensions

Unless otherwise specified all dimensions are understood using unit millimeter (mm).

Projection method

Unless otherwise specified first-angle projection is applied.

Important notes

The following applies to all products named in this publication:

1. Some parts of this publication contain **statements about the suitability of our products for certain areas of application**. These statements are based on our knowledge of typical requirements that are often placed on our products in the areas of application concerned. We nevertheless expressly point out **that such statements cannot be regarded as binding statements about the suitability of our products for a particular customer application**. As a rule, RF360 Europe GmbH and its affiliates are either unfamiliar with individual customer applications or less familiar with them than the customers themselves. For these reasons, it is always ultimately incumbent on the customer to check and decide whether an RF360 product with the properties described in the product specification is suitable for use in a particular customer application.
2. We also point out that **in individual cases, a malfunction of electronic components or failure before the end of their usual service life cannot be completely ruled out in the current state of the art, even if they are operated as specified**. In customer applications requiring a very high level of operational safety and especially in customer applications in which the malfunction or failure of an electronic component could endanger human life or health (e.g. in accident prevention or life-saving systems), it must therefore be ensured by means of suitable design of the customer application or other action taken by the customer (e.g. installation of protective circuitry or redundancy) that no injury or damage is sustained by third parties in the event of malfunction or failure of an electronic component.
3. **The warnings, cautions and product-specific notes must be observed.**
4. In order to satisfy certain technical requirements, **some of the products described in this publication may contain substances subject to restrictions in certain jurisdictions (e.g. because they are classed as hazardous)**. Useful information on this will be found in our Material Data Sheets on the Internet (www.rf360jv.com/material). Should you have any more detailed questions, please contact our sales offices.
5. We constantly strive to improve our products. Consequently, **the products described in this publication may change from time to time**. The same is true of the corresponding product specifications. Please check therefore to what extent product descriptions and specifications contained in this publication are still applicable before or when you place an order. We also **reserve the right to discontinue production and delivery of products**. Consequently, we cannot guarantee that all products named in this publication will always be available.
The aforementioned does not apply in the case of individual agreements deviating from the foregoing for customer-specific products.