

#### Features

- 1.High current transfer ratio.
- 2.Opaque type, mini-flat package.
- 3.Subminiature type (The volume is smaller than that of our conventional DIP type by as far as 30%).
- 4.Isolation voltage between input and output Viso:3750Vrms.
- 5.Emloys double transfer mold technology.
- 6.Recognized by UL and CUL, file NO.E225308.
- 7.Approved by VDE 0884 Teil2(NO:40017614).
- 8.Moisture Sensitivity Level : Level 4.
- 9..Package : 1000Pcs / Reel.
- 10.RoHS Compliant.

#### Applications

- 1.Hybrid substrates that require high density mounting.
- 2.Programmable controllers.

#### \*PACKAGE DIMENSIONS (UNIT:mm) SMD Type

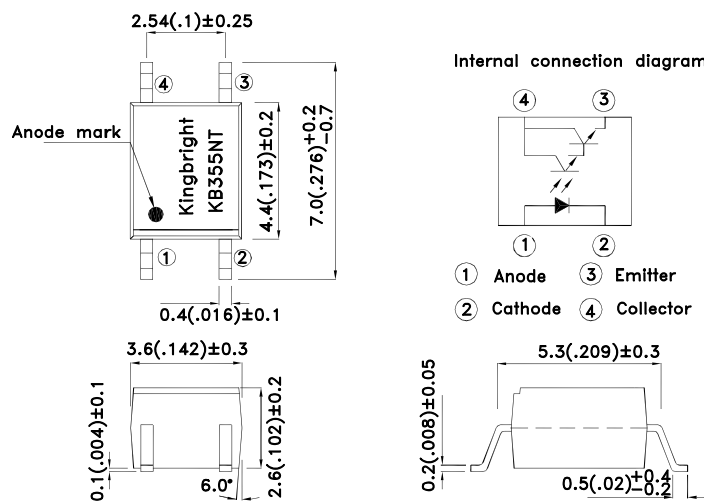

UNIT : MM[INCH]  
TOLERANCE : ±0.5[±0.02] UNLESS OTHERWISE NOTED.



**\*Absolute Maximum Ratings (TA=25°C)**

	Parameter	Symbol	Rating	Unit
Input	Forward current	IF	50	mA
	Reverse voltage	VR	6	V
	Power dissipation	P	70	mW
Output	Collector-emitter voltage	VCEO	35	V
	Emitter-collector voltage	VECO	6	V
	Collector current	IC	80	mA
	Collector power dissipation	Pc	150	mW
Total power dissipation		Ptot	170	mW
* <sup>1</sup> Isolation voltage		Viso	3750	Vrms
Operating temperature		Topr	-30 to +100	°C
Storage temperature		Tstg	-40 to +125	°C
* <sup>2</sup> Soldering temperature		Tsol	260	°C

<sup>1</sup> 40 to 60% RH, AC for 1 minute.

<sup>2</sup> For 10 seconds.

**\*Electro-optical Characteristics**

	Parameter	Symbol	Conditions	Min.	Typ.	Max.	Unit	
Input	Forward voltage	VF	IF=20mA	-	1.2	1.4	V	
	Peak forward voltage	VFM	IFM=0.5A	-	-	3.0	V	
	Reverse current	IR	VR=4V	-	-	10	uA	
Output	Collector dark current	ICEO	VCE=10V, IF=0	-	-	10 <sup>-6</sup>	A	
	Collector-emitter breakdown voltage	BVCEO	IC=0.1mA, IF=0	35	-	-	V	
	Emitter-collector breakdown voltage	BVECO	IE=10uA, IF=0	6	-	-	V	
Transfer Characteristics	Current transfer ratio	CTR	IF=1mA, VCE=2V	600	1600	7500	%	
	Collector-emitter saturation voltage	VCE(sat)	IF=20mA, IC=1mA	-	0.8	1.0	V	
	Response time	Rise time	Tr	VCE=2V, IC=2mA RL=100Ω	-	60	300	uS
		Fall time	Tf		-	53	250	uS

**Fig. 1 Current Transfer vs. Forward Current**

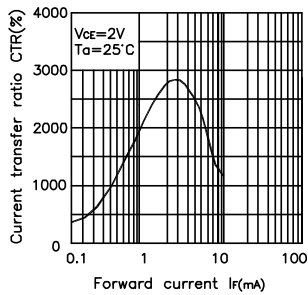

**Fig. 2 Forward Current vs. Forward Voltage**

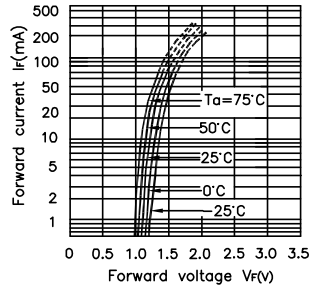

**Fig. 3 Collector Current vs. Collector-emitter Voltage**

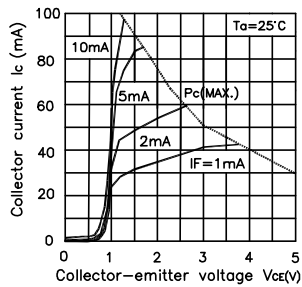

**Fig. 4 Forward Current vs. Ambient Temperature**

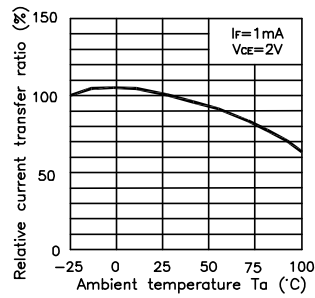

**Fig. 5 Collector-emitter Saturation Voltage vs. Ambient Temperature**

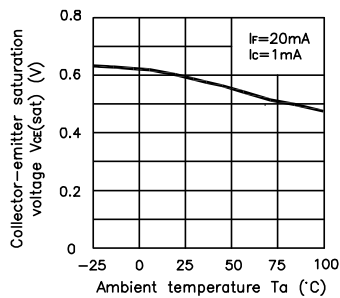

**Fig. 6 Response Time vs. Load Resistance**

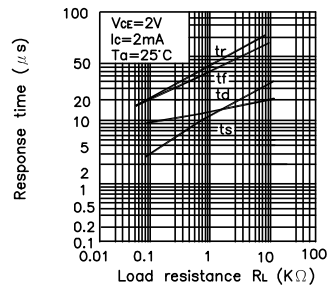

**Fig. 7 Collector-emitter Saturation Voltage vs. Forward Current**

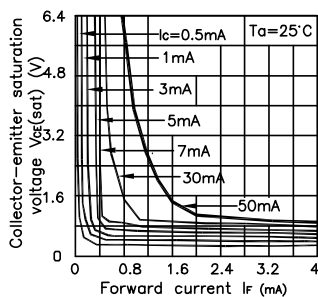

**Fig. 8 Collector Dark Current vs. Ambient Temperature**

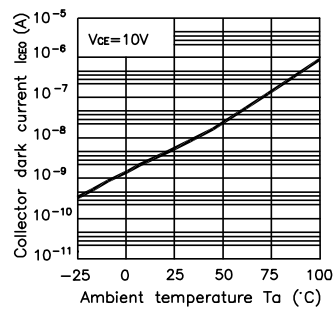

#### Test Circuit for Response Time

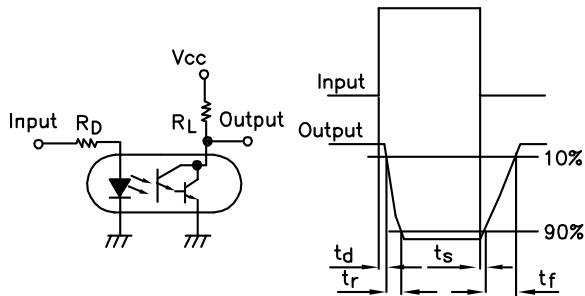

#### \*NOTES ON HANDLING

##### 1. Cautions regarding noise

Be aware that power is suddenly into the componment any surge current may cause damage happen, even if the voltage is within the absolute maximum ratings.

Reflow Soldering Profile For Lead-free SMT Process.

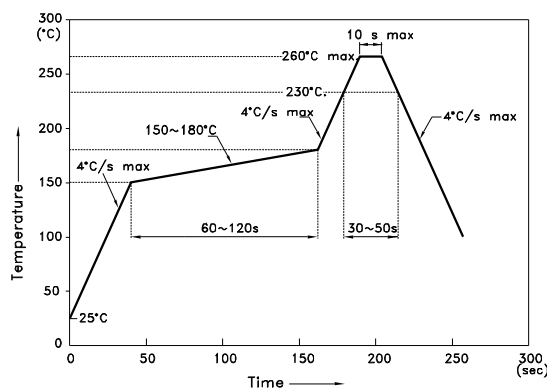

**NOTES:**

1. We recommend the reflow temperature 245°C(+/-5°C). The maximum soldering temperature should be limited to 260°C.
2. Don't cause stress to the epoxy resin while it is exposed to high temperature.
3. Number of reflow process shall be 2 times or less.

#### CAUTION

Within this device there exists GaAs (Gallium Arsenide) material which is a harmful substance if ingested. GaAs dust and fumes are toxic. Do not break, cut or pulverize the product, or use chemicals to dissolve them.

#### RESTRICTIONS ON PRODUCT USE

- The information in this document is subject to change without notice. Before using this document, please confirm that this is the latest version. Not all devices / types available in every country.
- We are mention about our product quality stability, semiconductor devices in general can malfunction or fail due to their inherent electrical sensitivity and vulnerability to physical stress. It is the responsibility of the buyer, when utilizing KINGBRIGHT products, to observe standards of safety, and to a avoid situations in which a malfunction or failure of a KINGBRIGHT product could cause loss of human life, bodily injury or damage to property. In developing your designs, please ensure that KINGBRIGHT products are used within specified operating ranges as set forth in the most recent products specifications.

#### Outline and Dimension (Tape) (Units : mm)

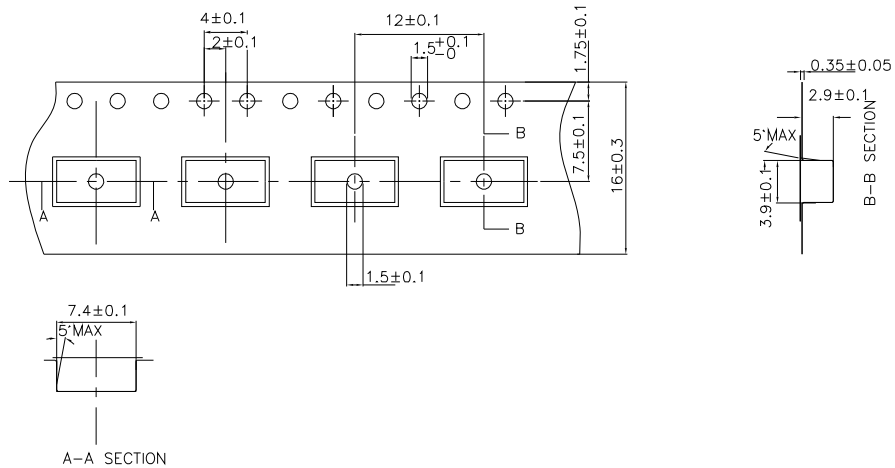

#### Tape Direction

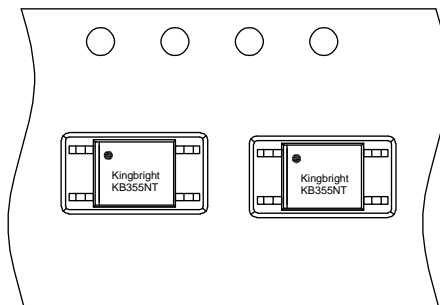

#### Outline and Dimension (Reel)

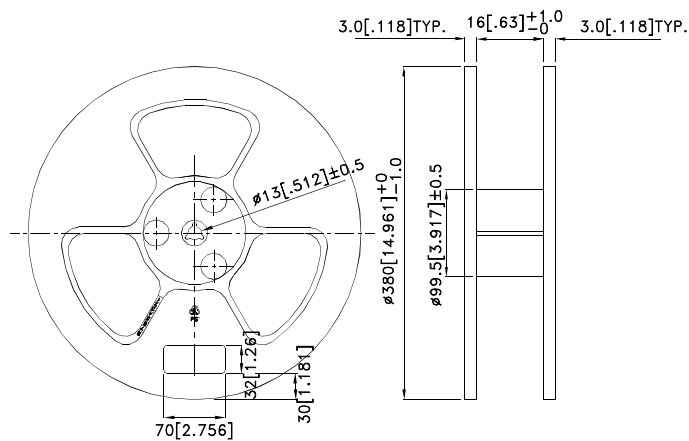

Packing: 1000pcs/reel

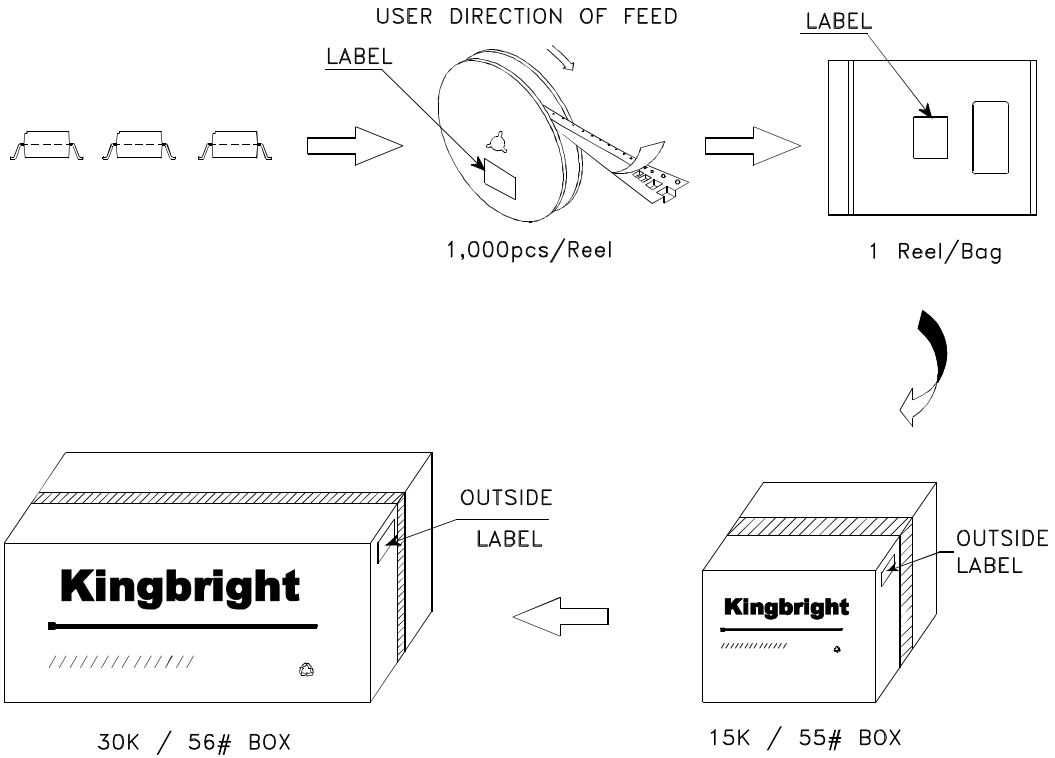

<h1>Kingbright</h1>		
P/NO: KB355xxx		
QTY: 1000 pcs	Q.C.	Q C XX XX XXXX PASSED
S/N: XXXX		
CODE: XXX		
LOT NO:		
 xxxxxxxxxxxxxxxxxxxxxxxxxxxx		
RoHS Compliant		