

Data sheet

Commercial Art.No.: 25.394.3653.0

PCB pin header 8113 S / 6 S OB

PCB pin header, connection method depends on used socket part , 6 poles, pitch: 5 mm, type of packing: carton, color: grey

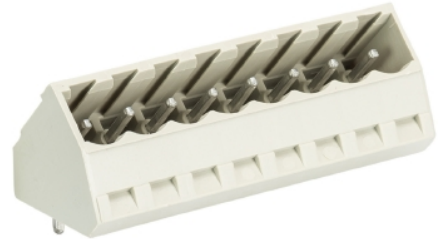

Commercial Art.No.	25.394.3653.0
EAN	4015573329409
Order Unit	50

Certificates / Approvals



Technical data

General

Modular spacing	5 mm
Soldering process	Wave soldering
Packaging	Carton
Number of poles	6
Number of levels	1
Marking	No
Fastening	None
Mating direction towards (circuit) board	45°

Technical data

Rated current	12 A
Overvoltage Category I	1000 V
Overvoltage Category II	400 V
Overvoltage Category III	250 V
Rated impulse voltage	4 kV

Technical Data UL/CSA

Voltage UL	300 V
Current field wiring	15 A
Current factory wiring	15 A
Voltage CSA	300 V
Current CSA	15 A

Other

Type of insulation material	Thermoplastic
Color	Grey
Height	14.6 mm

Length	31.2 mm
Depth	16 mm
Material contact base	CuZn
Material contact surface	Sn

Classification

ECLASS 11	
ECLASS 8.1	27440402
ETIM 7.0	EC002637
ETIM 6.0	EC002637
ETIM 5.0	EC002637
ETIM 4.0	EC002637

Product compliance

ROHS conformity status	Compliant
REACH-SVHC conformity status	Compliant

Fits with

Commercial Art.No.:	Article-type description:	Description:
25.220.3653.0	PCB connector 8113 B / 6 TOP OB	PCB female connector with front/top screw connection, 6 poles, max. cross section: 2.5 mm ² , pitch: 5 mm, type of packing: carton, color: grey
25.220.0653.0	PCB connector 8113 B / 6 TOP	PCB female connector with front/top screw connection, 6 poles, printed version, max. cross section: 2.5 mm ² , pitch: 5 mm, type of packing: carton, color: grey
01.060.3653.0	PCB connector 8113 BK / 6 OB	PCB female connector with Crimp connection, 6 poles, max. cross section: 2.5 mm ² , pitch: 5 mm, type of packing: carton, color: grey
01.060.0653.0	PCB connector 8113 BK / 6	PCB female connector with Crimp connection, 6 poles, printed version, max. cross section: 2.5 mm ² , pitch: 5 mm, type of packing: carton, color: grey
25.320.3653.0	PCB connector 8113 B / 6 OB	PCB female connector with screw connection with rising cage clamp system, 6 poles, max. cross section: 2.5 mm ² , pitch: 5 mm, type of packing: carton, color: grey
25.320.0653.0	PCB connector 8113 B / 6	PCB female connector with screw connection with rising cage clamp system, 6 poles, printed version, max. cross section: 2.5 mm ² , pitch: 5 mm, type of packing: carton, color: grey
25.325.3653.0	PCB connector 8113 B / 6 VR OB	PCB female connector with screw connection with rising cage clamp system, 6 poles, max. cross section: 2.5 mm ² , pitch: 5 mm, type of packing: carton, color: grey
25.325.0653.0	PCB connector 8113 B / 6 VR	PCB female connector with screw connection with rising cage clamp system, 6 poles, printed version, max. cross section: 2.5 mm ² , pitch: 5 mm, type of packing: carton, color: grey
25.326.3653.0	PCB connector 8113 B / 6 VL OB	PCB female connector with screw connection with rising cage clamp system, 6 poles, max. cross section: 2.5 mm ² , pitch: 5 mm, type of packing: carton, color: grey
25.326.0653.0	PCB connector 8113 B / 6 VL	PCB female connector with screw connection with rising cage clamp system, 6 poles, printed version, max. cross section: 2.5 mm ² , pitch: 5 mm, type of packing: carton, color: grey
25.820.3653.0	PCB connector 8113 BFK / 6 TOP OB	PCB female connector with tension spring connection, 6 poles, max. cross section: 2.5 mm ² , pitch: 5 mm, type of packing: carton, color: grey

25.820.0653.0	PCB connector 8113 BFK / 6 TOP	PCB female connector with tension spring connection, 6 poles, printed version, max. cross section: 2.5 mm ² , pitch: 5 mm, type of packing: carton, color: grey
---------------	--------------------------------	--

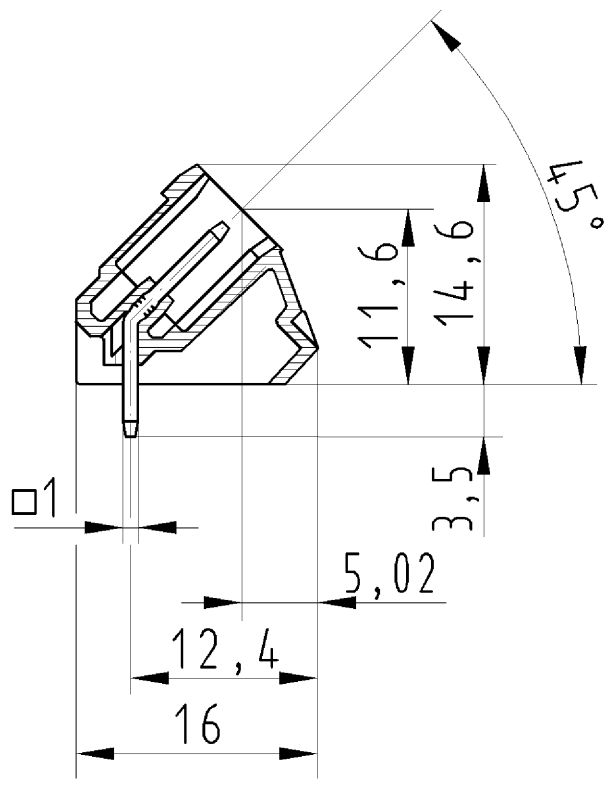
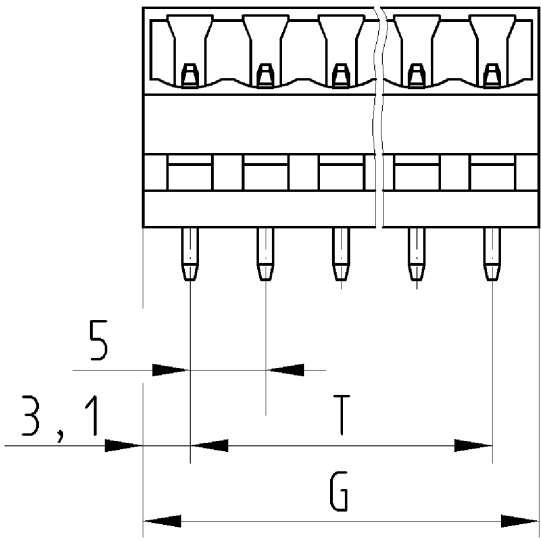

für folgende Tabellen-Zchnng.:
25.394.3253.0 8113 S/...S

LP.STIFTLLEISTE
25.394.3253.0 10W
12.11.2007 SCJ
M 2:1