

LOW-POWER TRIPLE BUFFER/DRIVER WITH OPEN-DRAIN OUTPUTS

 Check for Samples: [SN74AUP3G07](#)

FEATURES

- Available in the Texas Instruments NanoStar™ Package
- Low Static-Power Consumption ($I_{CC} = 0.9 \mu\text{A}$ Maximum)
- Low Dynamic-Power Consumption ($C_{pd} = 4.3 \text{ pF}$ Typ at 3.3 V)
- Low Input Capacitance ($C_i = 1.5 \text{ pF}$ Typical)
- Low Noise – Overshoot and Undershoot <math><10\%</math> of V_{CC}
- I_{off} Supports Partial-Power-Down Mode Operation
- Wide Operating V_{CC} Range of 0.8 V to 3.6 V
- Optimized for 3.3-V Operation
- 3.6-V I/O Tolerant to Support Mixed-Mode Signal Operation
- $t_{pd} = 4.3 \text{ ns}$ Maximum at 3.3 V
- Suitable for Point-to-Point Applications
- Latch-Up Performance Exceeds 100 mA Per JESD 78, Class II
- ESD Performance Tested Per JESD 22
 - 2000-V Human-Body Model (A114-B, Class II)
 - 1000-V Charged-Device Model (C101)

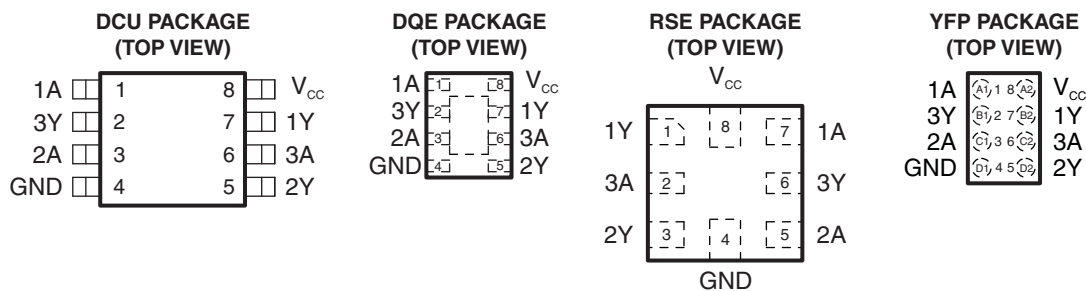

See mechanical drawings for dimensions.

DESCRIPTION/ORDERING INFORMATION

The AUP family is TI's premier solution to the industry's low-power needs in battery-powered portable applications. This family ensures a very low static- and dynamic-power consumption across the entire V_{CC} range of 0.8 V to 3.6 V, resulting in increased battery life (see [Figure 1](#)). This product also maintains excellent signal integrity (see the very low undershoot and overshoot characteristics shown in [Figure 2](#)).

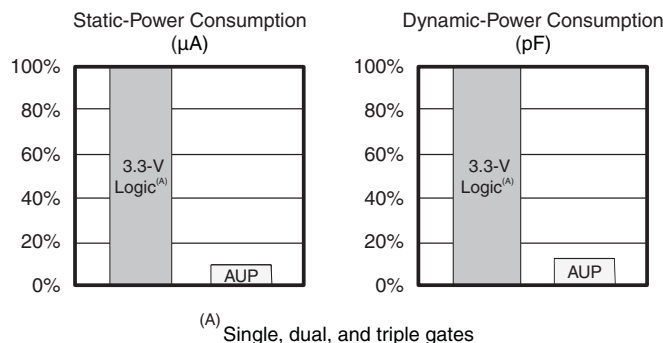
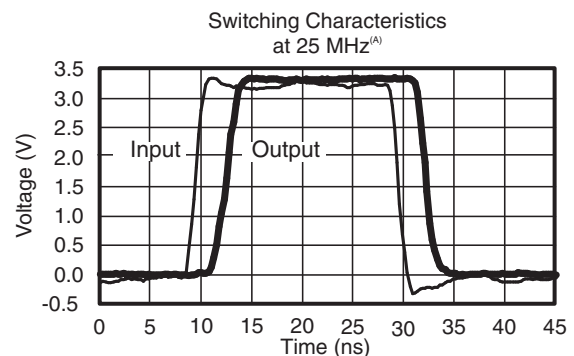

Figure 1. AUP – The Lowest-Power Family

 (A) SN74AUP3Gxx data at $C_L = 15 \text{ pF}$.

Figure 2. Excellent Signal Integrity

Please be aware that an important notice concerning availability, standard warranty, and use in critical applications of Texas Instruments semiconductor products and disclaimers thereto appears at the end of this data sheet.

NanoStar is a trademark of Texas Instruments.

The output of SN74AUP3G07 is open drain and can be connected to other open-drain outputs to implement active-low wired-OR or active-high wired-AND functions.

NanoStar™ package technology is a major breakthrough in IC packaging concepts, using the die as the package.

This device is fully specified for partial-power-down applications using I_{off}. The I_{off} circuitry disables the outputs, preventing damaging current backflow through the device when it is powered down.

ORDERING INFORMATION⁽¹⁾

T _A	PACKAGE ⁽²⁾		ORDERABLE PART NUMBER	TOP-SIDE MARKING ⁽³⁾
-40°C to 85°C	NanoStar™ – WCSP (DSBGA) 0.23-mm Large Bump – YFP (Pb-free)	Reel of 3000	SN74AUP3G07YFPR	_ _ H V _
	X2SON – DQE	Reel of 5000	SN74AUP3G07DQER	TW
	UQFN – RSE	Reel of 5000	SN74AUP3G07RSER	TW
	US8 – DCU	Reel of 3000	SN74AUP3G07DCUR	H07_

- (1) For the most current package and ordering information, see the Package Option Addendum at the end of this document, or see the TI web site at www.ti.com.
- (2) Package drawings, thermal data, and symbolization are available at www.ti.com/packaging.
- (3) DCU: The actual top-side marking has one additional character that designates the wafer fab/assembly site.
YFP: The actual top-side marking has three preceding characters to denote year, month, and sequence code, and one following character to designate the wafer fab/assembly site. Pin 1 identifier indicates solder-bump composition (1 = SnPb, • = Pb-free).

**FUNCTION TABLE
(EACH BUFFER/DRIVER)**

INPUT A	OUTPUT Y
L	L
H	Z

LOGIC DIAGRAM (POSITIVE LOGIC)

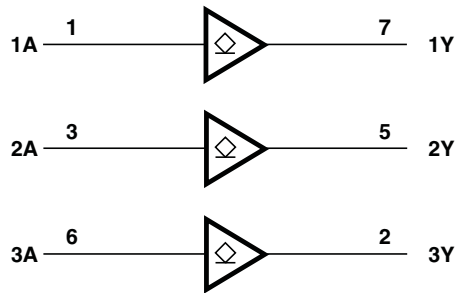

Pin numbers shown are for the DCU and DQE packages.

ABSOLUTE MAXIMUM RATINGS⁽¹⁾

over operating free-air temperature range (unless otherwise noted)

			MIN	MAX	UNIT
V_{CC}	Supply voltage range		-0.5	4.6	V
V_I	Input voltage range ⁽²⁾		-0.5	4.6	V
V_O	Voltage range applied to any output in the high-impedance or power-off state ⁽²⁾		-0.5	4.6	V
V_O	Output voltage range in the high or low state ⁽²⁾		-0.5	$V_{CC} + 0.5$	V
I_{IK}	Input clamp current	$V_I < 0$		-50	mA
I_{OK}	Output clamp current	$V_O < 0$		-50	mA
I_O	Continuous output current			±20	mA
	Continuous current through V_{CC} or GND			±50	mA
θ_{JA}	Package thermal impedance ⁽³⁾	DCU package		220	°C/W
		DQE package		261	
		RSE package		253	
		YFP package		132	
T_{stg}	Storage temperature range		-65	150	°C

- (1) Stresses beyond those listed under "absolute maximum ratings" may cause permanent damage to the device. These are stress ratings only, and functional operation of the device at these or any other conditions beyond those indicated under "recommended operating conditions" is not implied. Exposure to absolute-maximum-rated conditions for extended periods may affect device reliability.
- (2) The input negative-voltage and output voltage ratings may be exceeded if the input and output current ratings are observed.
- (3) The package thermal impedance is calculated in accordance with JEDEC 51-7.

RECOMMENDED OPERATING CONDITIONS⁽¹⁾

		MIN	MAX	UNIT	
V _{CC}	Supply voltage	0.8	3.6	V	
V _{IH}	High-level input voltage	V _{CC} = 0.8 V	V _{CC}	V	
		V _{CC} = 1.1 V to 1.95 V	0.65 × V _{CC}		
		V _{CC} = 2.3 V to 2.7 V	1.6		
		V _{CC} = 3 V to 3.6 V	2		
V _{IL}	Low-level input voltage	V _{CC} = 0.8 V	0	V	
		V _{CC} = 1.1 V to 1.95 V	0.35 × V _{CC}		
		V _{CC} = 2.3 V to 2.7 V	0.7		
		V _{CC} = 3 V to 3.6 V	0.9		
V _I	Input voltage	0	3.6	V	
V _O	Output voltage	0	3.6	V	
I _{OL}	Low-level output current	V _{CC} = 0.8 V	20	μA	
		V _{CC} = 1.1 V	1.1	mA	
		V _{CC} = 1.4 V	1.7		
		V _{CC} = 1.65 V	1.9		
		V _{CC} = 2.3 V	3.1		
		V _{CC} = 3 V	4		
Δt/Δv	Input transition rise or fall rate	V _{CC} = 0.8 V to 3.6 V	200	ns/V	
T _A	Operating free-air temperature		–40	85	°C

(1) All unused inputs of the device must be held at V_{CC} or GND to ensure proper device operation. See the TI application report *Implications of Slow or Floating CMOS Inputs*, literature number [SCBA004](#).

ELECTRICAL CHARACTERISTICS

over recommended operating free-air temperature range (unless otherwise noted)

PARAMETER	TEST CONDITIONS	V _{CC}	T _A = 25°C			T _A = -40°C to 85°C		UNIT
			MIN	TYP	MAX	MIN	MAX	
V _{OL}	I _{OL} = 20 μA	0.8 V to 3.6 V			0.1		0.1	V
	I _{OL} = 1.1 mA	1.1 V			0.3 × V _{CC}		0.3 × V _{CC}	
	I _{OL} = 1.7 mA	1.4 V			0.31		0.37	
	I _{OL} = 1.9 mA	1.65 V			0.31		0.35	
	I _{OL} = 2.3 mA	2.3 V			0.31		0.33	
	I _{OL} = 3.1 mA				0.44		0.45	
	I _{OL} = 2.7 mA	3 V			0.31		0.33	
	I _{OL} = 4 mA				0.44		0.45	
I _I	A or B input	V _I = GND to 3.6 V			0.1		0.5	μA
I _{off}		V _I or V _O = 0 V to 3.6 V			0.2		0.6	μA
ΔI _{off}		V _I or V _O = 0 V to 3.6 V			0.2		0.6	μA
I _{CC}		V _I = GND or (V _{CC} to 3.6 V), I _O = 0			0.5		0.9	μA
ΔI _{CC}		V _I = V _{CC} - 0.6 V ⁽¹⁾ , I _O = 0			40		50	μA
C _i	V _I = V _{CC} or GND	0 V		1.5				pF
		3.6 V		1.5				
C _o	V _O = GND	0 V		3				pF

 (1) One input at V_{CC} - 0.6 V, other input at V_{CC} or GND

SWITCHING CHARACTERISTICSover recommended operating free-air temperature range, $C_L = 5$ pF (unless otherwise noted) (see [Figure 3](#) and [Figure 4](#))

PARAMETER	FROM (INPUT)	TO (OUTPUT)	V_{CC}	$T_A = 25^\circ\text{C}$			$T_A = -40^\circ\text{C}$ to 85°C		UNIT
				MIN	TYP	MAX	MIN	MAX	
t_{pd}	A	Y	0.8 V	12.2					ns
			$1.2\text{ V} \pm 0.1\text{ V}$	3.4	5.1	7.5	1.5	14.7	
			$1.5\text{ V} \pm 0.1\text{ V}$	2.3	3.6	5.1	1.3	8.3	
			$1.8\text{ V} \pm 0.15\text{ V}$	2.4	3.1	4	1	6.3	
			$2.5\text{ V} \pm 0.2\text{ V}$	1.5	2.1	2.9	0.9	4.1	
			$3.3\text{ V} \pm 0.3\text{ V}$	1.8	2.2	2.8	1.1	3.3	

SWITCHING CHARACTERISTICSover recommended operating free-air temperature range, $C_L = 10$ pF (unless otherwise noted) (see [Figure 3](#) and [Figure 4](#))

PARAMETER	FROM (INPUT)	TO (OUTPUT)	V_{CC}	$T_A = 25^\circ\text{C}$			$T_A = -40^\circ\text{C}$ to 85°C		UNIT
				MIN	TYP	MAX	MIN	MAX	
t_{pd}	A	Y	0.8 V	15					ns
			$1.2\text{ V} \pm 0.1\text{ V}$	4	6.2	9	2.4	16.2	
			$1.5\text{ V} \pm 0.1\text{ V}$	3.1	4.4	6.1	2	9.4	
			$1.8\text{ V} \pm 0.15\text{ V}$	3.3	3.9	4.8	1.6	7.1	
			$2.5\text{ V} \pm 0.2\text{ V}$	2.1	2.8	3.5	1.3	4.8	
			$3.3\text{ V} \pm 0.3\text{ V}$	2.3	3	4	1.4	4.5	

SWITCHING CHARACTERISTICSover recommended operating free-air temperature range, $C_L = 15$ pF (unless otherwise noted) (see [Figure 3](#) and [Figure 4](#))

PARAMETER	FROM (INPUT)	TO (OUTPUT)	V_{CC}	$T_A = 25^\circ\text{C}$			$T_A = -40^\circ\text{C}$ to 85°C		UNIT
				MIN	TYP	MAX	MIN	MAX	
t_{pd}	A	Y	0.8 V	18.2					ns
			$1.2\text{ V} \pm 0.1\text{ V}$	4.9	7.3	10.4	3.2	17.6	
			$1.5\text{ V} \pm 0.1\text{ V}$	3.8	5.2	6.8	2.6	10.2	
			$1.8\text{ V} \pm 0.15\text{ V}$	3.4	4.8	6.7	2.2	7.9	
			$2.5\text{ V} \pm 0.2\text{ V}$	2.4	3.4	4.5	1.9	5.3	
			$3.3\text{ V} \pm 0.3\text{ V}$	2.2	3.7	5.4	1.8	6.1	

SWITCHING CHARACTERISTICSover recommended operating free-air temperature range, $C_L = 30$ pF (unless otherwise noted) (see [Figure 3](#) and [Figure 4](#))

PARAMETER	FROM (INPUT)	TO (OUTPUT)	V_{CC}	$T_A = 25^\circ\text{C}$			$T_A = -40^\circ\text{C}$ to 85°C		UNIT
				MIN	TYP	MAX	MIN	MAX	
t_{pd}	A	Y	0.8 V	26.5					ns
			$1.2\text{ V} \pm 0.1\text{ V}$	8.1	10.7	14.4	4.5	21.9	
			$1.5\text{ V} \pm 0.1\text{ V}$	3.0	7.7	12.3	2.5	13	
			$1.8\text{ V} \pm 0.15\text{ V}$	4.8	7.5	9.7	3.6	11	
			$2.5\text{ V} \pm 0.2\text{ V}$	3.7	5.4	6.7	2.8	7.1	
			$3.3\text{ V} \pm 0.3\text{ V}$	3.9	6.3	9.7	2.8	10.4	

OPERATING CHARACTERISTICS
 $T_A = 25^\circ\text{C}$

PARAMETER		TEST CONDITIONS	V_{CC}	TYP	UNIT
C_{pd}	Power dissipation capacitance	$f = 10\text{ MHz}$	0.8 V	4	pF
			$1.2\text{ V} \pm 0.1\text{ V}$	4	
			$1.5\text{ V} \pm 0.1\text{ V}$	4	
			$1.8\text{ V} \pm 0.15\text{ V}$	4	
			$2.5\text{ V} \pm 0.2\text{ V}$	4.1	
			$3.3\text{ V} \pm 0.3\text{ V}$	4.3	

**PARAMETER MEASUREMENT INFORMATION
(Propagation Delays, Setup and Hold Times, and Pulse Width)**

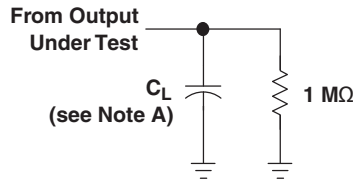

LOAD CIRCUIT

	$V_{CC} = 0.8\text{ V}$	$V_{CC} = 1.2\text{ V}$ $\pm 0.1\text{ V}$	$V_{CC} = 1.5\text{ V}$ $\pm 0.1\text{ V}$	$V_{CC} = 1.8\text{ V}$ $\pm 0.15\text{ V}$	$V_{CC} = 2.5\text{ V}$ $\pm 0.2\text{ V}$	$V_{CC} = 3.3\text{ V}$ $\pm 0.3\text{ V}$
C_L	5, 10, 15, 30 pF	5, 10, 15, 30 pF	5, 10, 15, 30 pF	5, 10, 15, 30 pF	5, 10, 15, 30 pF	5, 10, 15, 30 pF
V_M	$V_{CC}/2$	$V_{CC}/2$	$V_{CC}/2$	$V_{CC}/2$	$V_{CC}/2$	$V_{CC}/2$
V_I	V_{CC}	V_{CC}	V_{CC}	V_{CC}	V_{CC}	V_{CC}

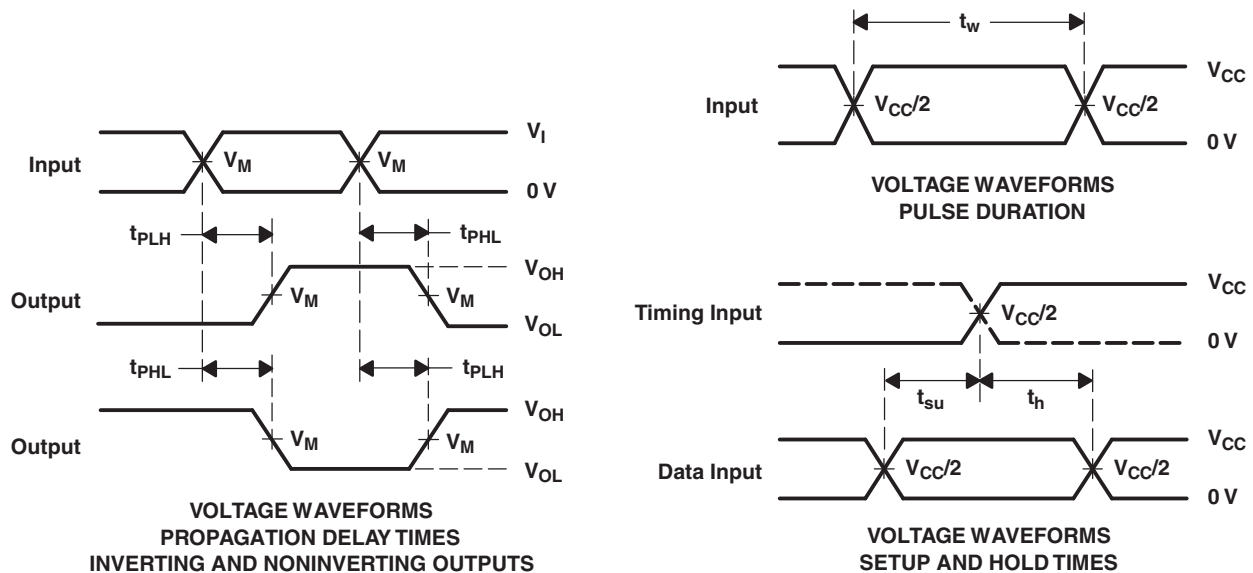

- A. C_L includes probe and jig capacitance.
- B. Waveform 1 is for an output with internal conditions such that the output is low, except when disabled by the output control. Waveform 2 is for an output with internal conditions such that the output is high, except when disabled by the output control.
- C. All input pulses are supplied by generators having the following characteristics: PRR $\leq 10\text{ MHz}$, $Z_O = 50\ \Omega$, for propagation delays $t_r/t_f = 3\text{ ns}$, for setup and hold times and pulse width $t_r/t_f = 1.2\text{ ns}$.
- D. The outputs are measured one at a time, with one transition per measurement.
- E. t_{PLH} and t_{PHL} are the same as t_{pd} .
- F. All parameters and waveforms are not applicable to all devices.

Figure 3. Load Circuit and Voltage Waveforms

**PARAMETER MEASUREMENT INFORMATION
(Enable and Disable Times)**

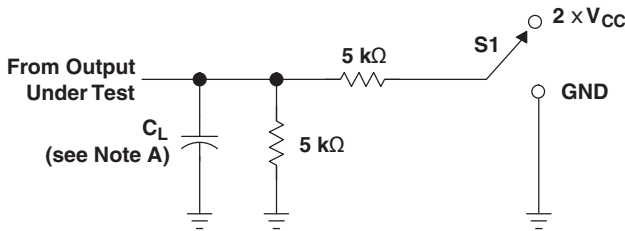

TEST	S1
t_{PLZ}/t_{PZL}	$2 \times V_{CC}$
t_{PHZ}/t_{PZH}	GND

LOAD CIRCUIT

	$V_{CC} = 0.8\text{ V}$	$V_{CC} = 1.2\text{ V} \pm 0.1\text{ V}$	$V_{CC} = 1.5\text{ V} \pm 0.1\text{ V}$	$V_{CC} = 1.8\text{ V} \pm 0.15\text{ V}$	$V_{CC} = 2.5\text{ V} \pm 0.2\text{ V}$	$V_{CC} = 3.3\text{ V} \pm 0.3\text{ V}$
C_L	5, 10, 15, 30 pF	5, 10, 15, 30 pF	5, 10, 15, 30 pF	5, 10, 15, 30 pF	5, 10, 15, 30 pF	5, 10, 15, 30 pF
V_M	$V_{CC}/2$	$V_{CC}/2$	$V_{CC}/2$	$V_{CC}/2$	$V_{CC}/2$	$V_{CC}/2$
V_I	V_{CC}	V_{CC}	V_{CC}	V_{CC}	V_{CC}	V_{CC}
V_{Δ}	0.1 V	0.1 V	0.1 V	0.15 V	0.15 V	0.3 V

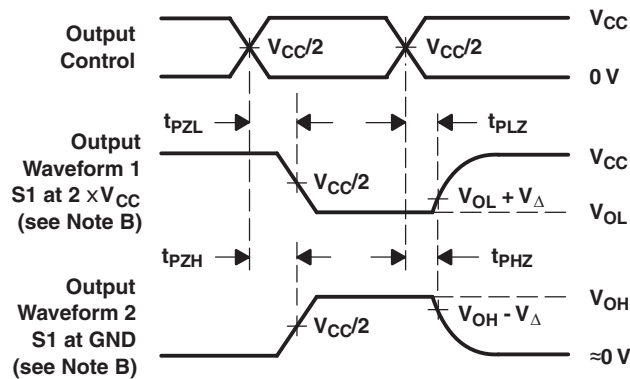

**VOLTAGE WAVEFORMS
ENABLE AND DISABLE TIMES
LOW- AND HIGH-LEVEL ENABLING**

- A. C_L includes probe and jig capacitance.
- B. Waveform 1 is for an output with internal conditions such that the output is low, except when disabled by the output control. Waveform 2 is for an output with internal conditions such that the output is high, except when disabled by the output control.
- C. All input pulses are supplied by generators having the following characteristics: $PRR \leq 10\text{ MHz}$, $Z_O = 50\ \Omega$, $t_r/t_f = 3\text{ ns}$.
- D. The outputs are measured one at a time, with one transition per measurement.
- E. t_{PLZ} and t_{PHZ} are the same as t_{dis} .
- F. t_{PLH} and t_{PHL} are the same as t_{pd} .
- G. All parameters and waveforms are not applicable to all devices.

Figure 4. Load Circuit and Voltage Waveforms

REVISION HISTORY

Changes from Revision B (March 2010) to Revision C	Page
• Updated ORDERING INFORMATION table.	2
• Changed max value for V_O from V_{CC} to 3.6 V	4

PACKAGING INFORMATION

Orderable Device	Status (1)	Package Type	Package Drawing	Pins	Package Qty	Eco Plan (2)	Lead/Ball Finish (6)	MSL Peak Temp (3)	Op Temp (°C)	Device Marking (4/5)	Samples
SN74AUP3G07DCUR	ACTIVE	VSSOP	DCU	8	3000	Green (RoHS & no Sb/Br)	NIPDAU	Level-1-260C-UNLIM	-40 to 85	H07R	Samples
SN74AUP3G07DQER	ACTIVE	X2SON	DQE	8	5000	Green (RoHS & no Sb/Br)	NIPDAUAG	Level-1-260C-UNLIM	-40 to 85	TW	Samples
SN74AUP3G07RSER	ACTIVE	UQFN	RSE	8	5000	Green (RoHS & no Sb/Br)	NIPDAUAG	Level-1-260C-UNLIM	-40 to 85	TW	Samples
SN74AUP3G07YFPR	ACTIVE	DSBGA	YFP	8	3000	Green (RoHS & no Sb/Br)	SNAGCU	Level-1-260C-UNLIM	-40 to 85	HVN	Samples

(1) The marketing status values are defined as follows:

ACTIVE: Product device recommended for new designs.

LIFEBUY: TI has announced that the device will be discontinued, and a lifetime-buy period is in effect.

NRND: Not recommended for new designs. Device is in production to support existing customers, but TI does not recommend using this part in a new design.

PREVIEW: Device has been announced but is not in production. Samples may or may not be available.

OBSELETE: TI has discontinued the production of the device.

(2) **RoHS:** TI defines "RoHS" to mean semiconductor products that are compliant with the current EU RoHS requirements for all 10 RoHS substances, including the requirement that RoHS substance do not exceed 0.1% by weight in homogeneous materials. Where designed to be soldered at high temperatures, "RoHS" products are suitable for use in specified lead-free processes. TI may reference these types of products as "Pb-Free".

RoHS Exempt: TI defines "RoHS Exempt" to mean products that contain lead but are compliant with EU RoHS pursuant to a specific EU RoHS exemption.

Green: TI defines "Green" to mean the content of Chlorine (Cl) and Bromine (Br) based flame retardants meet JS709B low halogen requirements of <=1000ppm threshold. Antimony trioxide based flame retardants must also meet the <=1000ppm threshold requirement.

(3) MSL, Peak Temp. - The Moisture Sensitivity Level rating according to the JEDEC industry standard classifications, and peak solder temperature.

(4) There may be additional marking, which relates to the logo, the lot trace code information, or the environmental category on the device.

(5) Multiple Device Markings will be inside parentheses. Only one Device Marking contained in parentheses and separated by a "-" will appear on a device. If a line is indented then it is a continuation of the previous line and the two combined represent the entire Device Marking for that device.

(6) Lead/Ball Finish - Orderable Devices may have multiple material finish options. Finish options are separated by a vertical ruled line. Lead/Ball Finish values may wrap to two lines if the finish value exceeds the maximum column width.

Important Information and Disclaimer:The information provided on this page represents TI's knowledge and belief as of the date that it is provided. TI bases its knowledge and belief on information provided by third parties, and makes no representation or warranty as to the accuracy of such information. Efforts are underway to better integrate information from third parties. TI has taken and

continues to take reasonable steps to provide representative and accurate information but may not have conducted destructive testing or chemical analysis on incoming materials and chemicals. TI and TI suppliers consider certain information to be proprietary, and thus CAS numbers and other limited information may not be available for release.

In no event shall TI's liability arising out of such information exceed the total purchase price of the TI part(s) at issue in this document sold by TI to Customer on an annual basis.

TAPE AND REEL INFORMATION



QUADRANT ASSIGNMENTS FOR PIN 1 ORIENTATION IN TAPE



*All dimensions are nominal

Device	Package Type	Package Drawing	Pins	SPQ	Reel Diameter (mm)	Reel Width W1 (mm)	A0 (mm)	B0 (mm)	K0 (mm)	P1 (mm)	W (mm)	Pin1 Quadrant
SN74AUP3G07DCUR	VSSOP	DCU	8	3000	180.0	8.4	2.25	3.35	1.05	4.0	8.0	Q3
SN74AUP3G07DQER	X2SON	DQE	8	5000	180.0	8.4	1.2	1.6	0.55	4.0	8.0	Q1
SN74AUP3G07RSER	UQFN	RSE	8	5000	180.0	8.4	1.7	1.7	0.7	4.0	8.0	Q2
SN74AUP3G07YFPR	DSBGA	YFP	8	3000	178.0	9.2	0.9	1.75	0.6	4.0	8.0	Q1

TAPE AND REEL BOX DIMENSIONS

*All dimensions are nominal

Device	Package Type	Package Drawing	Pins	SPQ	Length (mm)	Width (mm)	Height (mm)
SN74AUP3G07DCUR	VSSOP	DCU	8	3000	202.0	201.0	28.0
SN74AUP3G07DQER	X2SON	DQE	8	5000	202.0	201.0	28.0
SN74AUP3G07RSER	UQFN	RSE	8	5000	202.0	201.0	28.0
SN74AUP3G07YFPR	DSBGA	YFP	8	3000	220.0	220.0	35.0

DQE (R-PX2SON-N8)

PLASTIC SMALL OUTLINE NO-LEAD

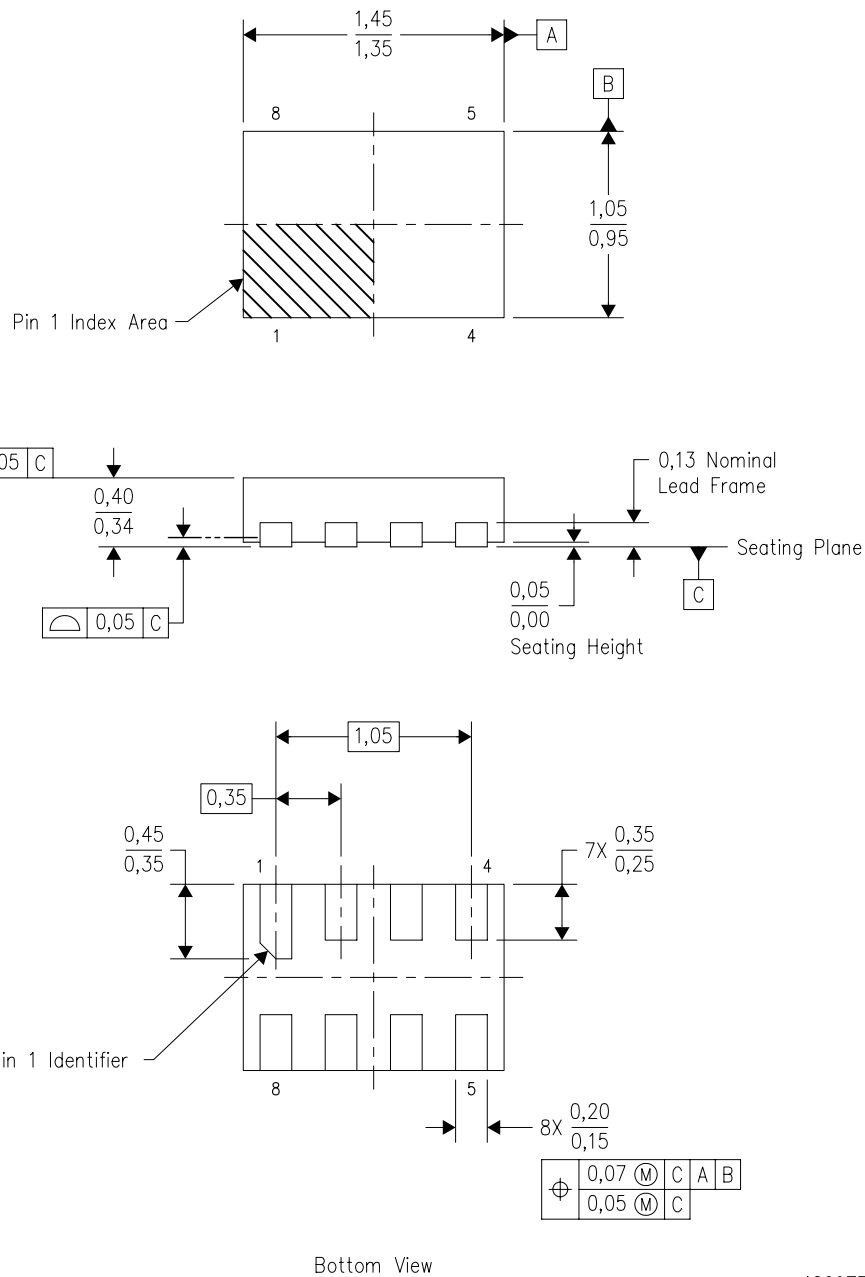

4209779/B 10/2008

- NOTES:
- All linear dimensions are in millimeters. Dimensioning and tolerancing per ASME Y14.5M-1994.
 - This drawing is subject to change without notice.
 - SON (Small Outline No-Lead) package configuration.
 - This package complies to JEDEC MO-287 variation X2EAF.

DQE (R-PX2SON-N8)

PLASTIC SMALL OUTLINE NO-LEAD

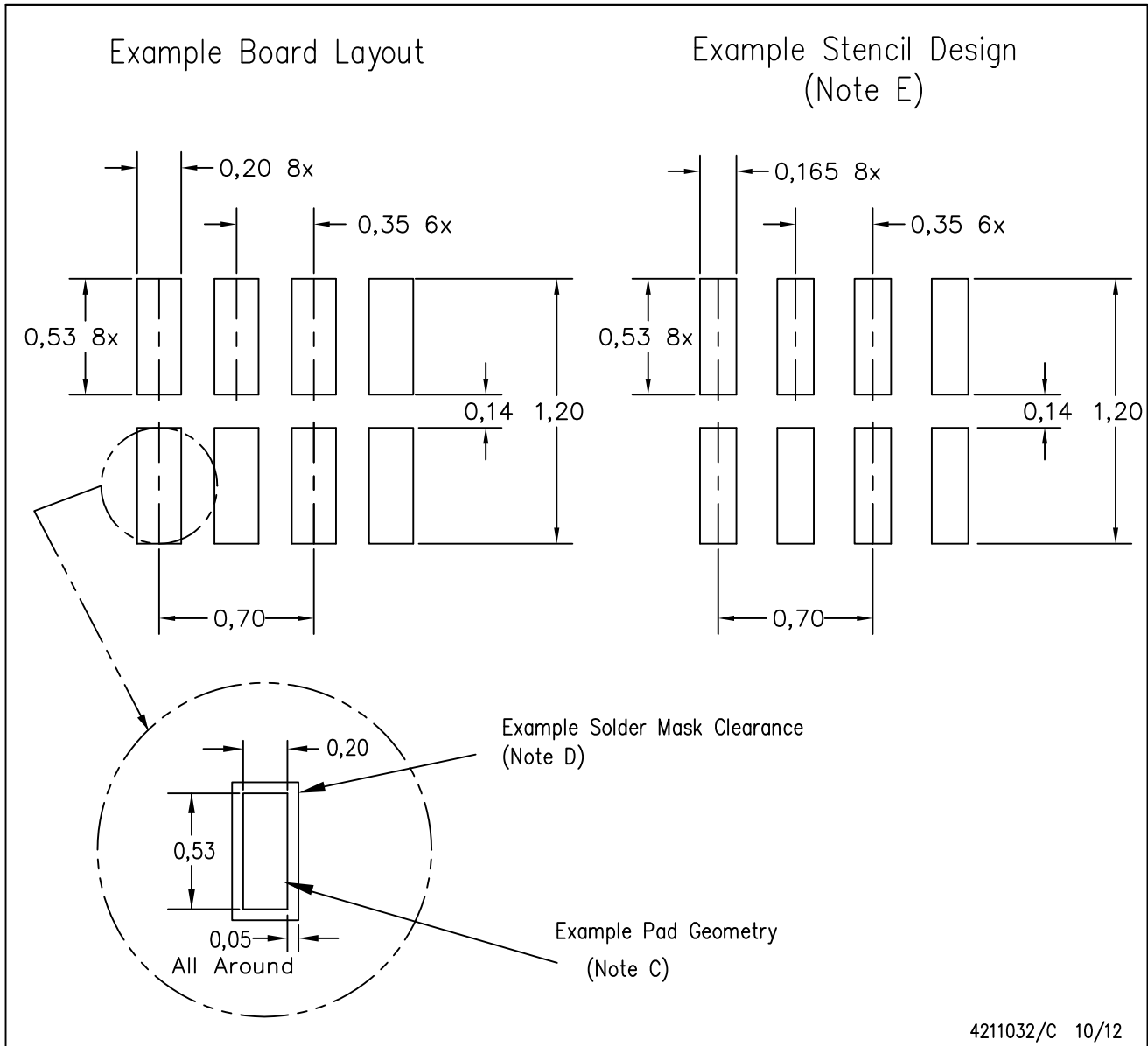

- NOTES:
- A. All linear dimensions are in millimeters.
 - B. This drawing is subject to change without notice.
 - C. Publication IPC-7351 is recommended for alternate designs.
 - D. Customers should contact their board fabrication site for minimum solder mask web tolerances between signal pads.
If 2 mil solder mask is outside PCB vendor capability, it is advised to omit solder mask.
 - E. Maximum stencil thickness 0,1016 mm (4 mils). All linear dimensions are in millimeters.
 - F. Laser cutting apertures with trapezoidal walls and also rounding corners will offer better paste release. Customers should contact their board assembly site for stencil design recommendations. Refer to IPC 7525 for stencil design considerations.
 - G. Over-printing land for acceptable area ratio is not viable due to land width and bridging potential. Customer may further reduce side aperture dimensions if stencil manufacturing process allows for sufficient release at smaller opening.
 - H. Suggest stencils cut with lasers such as Fiber Laser that produce the greatest positional accuracy.
 - I. Component placement force should be minimized to prevent excessive paste block deformation.

YFP0008

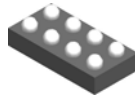

PACKAGE OUTLINE

DSBGA - 0.5 mm max height

DIE SIZE BALL GRID ARRAY

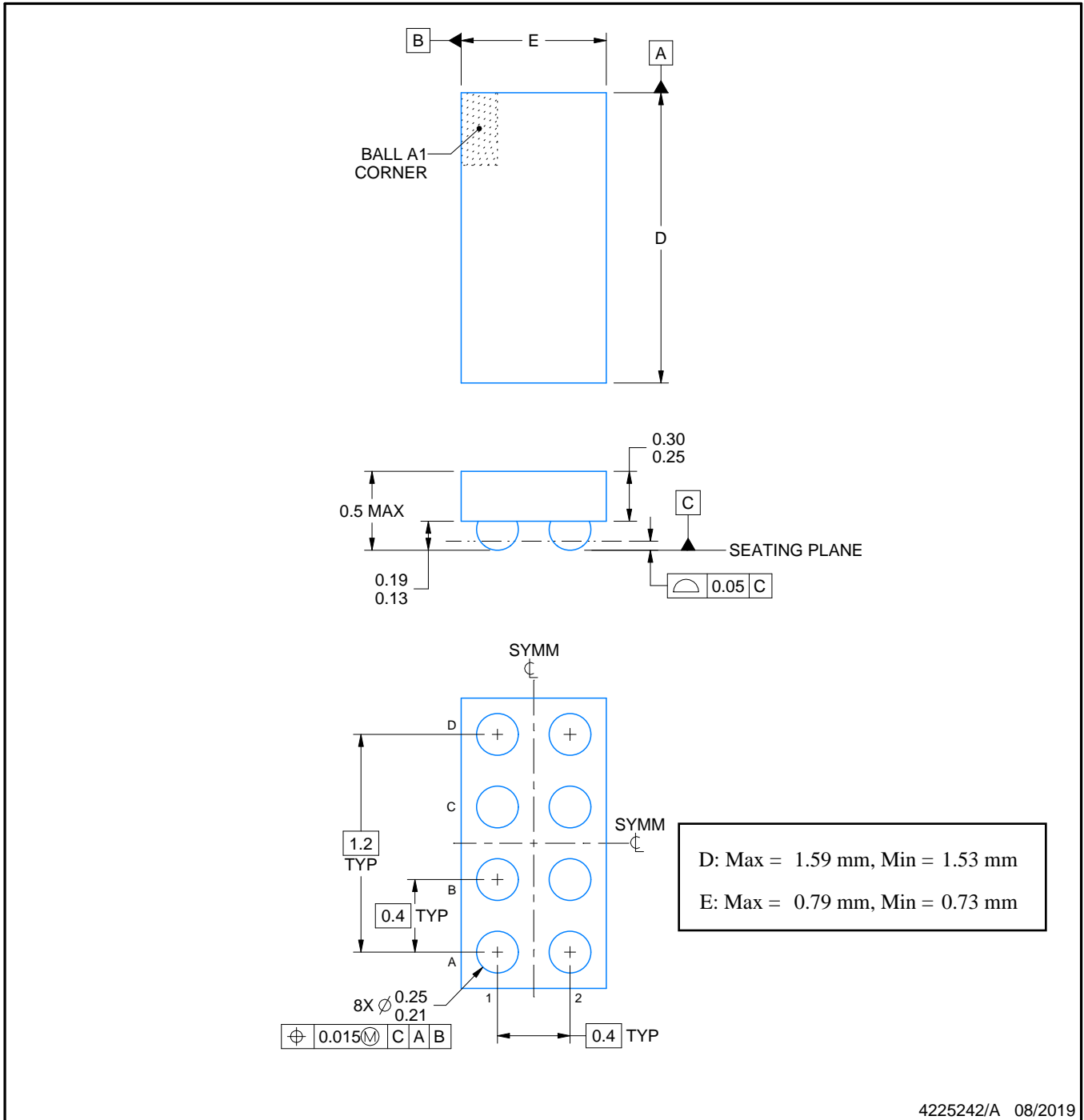

NOTES:

1. All linear dimensions are in millimeters. Any dimensions in parenthesis are for reference only. Dimensioning and tolerancing per ASME Y14.5M.
2. This drawing is subject to change without notice.

EXAMPLE BOARD LAYOUT

YFP0008

DSBGA - 0.5 mm max height

DIE SIZE BALL GRID ARRAY

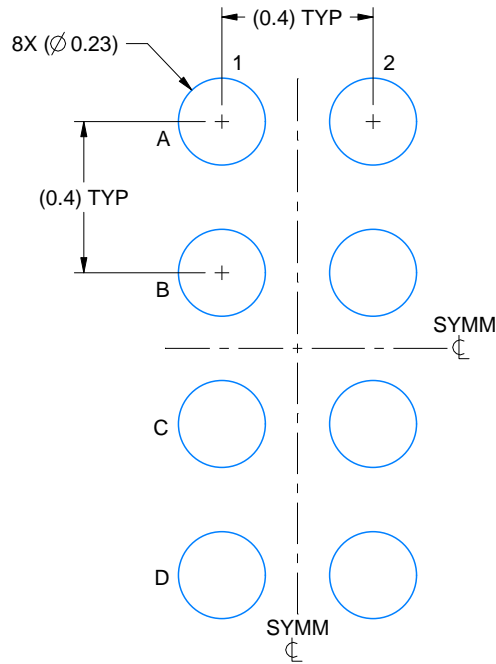

LAND PATTERN EXAMPLE
EXPOSED METAL SHOWN
SCALE: 50X

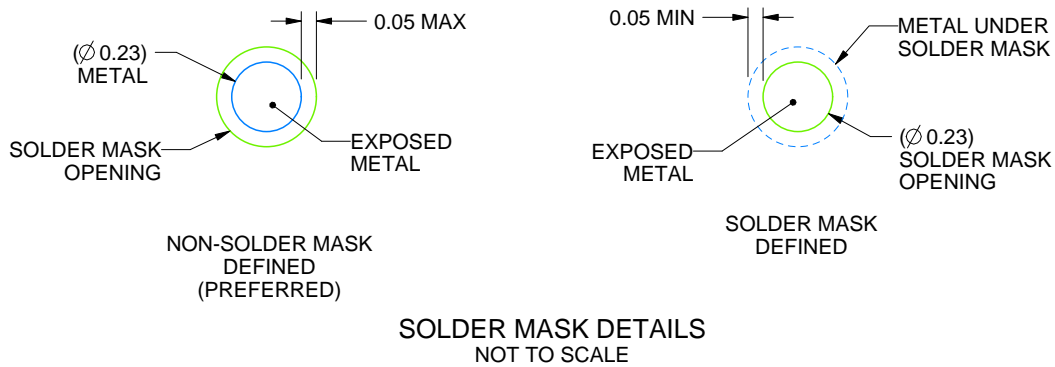

SOLDER MASK DETAILS
NOT TO SCALE

4225242/A 08/2019

NOTES: (continued)

- Final dimensions may vary due to manufacturing tolerance considerations and also routing constraints. See Texas Instruments Literature No. SNVA009 (www.ti.com/lit/snva009).

EXAMPLE STENCIL DESIGN

YFP0008

DSBGA - 0.5 mm max height

DIE SIZE BALL GRID ARRAY

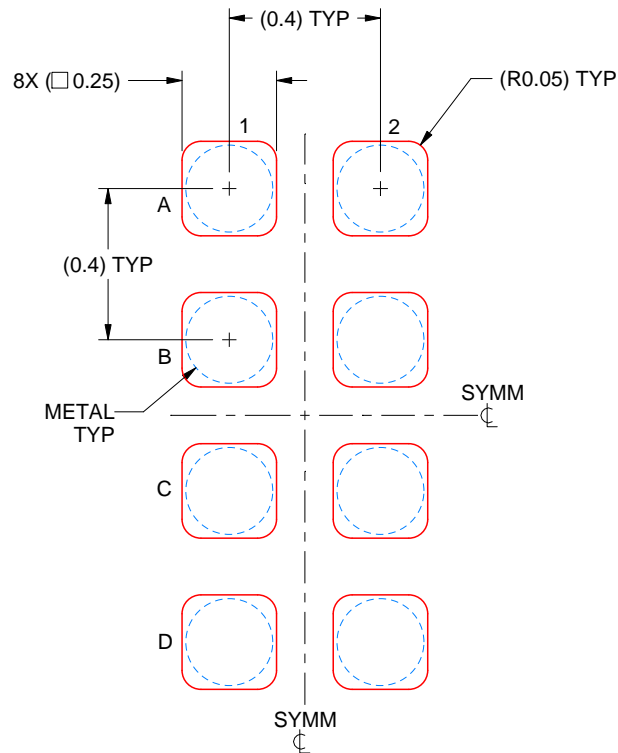

SOLDER PASTE EXAMPLE
BASED ON 0.1 mm THICK STENCIL
SCALE: 50X

4225242/A 08/2019

NOTES: (continued)

4. Laser cutting apertures with trapezoidal walls and rounded corners may offer better paste release.

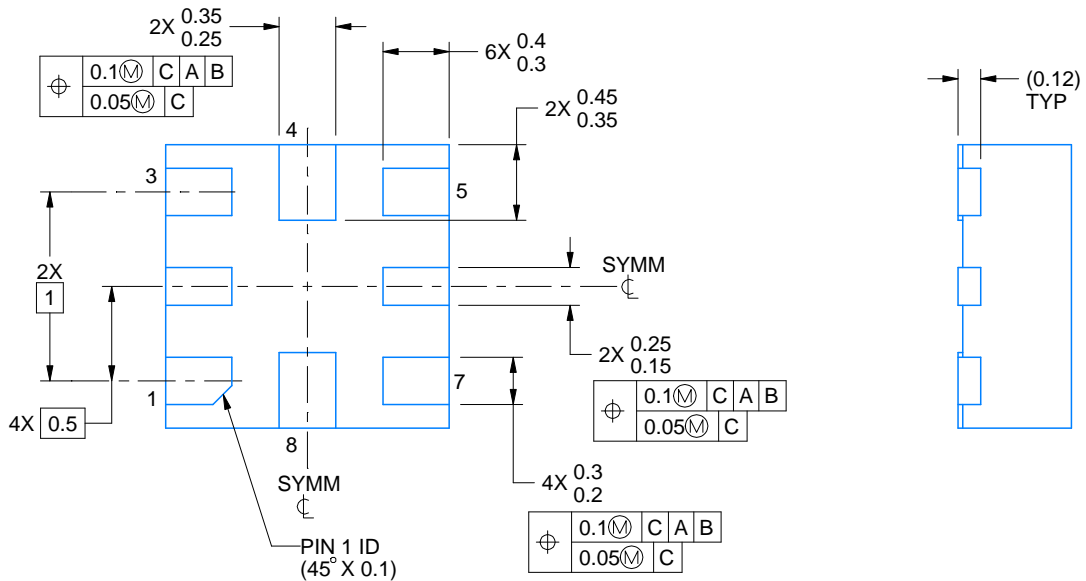
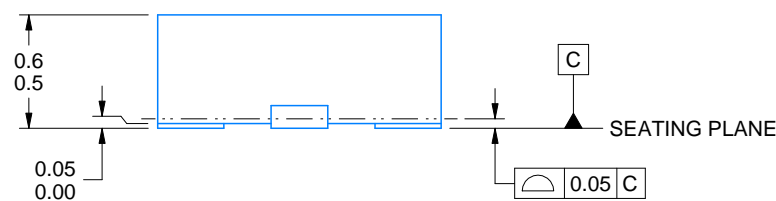
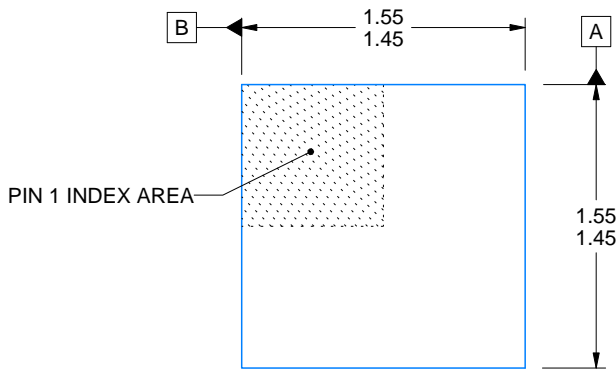
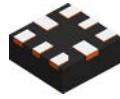

4220323/B 03/2018

NOTES:

1. All linear dimensions are in millimeters. Any dimensions in parenthesis are for reference only. Dimensioning and tolerancing per ASME Y14.5M.
2. This drawing is subject to change without notice.

EXAMPLE BOARD LAYOUT

RSE0008A

UQFN - 0.6 mm max height

PLASTIC QUAD FLATPACK - NO LEAD

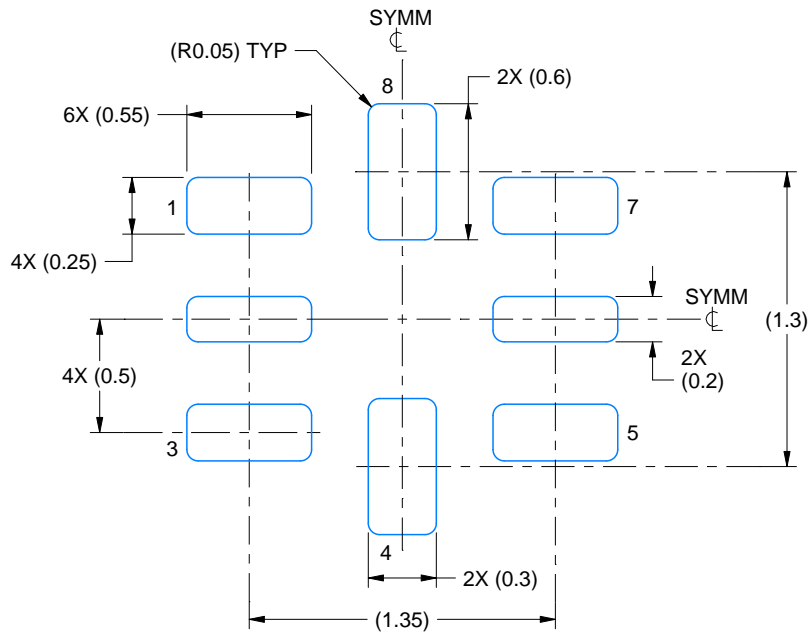

LAND PATTERN EXAMPLE
SCALE:30X

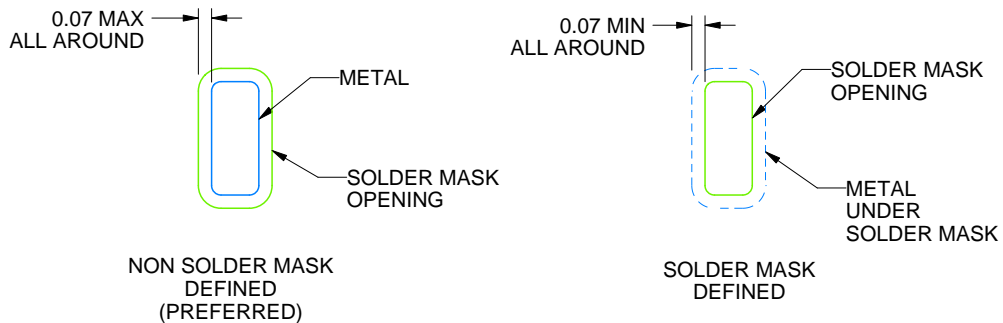

SOLDER MASK DETAILS
NOT TO SCALE

4220323/B 03/2018

NOTES: (continued)

3. For more information, see Texas Instruments literature number SLUA271 (www.ti.com/lit/slua271).

EXAMPLE STENCIL DESIGN

RSE0008A

UQFN - 0.6 mm max height

PLASTIC QUAD FLATPACK - NO LEAD

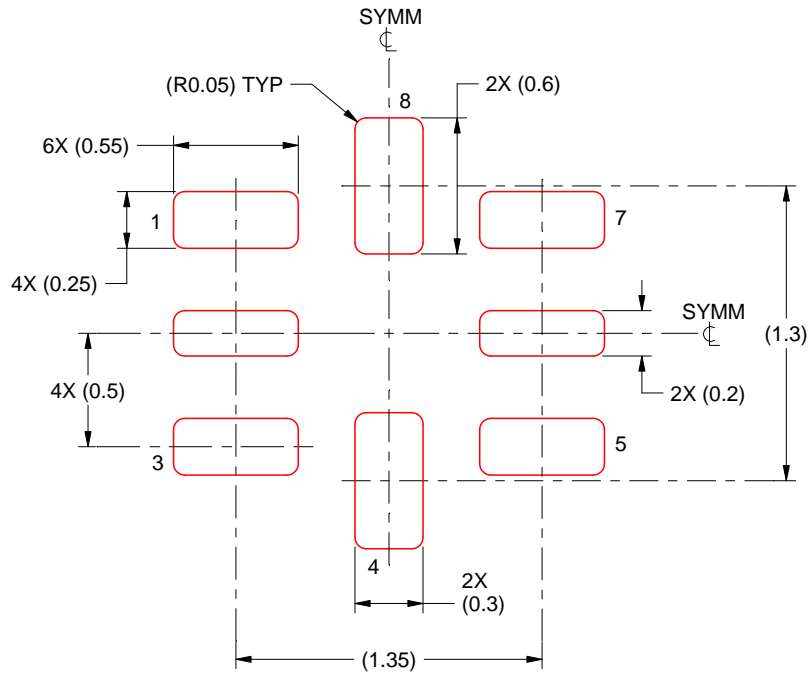

SOLDER PASTE EXAMPLE
BASED ON 0.1 mm THICKNESS
SCALE: 30X

4220323/B 03/2018

NOTES: (continued)

5. Laser cutting apertures with trapezoidal walls and rounded corners may offer better paste release. IPC-7525 may have alternate design recommendations.

IMPORTANT NOTICE AND DISCLAIMER

TI PROVIDES TECHNICAL AND RELIABILITY DATA (INCLUDING DATASHEETS), DESIGN RESOURCES (INCLUDING REFERENCE DESIGNS), APPLICATION OR OTHER DESIGN ADVICE, WEB TOOLS, SAFETY INFORMATION, AND OTHER RESOURCES "AS IS" AND WITH ALL FAULTS, AND DISCLAIMS ALL WARRANTIES, EXPRESS AND IMPLIED, INCLUDING WITHOUT LIMITATION ANY IMPLIED WARRANTIES OF MERCHANTABILITY, FITNESS FOR A PARTICULAR PURPOSE OR NON-INFRINGEMENT OF THIRD PARTY INTELLECTUAL PROPERTY RIGHTS.

These resources are intended for skilled developers designing with TI products. You are solely responsible for (1) selecting the appropriate TI products for your application, (2) designing, validating and testing your application, and (3) ensuring your application meets applicable standards, and any other safety, security, or other requirements. These resources are subject to change without notice. TI grants you permission to use these resources only for development of an application that uses the TI products described in the resource. Other reproduction and display of these resources is prohibited. No license is granted to any other TI intellectual property right or to any third party intellectual property right. TI disclaims responsibility for, and you will fully indemnify TI and its representatives against, any claims, damages, costs, losses, and liabilities arising out of your use of these resources.

TI's products are provided subject to TI's Terms of Sale (www.ti.com/legal/termsofsale.html) or other applicable terms available either on ti.com or provided in conjunction with such TI products. TI's provision of these resources does not expand or otherwise alter TI's applicable warranties or warranty disclaimers for TI products.

Mailing Address: Texas Instruments, Post Office Box 655303, Dallas, Texas 75265
Copyright © 2020, Texas Instruments Incorporated