

KPK-3520SURC HYPER RED

### Features

- 3.5mmX2.0mm SMT LED, 1.3mm THICKNESS.
- LOW POWER CONSUMPTION.
- WIDE VIEWING ANGLE.
- IDEAL FOR BACKLIGHT AND INDICATOR.
- VARIOUS COLORS AND LENS TYPES AVAILABLE.
- PACKAGE : 2000PCS / REEL.

### Description

The Hyper Red source color devices are made with DH InGaAlP on GaAs substrate Light Emitting Diode.

### Package Dimensions

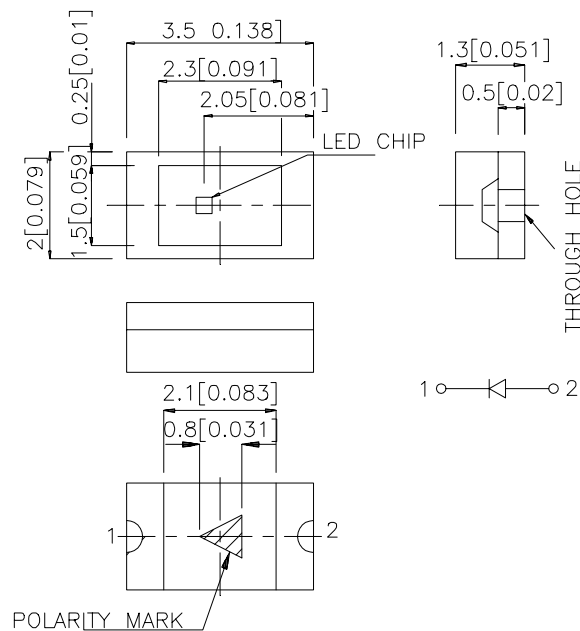

#### Notes:

1. All dimensions are in millimeters (inches).
2. Tolerance is  $\pm 0.2(0.0079)$  unless otherwise noted.
3. Lead spacing is measured where the lead emerge package.
4. Specifications are subject to change without notice.

## Selection Guide

Part No.	Dice	Lens Type	Iv (mcd) @ 20 mA		Viewing Angle
			Min.	Typ.	2θ1/2
KPK-3520SURC	HYPER RED ( InGaAlP )	WATER CLEAR	90	300	120°

Note:

1. θ1/2 is the angle from optical centerline where the luminous intensity is 1/2 the optical centerline value.

## Electrical / Optical Characteristics at T<sub>A</sub>=25°C

Symbol	Parameter	Device	Typ.	Max.	Units	Test Conditions
λ <sub>peak</sub>	Peak Wavelength	Hyper Red	640		nm	IF=20mA
λ <sub>D</sub>	Dominate Wavelength	Hyper Red	628		nm	IF=20mA
Δλ <sub>1/2</sub>	Spectral Line Halfwidth	Hyper Red	27		nm	IF=20mA
C	Capacitance	Hyper Red	45		pF	VR=0V;f=1MHz
V <sub>F</sub>	Forward Voltage	Hyper Red	1.9	2.5	V	IF=20mA
I <sub>R</sub>	Reverse Current	Hyper Red		10	μA	VR = 5V

## Absolute Maximum Ratings at T<sub>A</sub>=25°C

Parameter	Hyper Red	Units
Power dissipation	170	mW
DC Forward Current	30	mA
Peak Forward Current [1]	185	mA
Reverse Voltage	5	V
Operating/Storage Temperature	-40°C To +85°C	

Note:

1. 1/10 Duty Cycle, 0.1ms Pulse Width.

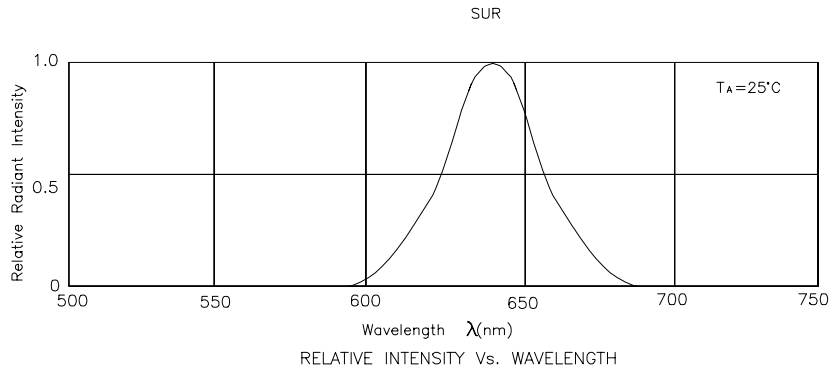

## Hyper Red KPK-3520SURC

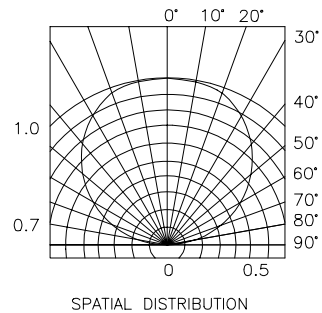
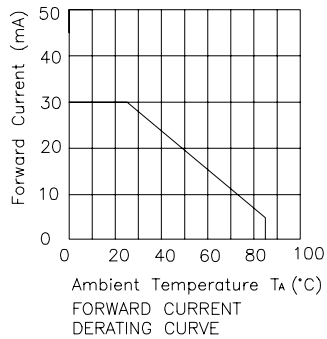
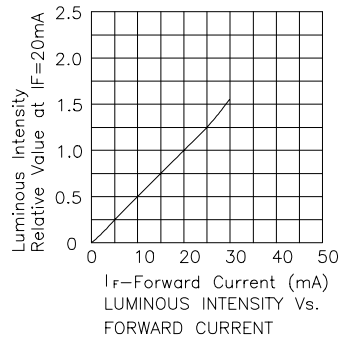
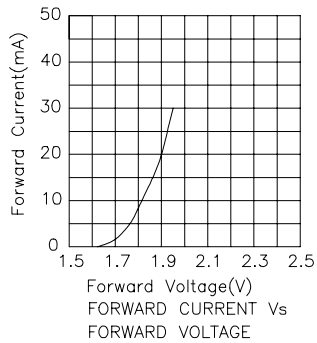

## KPK-3520SURC SMT Reflow Soldering Instructions

Number of reflow process shall be less than 2 times and cooling process to normal temperature is required between first and second soldering process.



### Recommended Soldering Pattern (Units : mm)

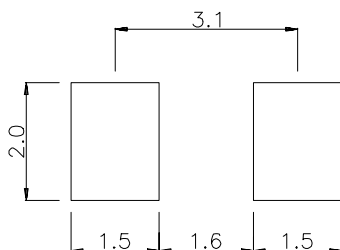

### Tape Specifications (Units : mm)

