

Data sheet

Commercial Art.No.: 25.790.0353.0

Printed circuit board terminal 8158 / 3 TOP H OB

PCB terminal with tension spring connection, 3 poles, with solder pin (3.5mm), max. cross section: 2.5 mm², pitch: 5 mm, type of packing: carton, color: grey



Commercial Art.No.	25.790.0353.0
EAN	4015573518834
Order Unit	100

Certificates / Approvals



Technical data

General

Modular spacing	5 mm
Connection type	spring clamp connection
Soldering process	Wave soldering
Packaging	Carton
Number of poles	3
Conductor to circuit board	180°
Number of levels	1
Integrated test socket	yes
Insulation plate	No
Retaining pins	No
Marking	No

Technical data

Nominal cross section	2.5 mm ²
Rated current	16 A
Overvoltage Category I	1000 V
Overvoltage Category II	690 V
Overvoltage Category III	250 V
Rated impulse voltage	4 kV
Wire strip length	9 mm

Connection Data

Minimum cross section solid	0.14 mm ²
Maximum cross section solid	4 mm ²
Minimum cross section fine stranded	0.14 mm ²
Maximum cross section fine stranded	2.5 mm ²
Wire strip length	9 mm

Technical Data UL/CSA

Cross section UL	30-12 AWG
Voltage UL	300 V
Current field wiring	20 A
Current factory wiring	20 A
Cross section CSA	22-12 AWG
Voltage CSA	300 V
Current CSA	20 A

Other

Type of insulation material	Thermoplastic
Color	Grey
Height	17.8 mm
Length	16.5 mm
Depth	15.45 mm
Material attachment screw	None
Material contact base	E-Cu
Material contact surface	Sn

Classification

ECLASS 11	
ECLASS 8.1	27440401
ETIM 7.0	EC002643
ETIM 6.0	EC002643
ETIM 5.0	EC002643
ETIM 4.0	EC002643

Product compliance

ROHS conformity status	Compliant
REACH-SVHC conformity status	Compliant

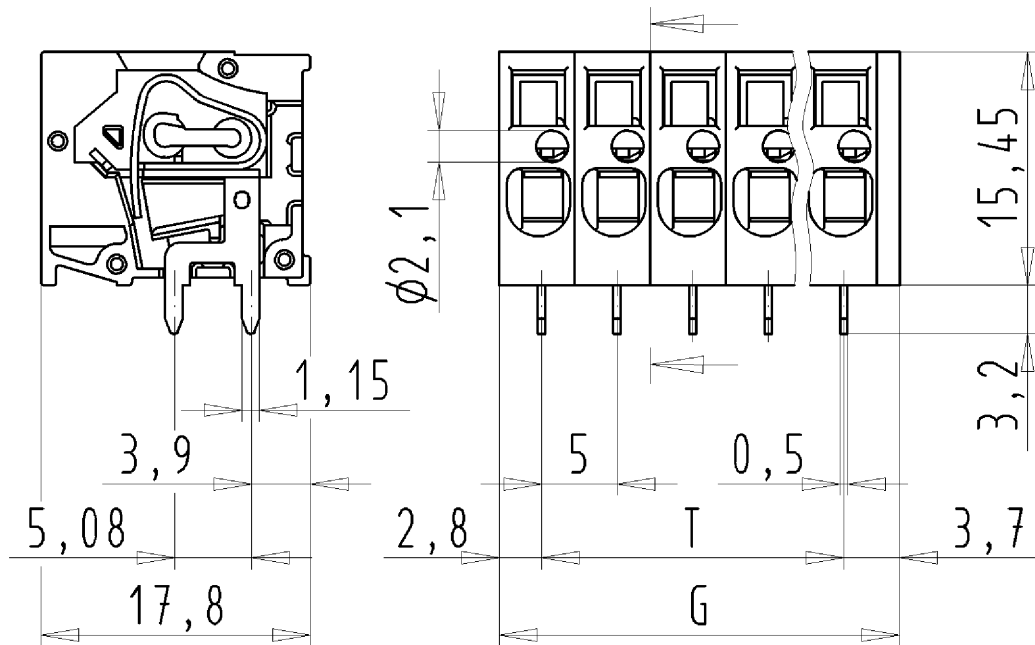

für folgende Tabellen-Zchnng.
 25.790.2453.0 8158/... TOP H

LP.KLEMME
 25.790.0253.0 10W
 26.11.2007 DÜT
 M 2:1