

Data sheet

Commercial Art.No.: 25.173.0353.0

Printed circuit board terminal 8291 / 3 ZN OB

PCB terminal with screw connection with rising cage clamp system, 3 poles, with insulating plate, with solder pin (3.5mm), max. cross section: 2.5 mm², pitch: 5.08 mm, type of packing: carton, color: grey



Commercial Art.No.	25.173.0353.0
EAN	4015573177680
Order Unit	100

Certificates / Approvals



Technical data

General

Modular spacing	5.08 mm
Connection type	screw connection
Soldering process	Wave soldering
Packaging	Carton
Number of poles	3
Conductor to circuit board	180°
Number of levels	1
Integrated test socket	yes
Insulation plate	yes
Retaining pins	yes
Marking	No

Technical data

Nominal cross section	2.5 mm ²
Rated current	16 A
Overvoltage Category I	1000 V
Overvoltage Category II	690 V
Overvoltage Category III	250 V
Rated impulse voltage	4 kV
Wire strip length	6.5 mm

Connection Data

Minimum cross section solid	0.14 mm ²
Maximum cross section solid	4 mm ²
Minimum cross section fine stranded	0.14 mm ²

Maximum cross section fine stranded	2.5 mm ²
Wire strip length	6.5 mm

Technical Data UL/CSA

Cross section UL	22-12 AWG
Voltage UL	300 V
Current field wiring	20 A
Current factory wiring	30 A
Cross section CSA	22-12 AWG
Voltage CSA	300 V
Current CSA	25 A

Other

Type of insulation material	Thermoplastic
Color	Grey
Height	16 mm
Length	16.09 mm
Depth	9.5 mm
Material attachment screw	Steel
Material contact base	E-Cu
Material contact surface	Sn

Classification

ECLASS 11	
ECLASS 8.1	27440401
ETIM 7.0	EC002643
ETIM 6.0	EC002643
ETIM 5.0	EC002643
ETIM 4.0	EC002643

Product compliance

ROHS conformity status	Compliant/Exempted
ROHS exceptions	III-6(c)
REACH-SVHC conformity status	Duty-To-Declare
REACH-SVHC substances	Lead
REACH-SVHC CAS numbers	7439-92-1

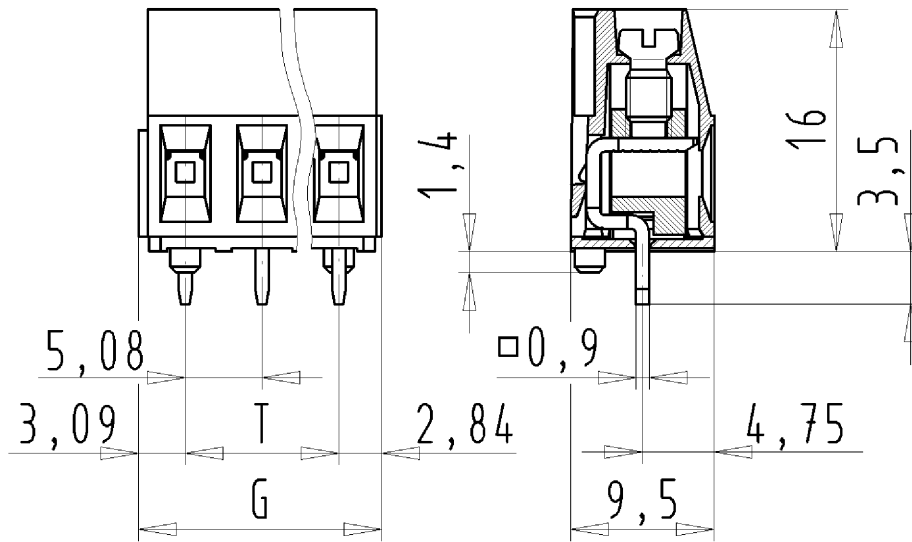

für folgende Tabellen-Zchnng.:
25.173.0353.F 8291 /.. ZN OB

LP.KLEMME
25.173.0253.0 10W
14.11.2007 DÜT
M 2:1