

CUSTOMER : _____

DATE : Jul. 16, 2014

REV : _____

PRODUCT FAMILY DATA SHEET



5152 Family

Top View Type White SMD LED

MODEL NAME : LEMWS51R Series

RoHS
Compliant

CONTENTS

1. Features	-----	3
2. Applications	-----	3
3. Outline Dimensions	-----	3
4. Absolute Maximum Ratings	-----	4
5. Electro – Optical Characteristics	-----	4 ~ 5
6. Forward Voltage Bins	-----	5
7. Chromaticity Bins	-----	6 ~ 9
8. Typical Characteristic Curves	-----	10 ~ 18
9. Reliability Test Items and Conditions	-----	19
10. Packing and Labeling of Products	-----	20 ~ 24
11. Cautions on Use	-----	25 ~ 28
12. Disclaimers	-----	28
Appendix. Product Nomenclature	-----	29

1. Features

- Light Color : White
- Lead Frame Type LED Package : 5.1×5.2×1.0 (L×W×H) [Unit : mm]
- Viewing angle : 120°
- Chip Material : InGaN
- Soldering Methods : Reflow Soldering
- Taping : 12 mm conductive black carrier tape & antistatic clear cover tape.

2,000pcs/reel, Φ203 mm wheel

2. Applications

- Indoor Lighting : Ambient Light, LED Tube and Ceiling Light

3. Outline Dimensions

(Unit : mm)

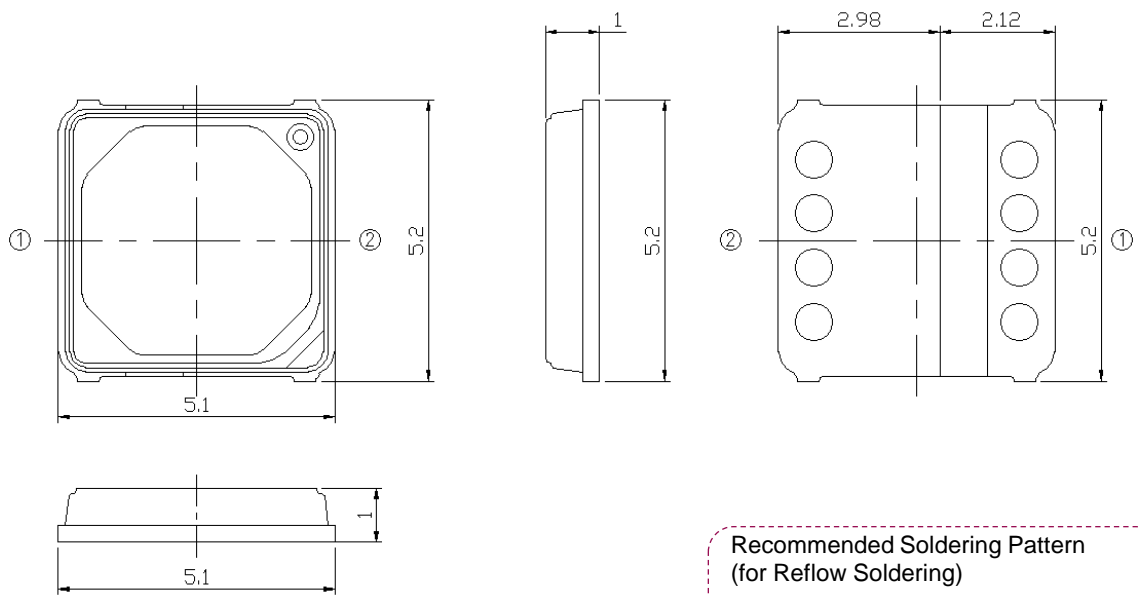

Pad Configuration

- ① Anode Pad
- ② Cathode Pad

Internal Circuit



Recommended Soldering Pattern
(for Reflow Soldering)

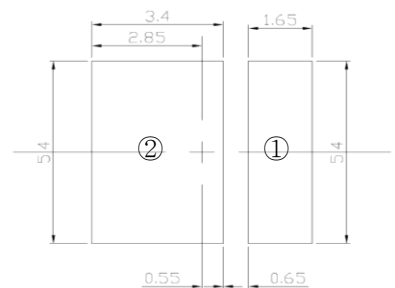

Tolerances Unless Dimension $\pm 0.1\text{mm}$

4. Absolute Maximum Ratings

(Ta = 25℃)

Item	Symbol	Rating	Unit
Forward Current	If	200	mA
Peak Pulse Forward Current*1)	I _{fp}	260	mA
Operating Temperature	Topr	-40 ~ +85	℃
Storage Temperature	Tstg	-40 ~ +100	℃
Junction Temperature	Tj	110	℃
Soldering Temperature	JEDEC-J-STD-020		
ESD Classification	Class 2 (JESD22-A114)		

*1) Pulse width ≤10ms and duty cycle ≤10%

※ Operating the LED beyond the listed maximum ratings may affect device reliability and cause permanent damage.

These or any other conditions beyond those indicated under recommended operating conditions are not implied.

The exposure to the absolute maximum rated conditions may affect device reliability.

※ The LEDs are not designed to be driven in reverse bias.

5. Electro - Optical Characteristics

(Ta = 25℃, If = 65mA)

Nominal CCTs	Min CRI	Product Code	Flux Code		Luminous Flux (lm)	
			Flux Class ¹⁾	Flux Bin ²⁾	Min	Max
6500K (F)	80	LEMWS51R80FZ21A0	1	R1	25.9	28.8
	80	LEMWS51R80FZ2AA0	A	R	28.8	31.2
	80	LEMWS51R80FZ2CA0	C	R	31.2	35.3
5700K (G)	80	LEMWS51R80GZ21A0	1	R1	25.9	28.8
	80	LEMWS51R80GZ2AA0	A	R	28.8	31.6
	80	LEMWS51R80GZ2CA0	C	R	31.6	35.6
5000K (H)	80	LEMWS51R80HZ21A0	1	R1	25.9	28.8
	80	LEMWS51R80HZ2AA0	A	R	28.8	31.9
	80	LEMWS51R80HZ2CA0	C	R	31.9	36.0
4000K (J)	80	LEMWS51R80JZ31A0	1	R1	25.0	27.8
	80	LEMWS51R80JZ3AA0	A	R	27.8	30.6
	80	LEMWS51R80JZ3CA0	C	R	30.6	34.6
3500K (K)	80	LEMWS51R80KZ31A0	1	R1	24.0	26.9
	80	LEMWS51R80KZ3AA0	A	R	26.9	30.0
	80	LEMWS51R80KZ3CA0	C	R	30.0	33.9
3000K (L)	80	LEMWS51R80LZ31A0	1	R1	24.0	26.9
	80	LEMWS51R80LZ3AA0	A	R	26.9	29.7
	80	LEMWS51R80LZ3CA0	C	R	29.7	33.5
2700K (M)	80	LEMWS51R80MZ31A0	1	R1	23.0	25.9
	80	LEMWS51R80MZ3AA0	A	R	25.9	27.3
	80	LEMWS51R80MZ3CA0	C	R	27.3	30.8

*1) "Flux Class" is the 14th digit in the Product Code which is used for ordering 5152 Family LED's

*2) "Flux Bin" is the flux as referenced on the product label (refer to 10-4 in section 10)

5. Electro - Optical Characteristics

(Ta = 25℃, If = 65mA)

Item	Symbol	Flux Code	CCT	Min.	Typ.	Max.	Unit
Forward Voltage (Vf) (@65mA, Ta=25℃)	Vf	1R1	All	2.70	-	3.00	V
		AR	All	2.70	-	3.00	V
		CR	All	2.70	-	3.00	V
Color	Cx / Cy	All	All	Refer to 'Chromaticity Bins'			-
Viewing Angle	2Θ1/2	All	All	-	120	-	deg
Color Rendering Index (Ra)	Ra	All	All	80	-	-	-
Thermal Resistance, Junction to Solder Point	Rth j-s	All	All	-	15	-	℃/W
Typical Temperature Coefficient of Forward Voltage ^{*1)}	ΔVf / ΔTj	All	All	-1.0	-	-3.0	mV/℃

*1) Measured at Ta between 25℃ and 85℃.

※ These values are measured by the LG Innotek optical spectrum analyzer within the following tolerances.

Luminous Flux (Φv) : ± 7%, Forward Voltage (Vf) : ± 0.1V, Color Value : ± 0.005, CRI Value : ± 2,

※ Although all LEDs are tested by LG Innotek equipment, some values may vary slightly depending on the conditions of the test equipment.

6. Forward Voltage Bins

(Ta = 25℃, If = 65mA)

Bin Code	8A (2.70~ 2.75)	8B (2.75~ 2.80)	9A (2.80~ 2.85)	9B (2.85~ 2.90)	0A (2.90~ 2.95)	0B (2.95~ 3.00)
Ranks by Flux Code						
1R1 / AR / CR						

※ Bin Structure : Please refer to the following example as below;

Example#1) Bin Code : R1-L11-9B (Flux Bin Code = R1, Color Coordinate Bin Code = L11, Vf Bin Code = 9B)

Example#2) Bin Code : R-L11-8B (Flux Bin Code = R, Color Coordinate Bin Code = L11, Vf Bin Code = 8B)

7. Chromaticity Bins (Cool White)

LG Innotek complies with the ANSI C78.377A standard for its chromaticity bin structure. For each ANSI quadrangle for the CCT range of 4500K to 6500K, LG Innotek provides 9 micro bins.

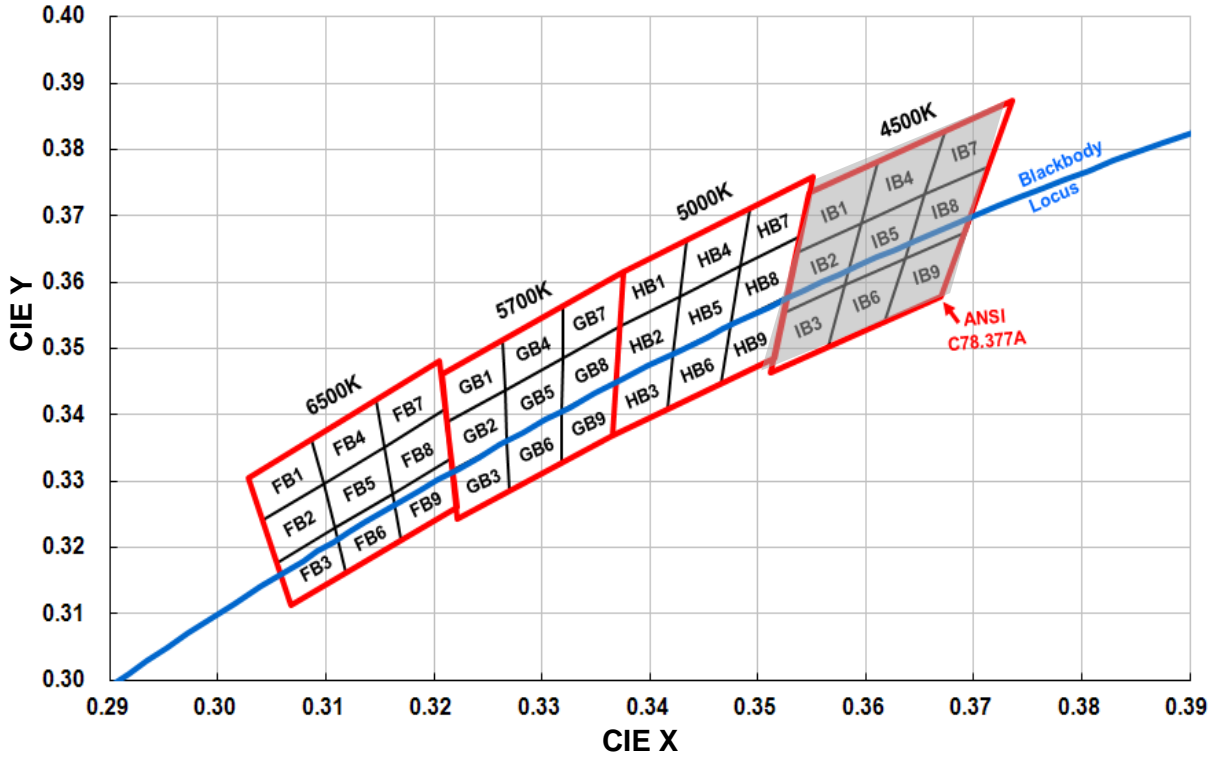

Bin	CIE X	CIE Y	Bin	CIE X	CIE Y	Bin	CIE X	CIE Y	Bin	CIE X	CIE Y
FB1	0.3028	0.3304	GB1	0.3207	0.3462	HB1	0.3376	0.3616	IB1	0.3548	0.3736
	0.3087	0.3363		0.3263	0.3513		0.3434	0.3664		0.3611	0.3782
	0.3098	0.3296		0.3266	0.3437		0.3428	0.3579		0.3595	0.3689
	0.3041	0.3240		0.3212	0.3389		0.3373	0.3534		0.3536	0.3646
FB2	0.3041	0.3240	GB2	0.3212	0.3389	HB2	0.3373	0.3534	IB2	0.3536	0.3646
	0.3098	0.3296		0.3266	0.3437		0.3428	0.3579		0.3595	0.3689
	0.3108	0.3229		0.3268	0.3361		0.3422	0.3494		0.3580	0.3596
	0.3055	0.3177		0.3217	0.3316		0.3369	0.3451		0.3524	0.3555
FB3	0.3055	0.3177	GB3	0.3217	0.3316	HB3	0.3369	0.3451	IB3	0.3524	0.3555
	0.3108	0.3229		0.3268	0.3361		0.3422	0.3494		0.3580	0.3596
	0.3119	0.3162		0.3270	0.3285		0.3416	0.3408		0.3565	0.3503
	0.3068	0.3113		0.3222	0.3243		0.3366	0.3369		0.3512	0.3465
FB4	0.3087	0.3363	GB4	0.3263	0.3513	HB4	0.3434	0.3664	IB4	0.3611	0.3782
	0.3146	0.3422		0.3320	0.3565		0.3493	0.3712		0.3673	0.3828
	0.3154	0.3352		0.3319	0.3485		0.3484	0.3624		0.3655	0.3732
	0.3098	0.3296		0.3266	0.3437		0.3428	0.3579		0.3595	0.3689

7. Chromaticity Bins (Continued)

Bin	CIE X	CIE Y	Bin	CIE X	CIE Y	Bin	CIE X	CIE Y	Bin	CIE X	CIE Y
FB5	0.3098	0.3296	GB5	0.3266	0.3437	HB5	0.3428	0.3579	IB5	0.3595	0.3689
	0.3154	0.3352		0.3319	0.3485		0.3484	0.3624		0.3655	0.3732
	0.3162	0.3282		0.3319	0.3406		0.3474	0.3536		0.3636	0.3636
	0.3108	0.3229		0.3268	0.3361		0.3422	0.3494		0.3580	0.3596
FB6	0.3108	0.3229	GB6	0.3268	0.3361	HB6	0.3422	0.3494	IB6	0.3580	0.3596
	0.3162	0.3282		0.3319	0.3406		0.3474	0.3536		0.3636	0.3636
	0.3170	0.3212		0.3318	0.3327		0.3465	0.3448		0.3617	0.3540
	0.3119	0.3162		0.3270	0.3285		0.3416	0.3408		0.3565	0.3503
FB7	0.3146	0.3422	GB7	0.3320	0.3565	HB7	0.3493	0.3712	IB7	0.3673	0.3828
	0.3205	0.3481		0.3376	0.3616		0.3551	0.3760		0.3736	0.3874
	0.3210	0.3408		0.3373	0.3534		0.3539	0.3669		0.3714	0.3775
	0.3154	0.3352		0.3319	0.3485		0.3484	0.3624		0.3655	0.3732
FB8	0.3154	0.3352	GB8	0.3319	0.3485	HB8	0.3484	0.3624	IB8	0.3655	0.3732
	0.3210	0.3408		0.3373	0.3534		0.3539	0.3669		0.3714	0.3775
	0.3216	0.3334		0.3369	0.3451		0.3527	0.3578		0.3692	0.3677
	0.3162	0.3282		0.3319	0.3406		0.3474	0.3536		0.3636	0.3636
FB9	0.3162	0.3282	GB9	0.3319	0.3406	HB9	0.3474	0.3536	IB9	0.3636	0.3636
	0.3216	0.3334		0.3369	0.3451		0.3527	0.3578		0.3692	0.3677
	0.3221	0.3261		0.3366	0.3369		0.3515	0.3487		0.3670	0.3578
	0.3170	0.3212		0.3318	0.3327		0.3465	0.3448		0.3617	0.3540

7. Chromaticity Bins (Neutral & Warm White)

LG Innotek complies with the ANSI C78.377A standard for its chromaticity bin structure. For each ANSI quadrangle for the CCT range of 2700K to 4000K, LG Innotek provides 16 micro bins.

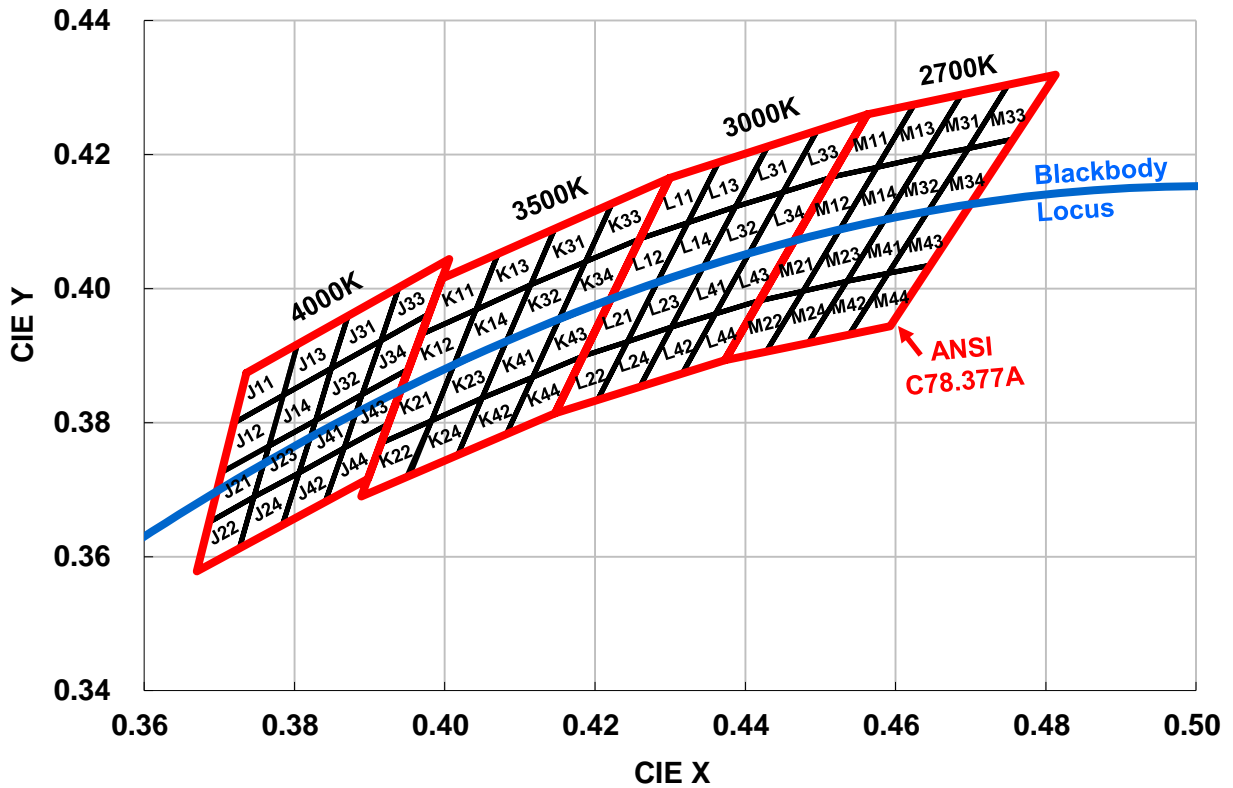

Bin	CIE X	CIE Y	Bin	CIE X	CIE Y	Bin	CIE X	CIE Y	Bin	CIE X	CIE Y
J11	0.3736	0.3874	K11	0.3996	0.4015	L11	0.4299	0.4165	M11	0.4562	0.4260
	0.3804	0.3917		0.4071	0.4052		0.4364	0.4189		0.4625	0.4275
	0.3785	0.3841		0.4041	0.3969		0.4323	0.4098		0.4575	0.4181
	0.3720	0.3800		0.3969	0.3932		0.4260	0.4075		0.4513	0.4166
J12	0.3720	0.3800	K12	0.3969	0.3932	L12	0.4260	0.4075	M12	0.4513	0.4166
	0.3785	0.3841		0.4041	0.3969		0.4323	0.4098		0.4575	0.4181
	0.3766	0.3765		0.4012	0.3885		0.4282	0.4008		0.4525	0.4087
	0.3703	0.3726		0.3941	0.3848		0.4221	0.3984		0.4465	0.4071
J13	0.3804	0.3917	K13	0.4071	0.4052	L13	0.4364	0.4189	M13	0.4625	0.4275
	0.3871	0.3959		0.4146	0.4089		0.4430	0.4212		0.4687	0.4289
	0.3849	0.3881		0.4114	0.4005		0.4387	0.4122		0.4637	0.4196
	0.3785	0.3841		0.4041	0.3969		0.4323	0.4098		0.4575	0.4181
J14	0.3785	0.3841	K14	0.4041	0.3969	L14	0.4323	0.4098	M14	0.4575	0.4181
	0.3849	0.3881		0.4114	0.4005		0.4387	0.4122		0.4637	0.4196
	0.3828	0.3803		0.4082	0.3922		0.4344	0.4032		0.4586	0.4103
	0.3766	0.3765		0.4012	0.3885		0.4282	0.4008		0.4525	0.4087

7. Chromaticity Bins (Continued)

Bin	CIE X	CIE Y	Bin	CIE X	CIE Y	Bin	CIE X	CIE Y	Bin	CIE X	CIE Y
J21	0.3703	0.3726	K21	0.3941	0.3848	L21	0.4221	0.3984	M21	0.4465	0.4071
	0.3766	0.3765		0.4012	0.3885		0.4282	0.4008		0.4525	0.4087
	0.3746	0.3689		0.3982	0.3803		0.4243	0.3921		0.4477	0.3996
	0.3687	0.3652		0.3915	0.3769		0.4184	0.3899		0.4419	0.3982
J22	0.3687	0.3652	K22	0.3915	0.3769	L22	0.4184	0.3899	M22	0.4419	0.3982
	0.3746	0.3689		0.3982	0.3803		0.4243	0.3921		0.4477	0.3996
	0.3727	0.3613		0.3950	0.3721		0.4203	0.3834		0.4428	0.3906
	0.3670	0.3578		0.3889	0.3690		0.4147	0.3814		0.4373	0.3893
J23	0.3766	0.3765	K23	0.4012	0.3885	L23	0.4282	0.4008	M23	0.4525	0.4087
	0.3828	0.3803		0.4082	0.3922		0.4344	0.4032		0.4586	0.4103
	0.3806	0.3725		0.4050	0.3837		0.4302	0.3943		0.4535	0.4011
	0.3746	0.3689		0.3982	0.3803		0.4243	0.3921		0.4477	0.3996
J24	0.3746	0.3689	K24	0.3982	0.3803	L24	0.4243	0.3921	M24	0.4477	0.3996
	0.3806	0.3725		0.4050	0.3837		0.4302	0.3943		0.4535	0.4011
	0.3784	0.3647		0.4017	0.3752		0.4260	0.3853		0.4483	0.3918
	0.3727	0.3613		0.3953	0.3721		0.4203	0.3834		0.4428	0.3906
J31	0.3871	0.3959	K31	0.4146	0.4089	L31	0.4430	0.4212	M31	0.4687	0.4289
	0.3939	0.4002		0.4223	0.4127		0.4496	0.4236		0.4750	0.4304
	0.3915	0.3922		0.4187	0.4040		0.4450	0.4144		0.4697	0.4209
	0.3849	0.3881		0.4114	0.4005		0.4387	0.4122		0.4637	0.4196
J32	0.3849	0.3881	K32	0.4114	0.4005	L32	0.4387	0.4122	M32	0.4637	0.4196
	0.3915	0.3922		0.4187	0.4040		0.4450	0.4144		0.4697	0.4209
	0.3890	0.3842		0.4151	0.3953		0.4404	0.4052		0.4643	0.4115
	0.3828	0.3803		0.4082	0.3922		0.4344	0.4032		0.4586	0.4103
J33	0.3939	0.4002	K33	0.4223	0.4127	L33	0.4496	0.4236	M33	0.4750	0.4304
	0.4006	0.4044		0.4299	0.4165		0.4562	0.4260		0.4813	0.4319
	0.3979	0.3962		0.4260	0.4075		0.4513	0.4166		0.4756	0.4223
	0.3915	0.3922		0.4187	0.4040		0.4450	0.4144		0.4697	0.4209
J34	0.3915	0.3922	K34	0.4187	0.4040	L34	0.4450	0.4144	M34	0.4697	0.4209
	0.3979	0.3962		0.4260	0.4075		0.4513	0.4166		0.4756	0.4223
	0.3952	0.3880		0.4221	0.3984		0.4465	0.4071		0.4700	0.4126
	0.3890	0.3842		0.4151	0.3953		0.4404	0.4052		0.4643	0.4115
J41	0.3828	0.3803	K41	0.4082	0.3922	L41	0.4344	0.4032	M41	0.4586	0.4103
	0.3890	0.3842		0.4151	0.3953		0.4404	0.4052		0.4643	0.4115
	0.3866	0.3762		0.4117	0.3868		0.4360	0.3962		0.4590	0.4023
	0.3806	0.3725		0.4050	0.3837		0.4302	0.3943		0.4535	0.4011
J42	0.3806	0.3725	K42	0.4050	0.3837	L42	0.4302	0.3943	M42	0.4535	0.4011
	0.3866	0.3762		0.4117	0.3868		0.4360	0.3962		0.4590	0.4023
	0.3841	0.3682		0.4082	0.3783		0.4316	0.3873		0.4538	0.3931
	0.3784	0.3647		0.4017	0.3752		0.4260	0.3853		0.4483	0.3918
J43	0.3890	0.3842	K43	0.4151	0.3953	L43	0.4404	0.4052	M43	0.4643	0.4115
	0.3952	0.3880		0.4221	0.3984		0.4465	0.4071		0.4700	0.4126
	0.3925	0.3798		0.4184	0.3899		0.4419	0.3982		0.4646	0.4035
	0.3866	0.3762		0.4117	0.3868		0.4360	0.3962		0.4590	0.4023
J44	0.3866	0.3762	K44	0.4117	0.3868	L44	0.4360	0.3962	M44	0.4590	0.4023
	0.3925	0.3798		0.4184	0.3899		0.4419	0.3982		0.4646	0.4035
	0.3898	0.3716		0.4147	0.3814		0.4373	0.3893		0.4593	0.3944
	0.3841	0.3682		0.4082	0.3783		0.4316	0.3873		0.4538	0.3931

8. Typical Characteristic Curves

- Forward Current vs. Forward Voltage

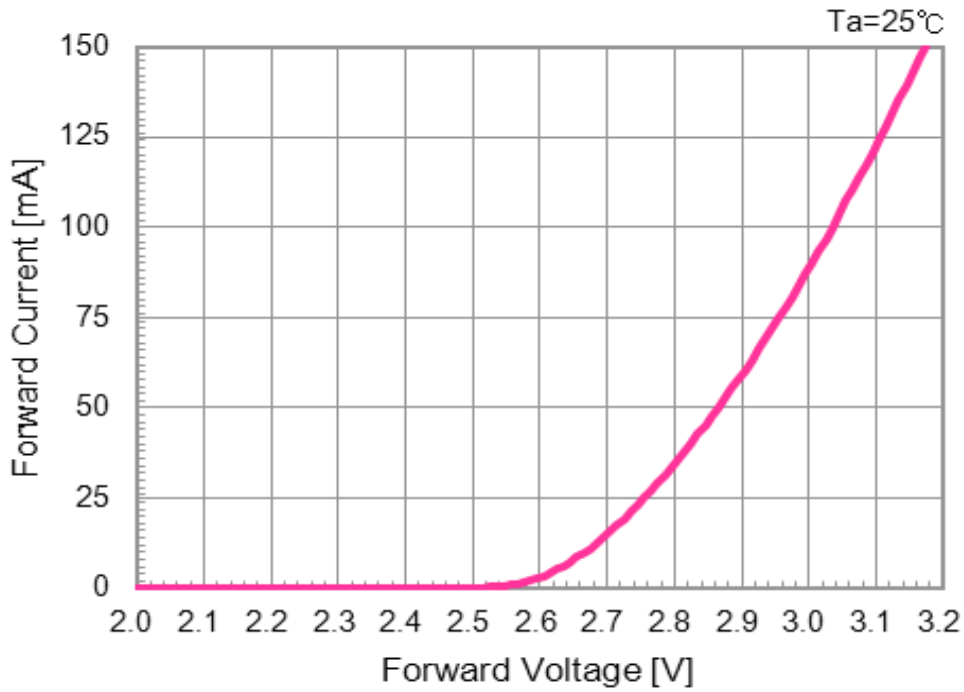

- Relative Luminous Flux vs. Forward Current

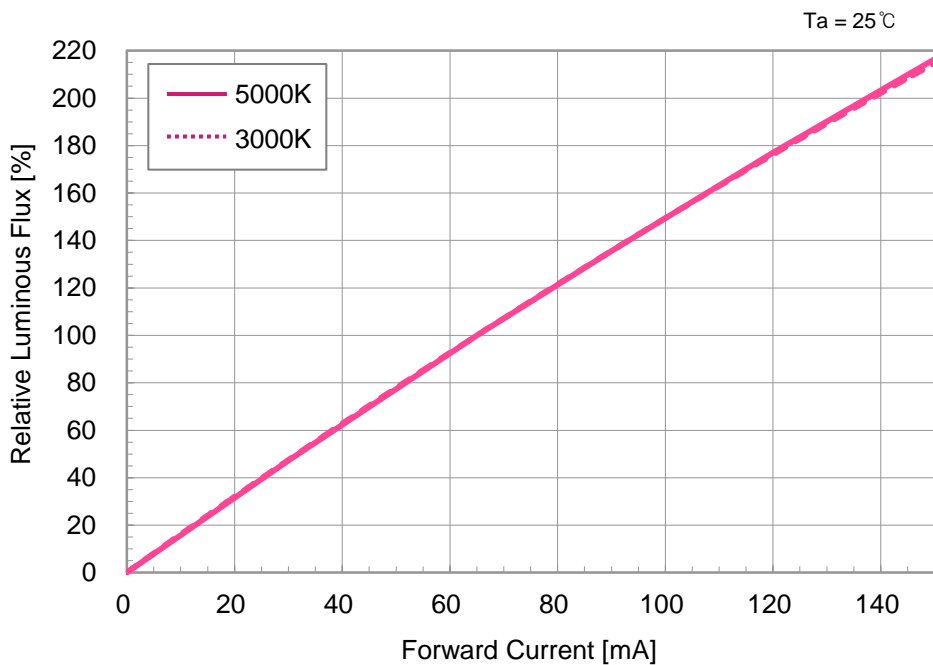

※ 5000K CCT data also applies to 5700K and 6500K CCTs and 3000K data also applies to 2700K, 3500K and 4000K CCTs.

8. Typical Characteristic Curves

- Spectrum

Ta=25°C, If=65mA

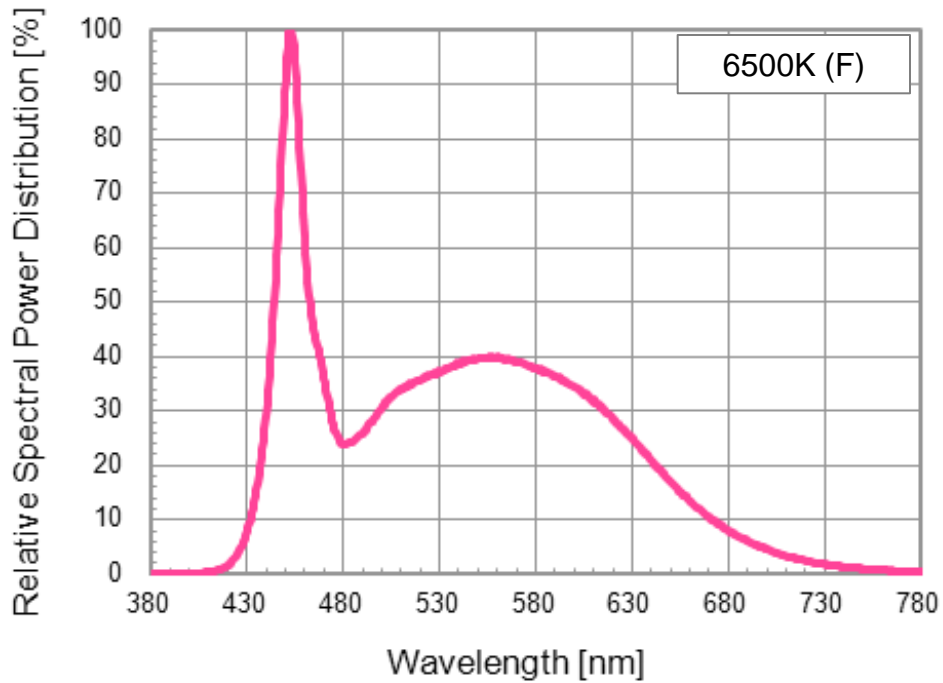

Ta=25°C, If=65mA

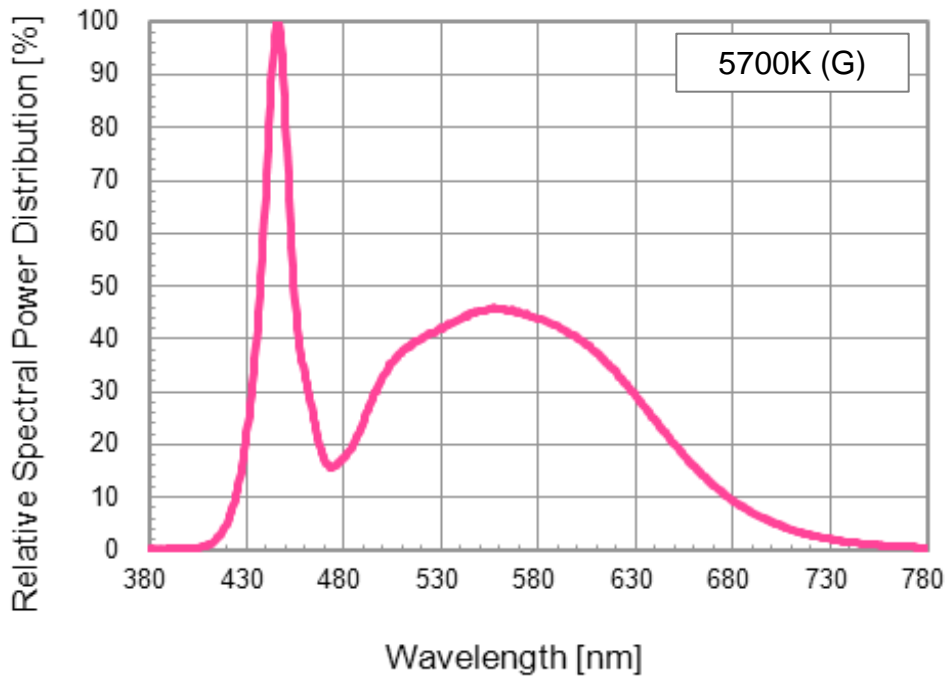

8. Typical Characteristic Curves

- Spectrum

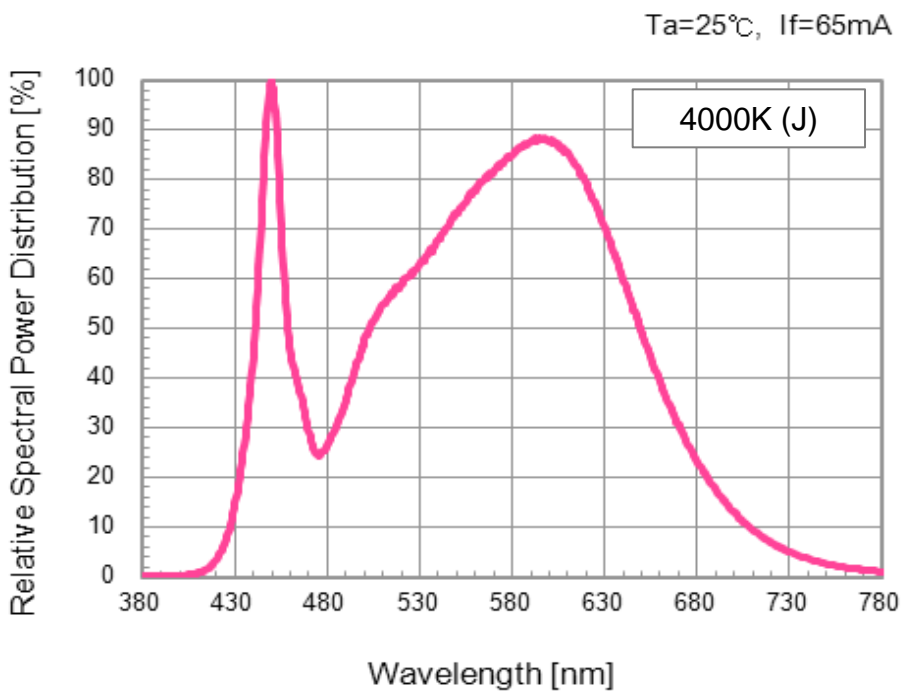
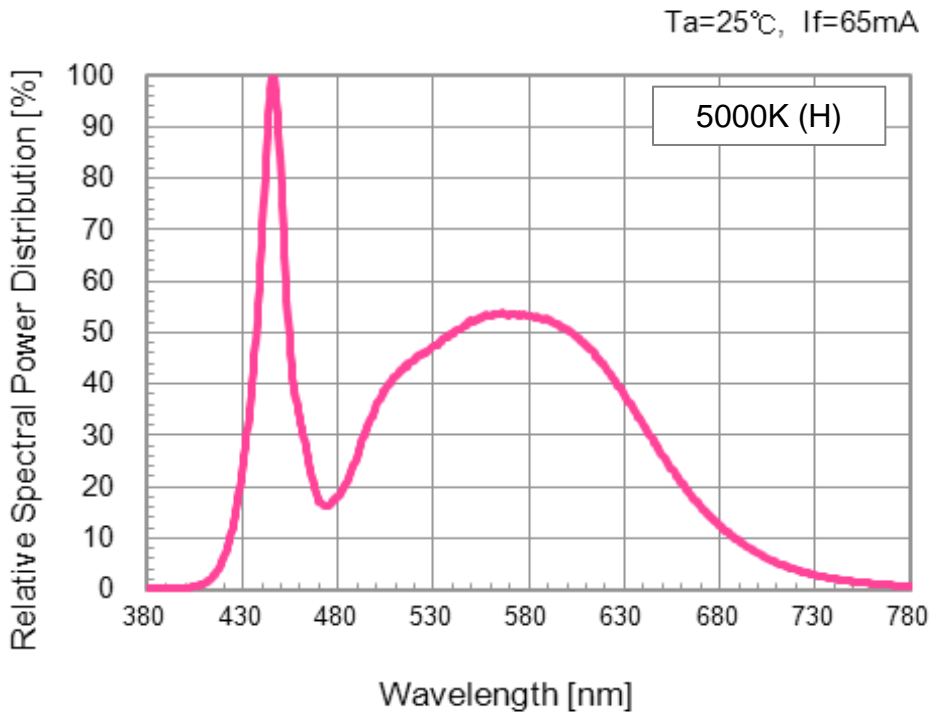

8. Typical Characteristic Curves

- Spectrum

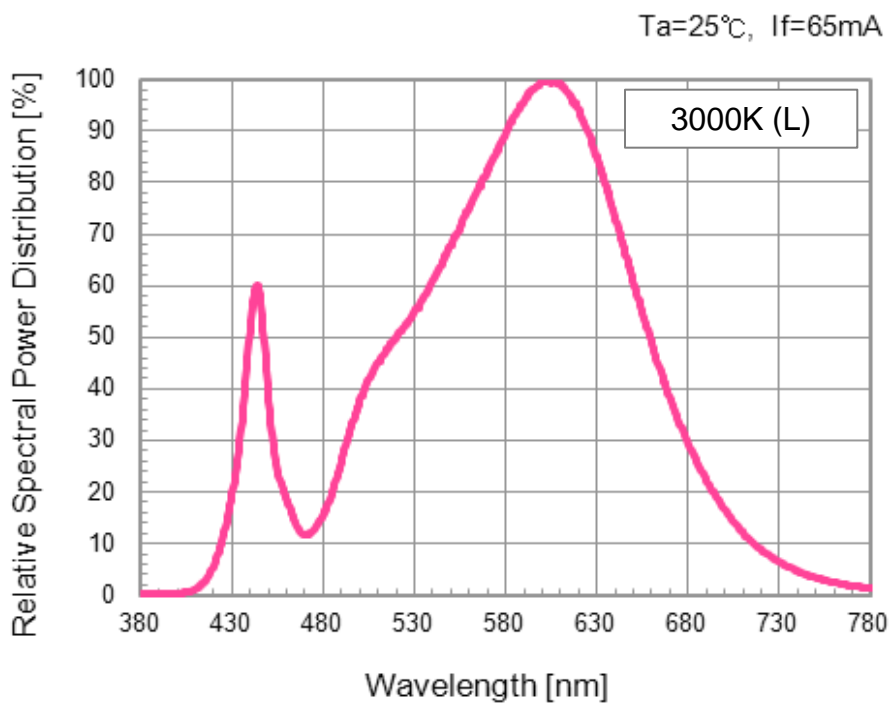
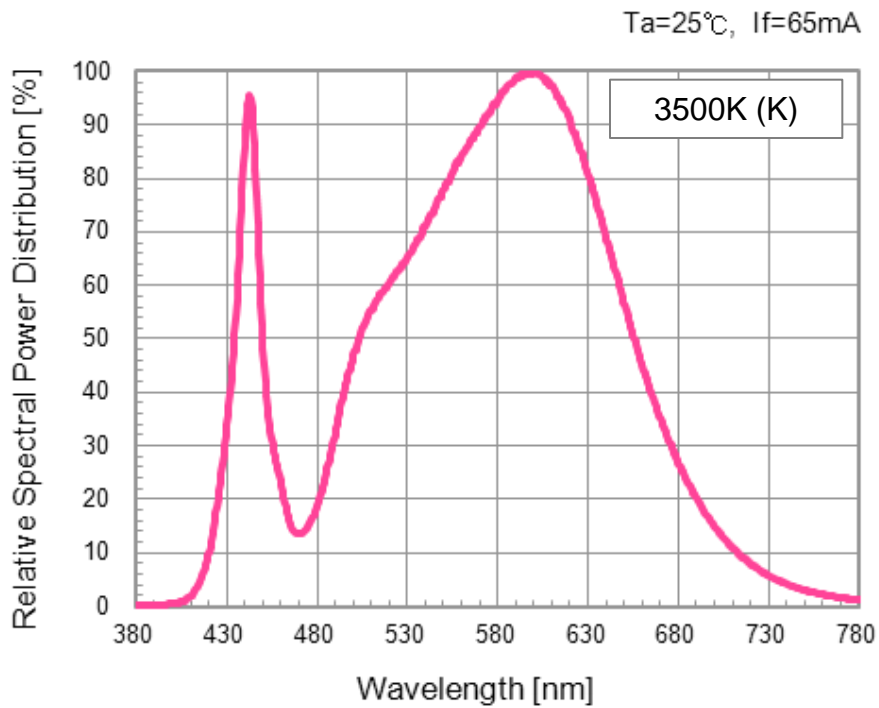

8. Typical Characteristic Curves

- Spectrum

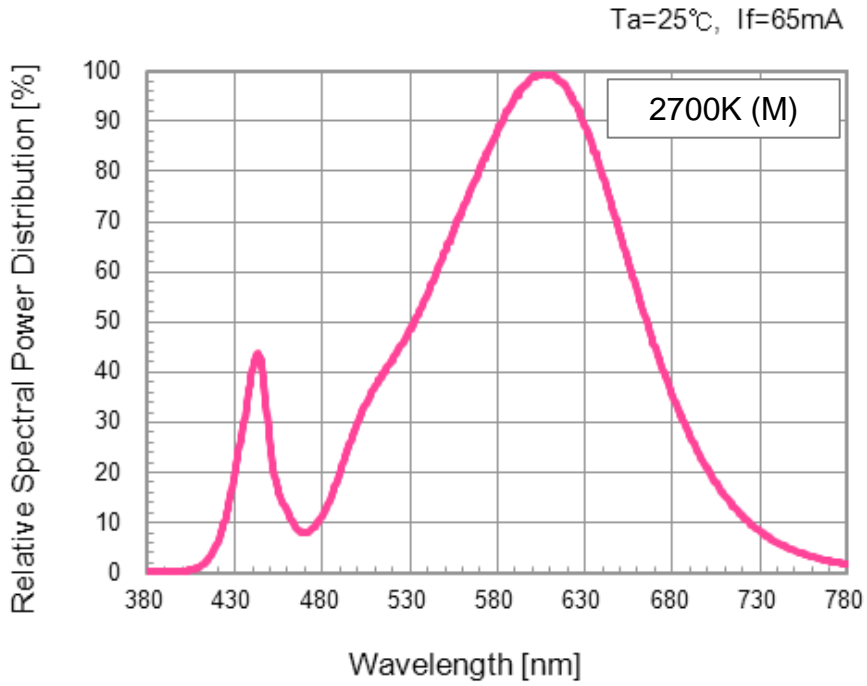

8. Typical Characteristic Curves

- Chromaticity Coordinate vs. Forward Current

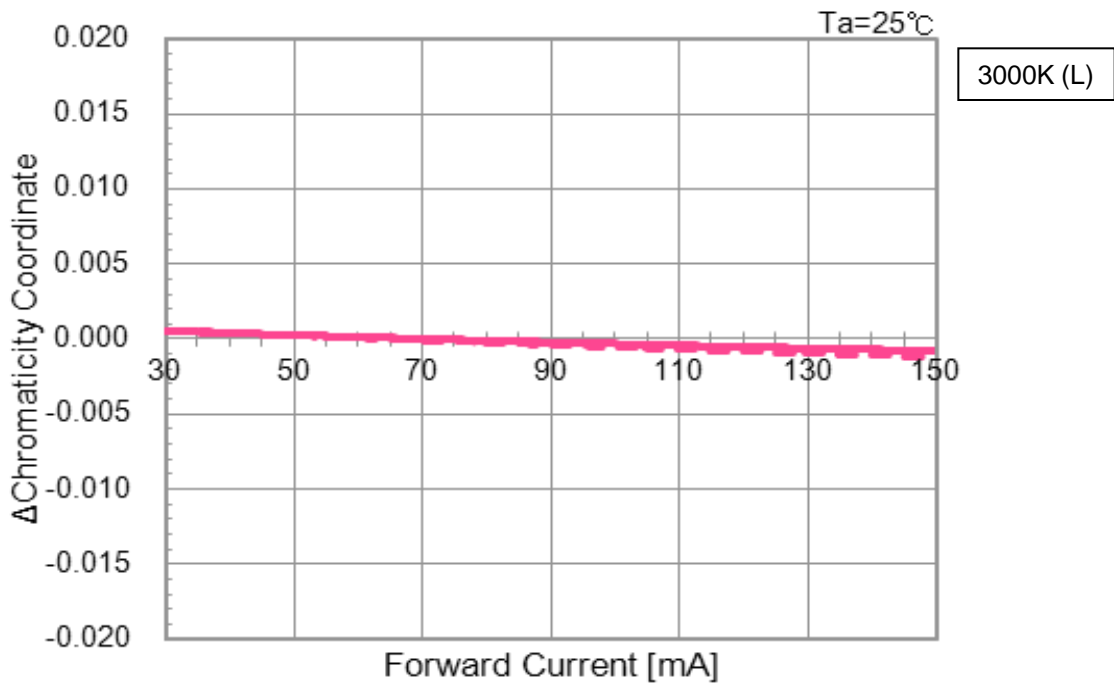
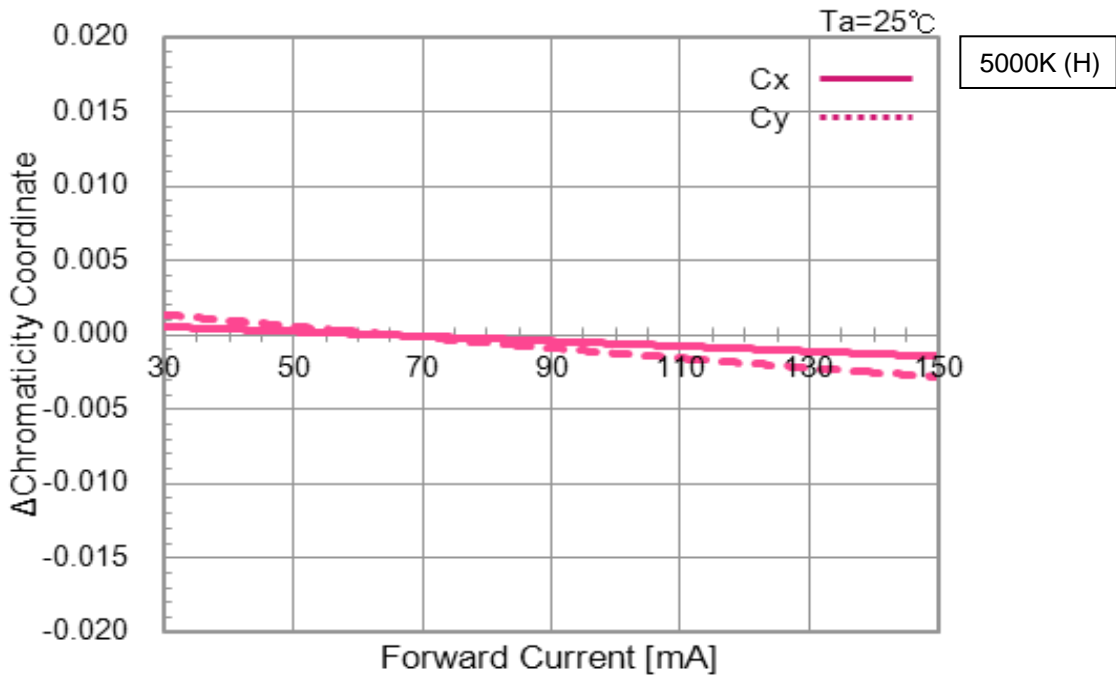

※ 5000K CCT data also applies to 5700K and 6500K CCTs and 3000K data also applies to 2700K, 3500K and 4000K CCTs.

8. Typical Characteristic Curves

- Radiation Characteristics

Ta 25°C, If = 65mA

Ta 25°C, If = 65mA

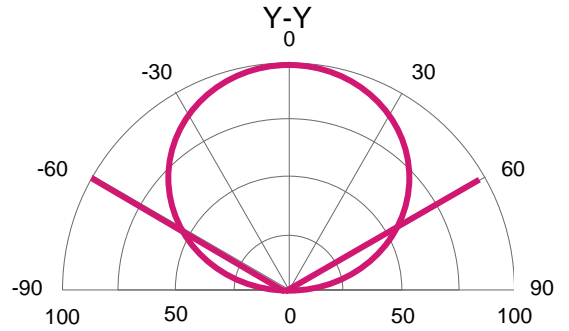
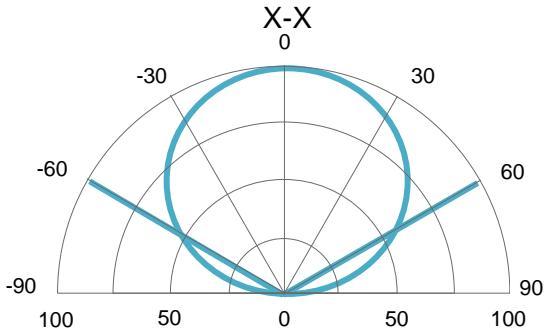

- Luminous Flux vs. Temperature

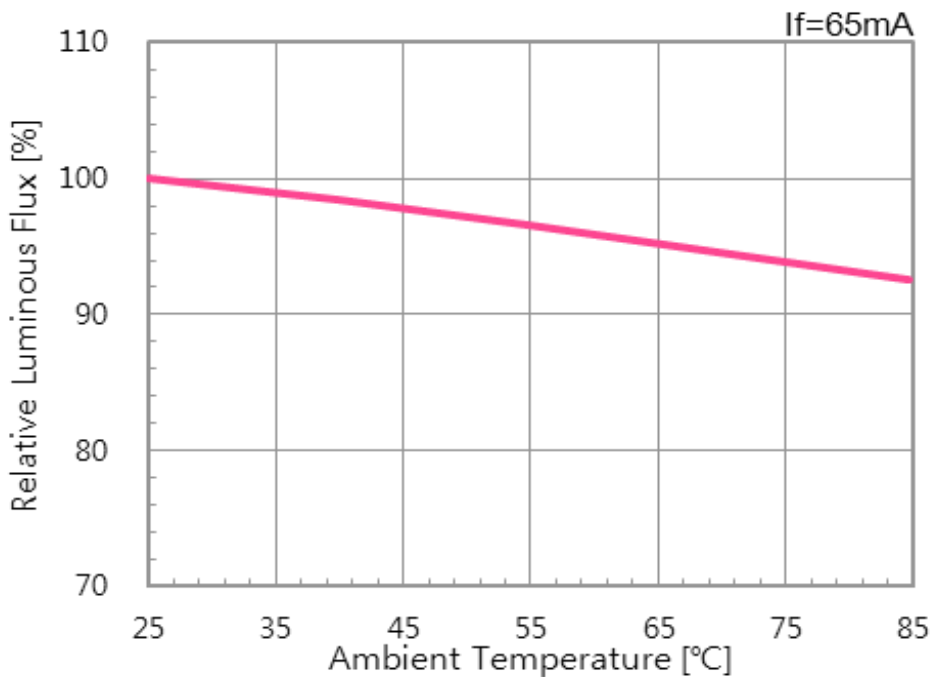

8. Typical Characteristic Curves

- Chromaticity Coordinate vs. Temperature

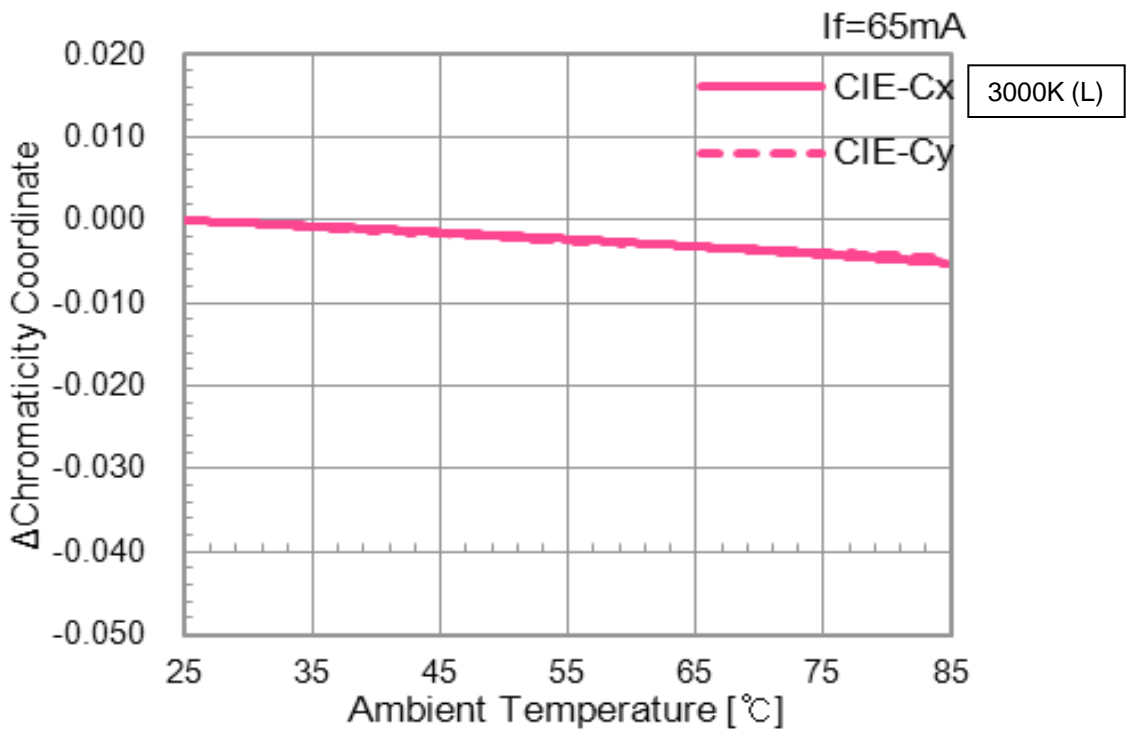
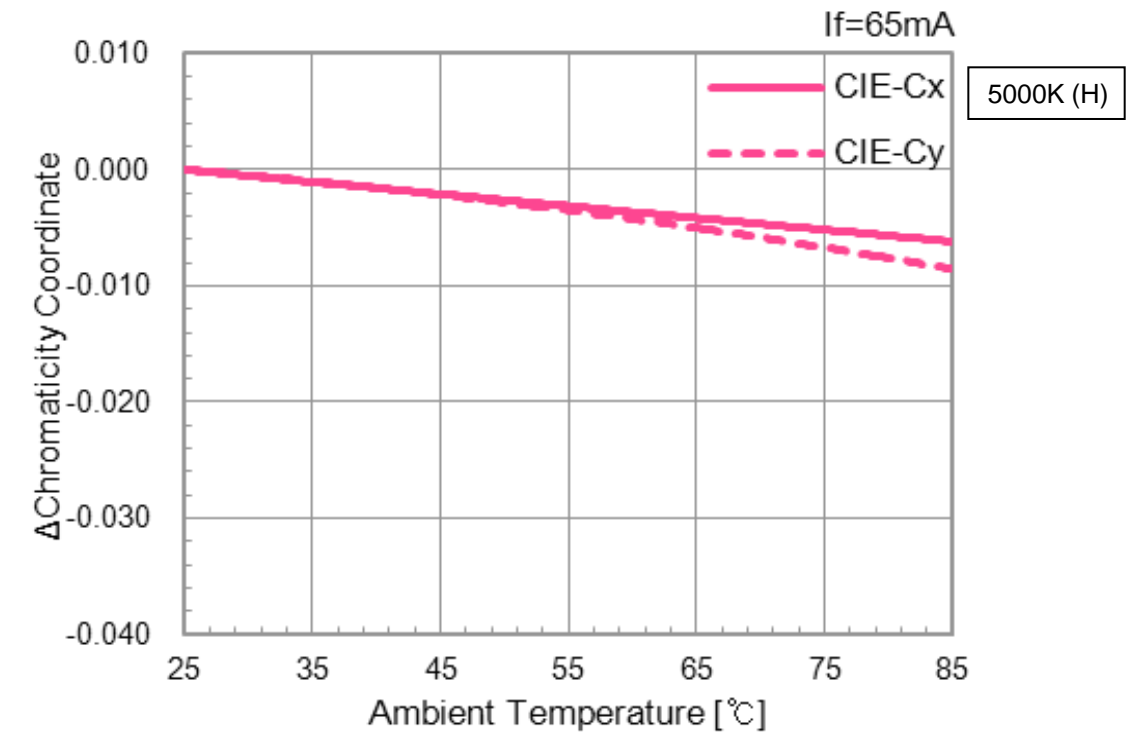

※ 5000K CCT data also applies to 5700K and 6500K CCTs and 3000K data also applies to 2700K, 3500K and 4000K CCTs.

8. Typical Characteristic Curves

- Forward Voltage vs. Temperature

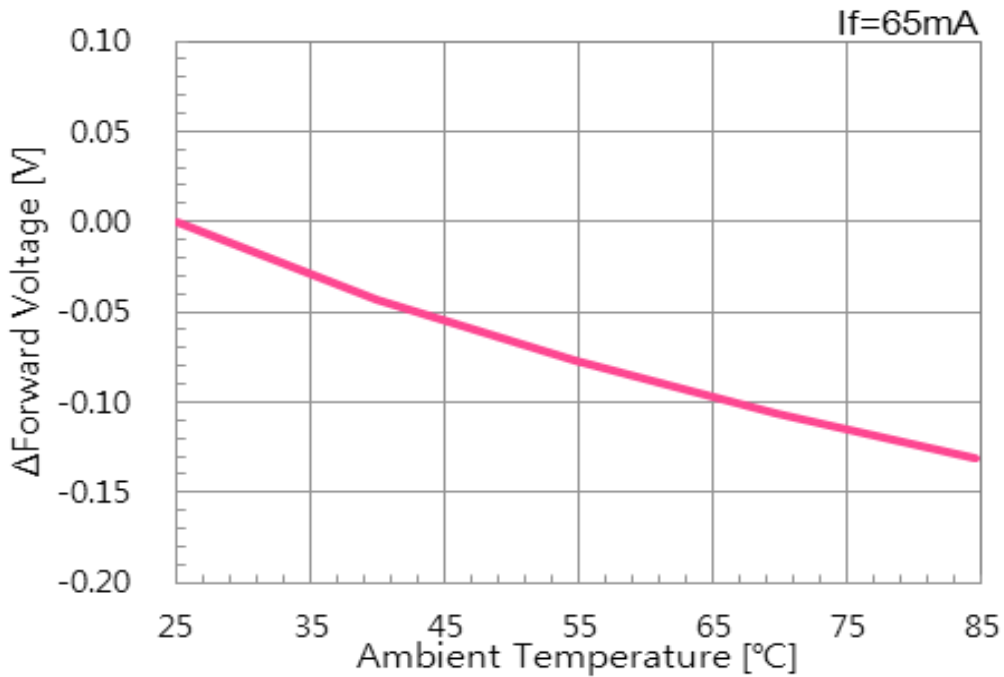

- Derating Curve

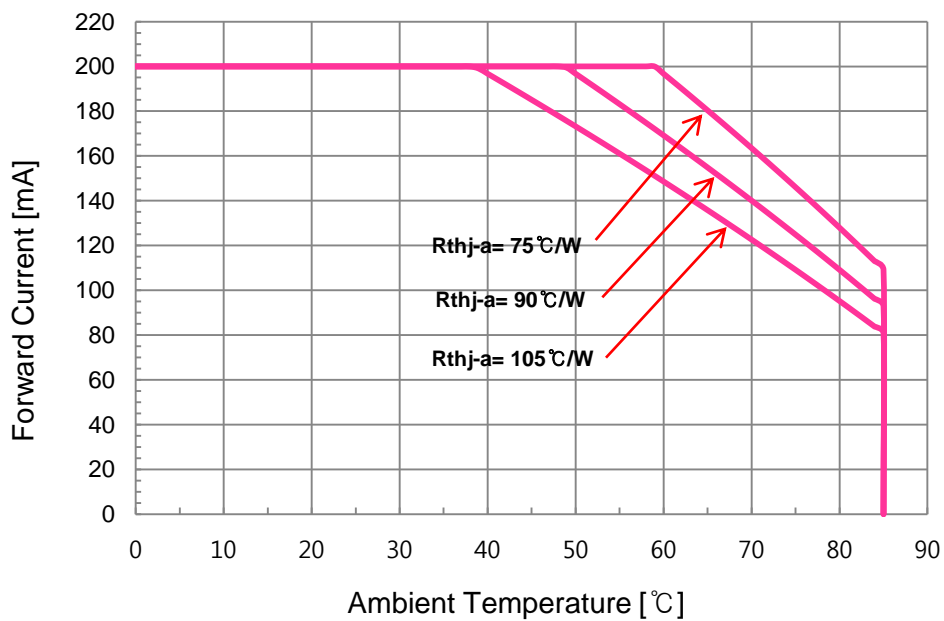

※ The ambient temperature values for each graph are obtained with LG Innotek equipment.

9. Reliability Test Items and Conditions

9-1. Failure Criteria

Items	Symbols	Test Conditions	Criteria	
			Min.	Max.
Forward Voltage	V _f	I _f = 65mA	-	Initial Value × 1.1
Luminous Flux	Φ _v	I _f = 65mA	Initial Value × 0.7	-

9-2. Reliability Tests

No	Items	Test Conditions	Test Hours /Cycles
1	Room Temperature Operating Life (RTOL)	T _a = 25 °C, I _f = 200mA	1,000 Hours
2	Wet High Temperature Operating Life (WHTOL)	T _a = 60 °C, RH = 90%, I _f = 200mA	1,000 Hours
3	High Temperature Operating Life (HTOL)	T _a = 85 °C, I _f = 200mA	1,000 Hours
4	Low Temperature Operating Life (LTOL)	T _a = -40 °C, I _f = 200mA	1,000 Hours
5	High Temperature Storage Life (HTSL)	T _a = 100 °C	1,000 Hours
6	Low Temperature Storage Life (LTSL)	T _a = -40 °C	1,000 Hours
7	Wet High Temperature Storage Life (WHTSL)	T _a = 85 °C, RH = 85%	1,000 Hours
8	Thermal Shock (TMSK)	100 °C ~ -40 °C Dwell : 15 min., Transfer : 10 sec.	100 Cycles
9	Moisture Sensitivity Level (MSL)	T _{sld} = 260 °C (Pre treatment 60 °C, 60%, 168 hours)	3 Times

※ All samples are tested using LG Innotek Standard Metal PCB (25x25x1.6 mm³(L×W×H)) except MSL test .

※ All samples must pass each test item and all test items must be satisfied.

10. Packing and Labeling of Product

10-1. Taping Outline Dimensions

Reel

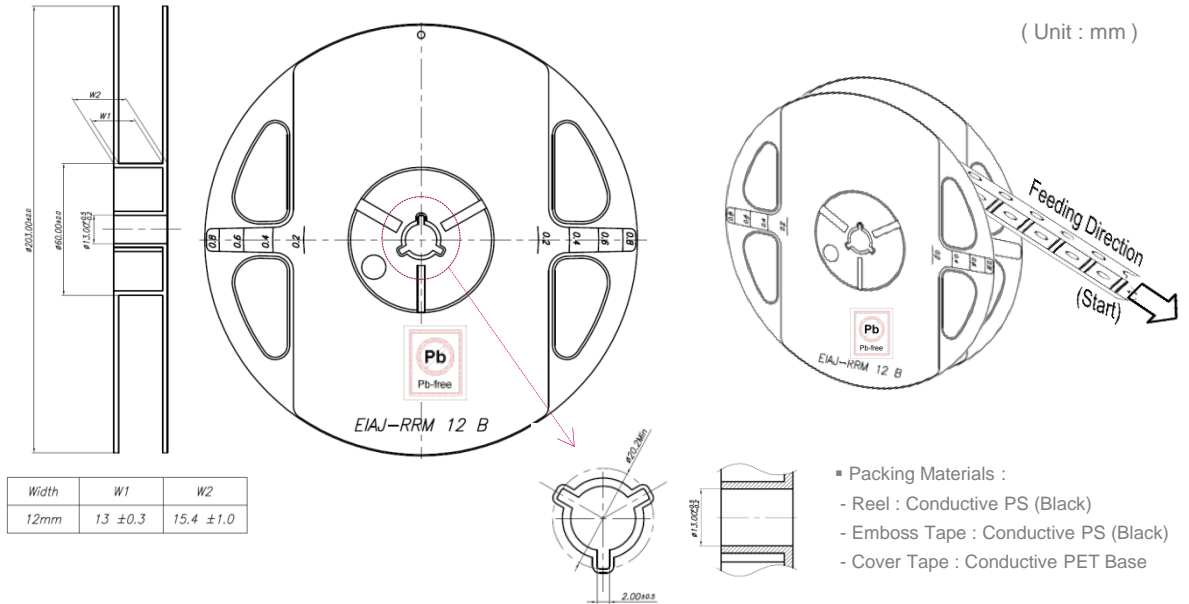

Tape

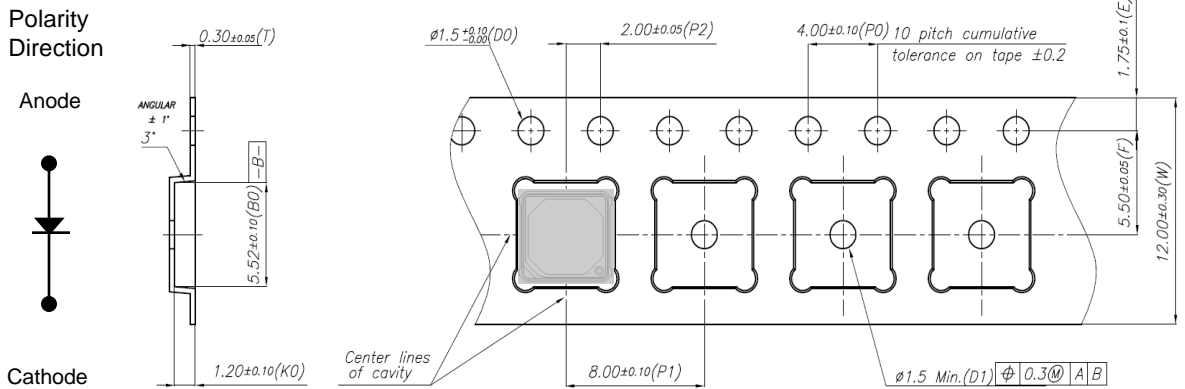

Taping Arrangement



10. Packing and Labeling of Product

10-2. Packing Structures

Reeled products are packed in a sealed-off and moisture-proof aluminum bag with desiccants (silica gel) and Humidity Indicator Card(HIC). A maximum of four aluminum bags are packed in an inner box and six inner boxes are packed in an outer box.

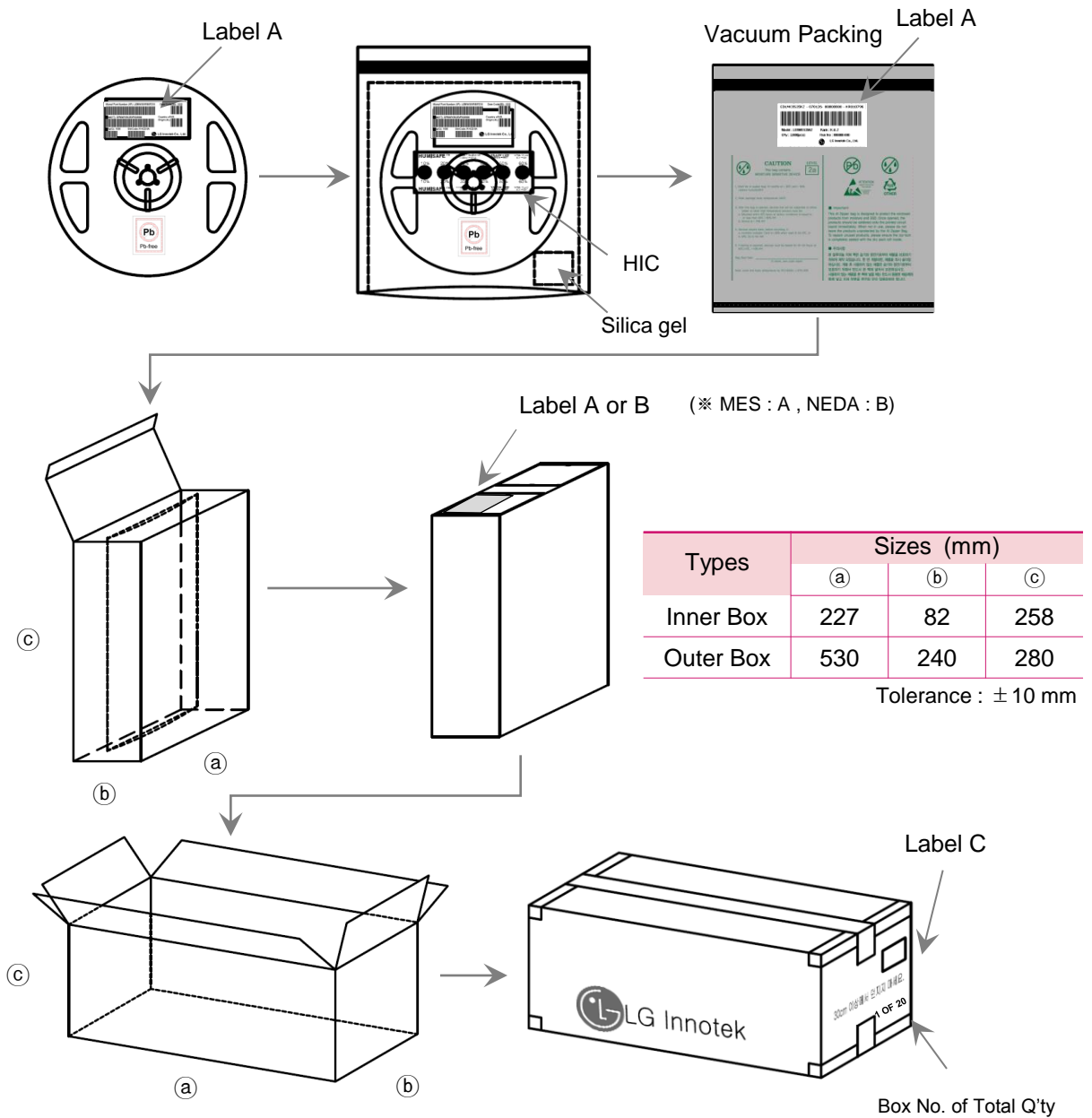

10. Packing and Labeling of Product

10-3. MES Label Structure

※. Label A

Specifying Model Name, Rank, Rack, Quantity and Run number

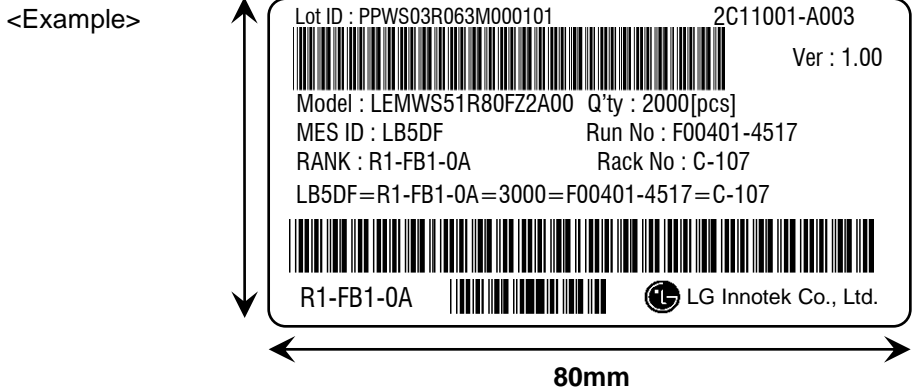

▪ Run No. indication

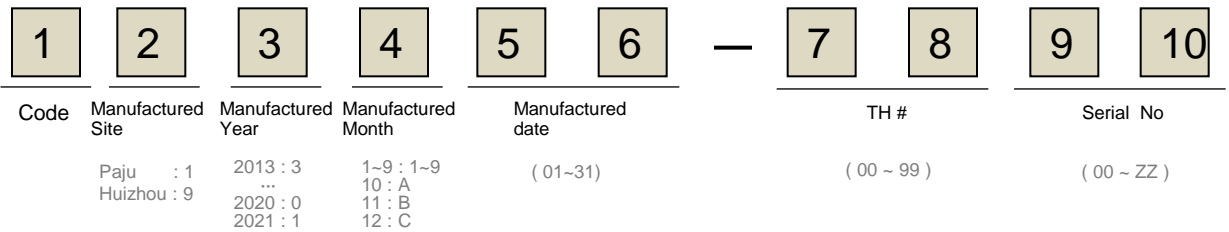

※. Label C

Specifying Customer, Date, Model Name, Quantity, Customer Part no, Outbox ID, Rank/Rank Q'ty

<Example>



▪ Box ID. indication

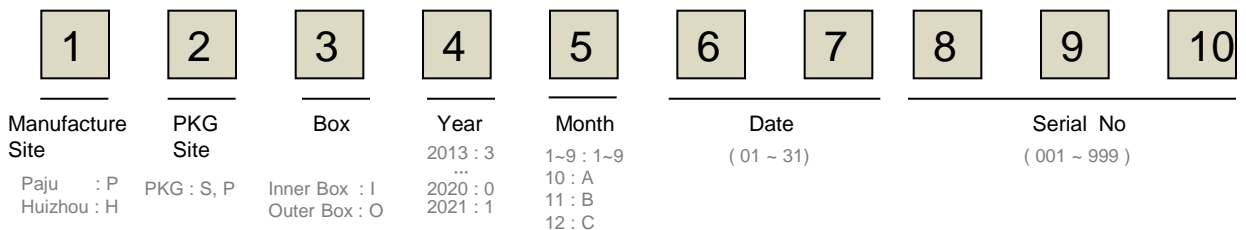

10. Packing and Labeling of Product

10-4. NEDA Label Structure

※ Label A

Specifying 'Manufacturing Part Number', 'Quantity', 'Bin Code', 'Lot', 'Date Code' and 'Country of Origin'

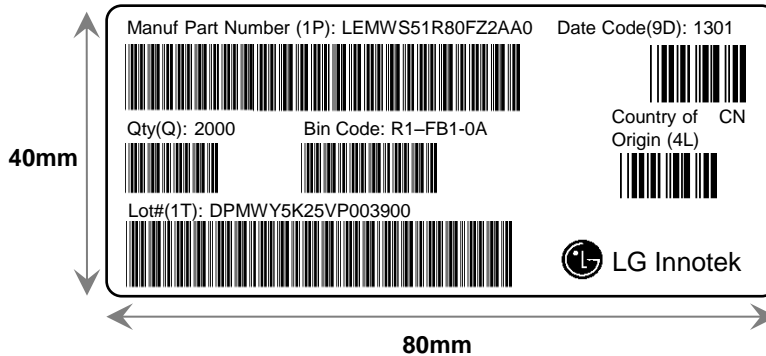

▪ Date Code(9D)

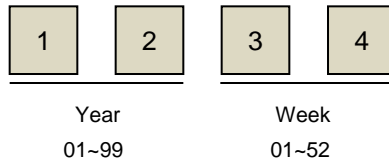

▪ Lot#(1T)

LG Innotek Trace Code

▪ Bin Code

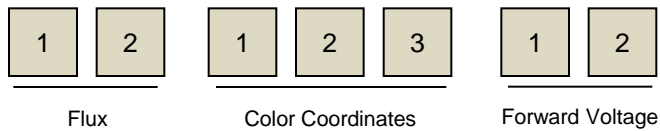

※ Label B

Specifying 'Manufacturing Part Number', 'Quantity', 'Bin Code', 'Trans ID', 'Date Code', 'Country of Origin' and 'Inner Box ID'

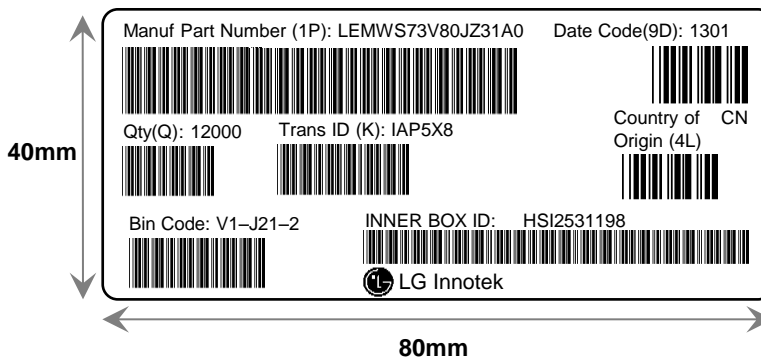

10. Packing and Labeling of Product

10-4. NEDA Label Structure

※ Label C

Specifying 'Manufacturing Site', 'Customer Address', 'Manufacturing Part Number', 'Bin Code', 'Box ID', 'Trans ID' and 'Quantity'



▪ Box ID indication

1	2	3	4	5	6	7	8	9	10
Site	Code	Outbox	Year	Month	Date		Serial No		
Paju: P Huizhou: H	S, P	Outbox: O Inbox: I	13 : 3 14 : 4 15 : 5	1~9 : 1~9 10 : A 11 : B 12 : C	(01 ~ 31)		(001 ~ 999)		

11. Cautions on Use

11-1. Moisture-Proof Package

- The moisture in the SMD package may vaporize and expand during soldering.
- The moisture can damage the optical characteristics of the LEDs due to the encapsulation.

11-2. During Storage

Conditions		Temperature	Humidity	Time
Storage	Before Opening Aluminum Bag	5°C ~ 30°C	< 50%RH	Within 1 Year from the Delivery Date
	After Opening Aluminum Bag	5°C ~ 30°C	< 60%RH	≤ 672 hours
Baking		65 ± 5°C	< 10%RH	10 ~ 24 hours

11-3. During Usage

- The LED should avoid direct contact with hazardous materials such as sulfur, chlorine, phthalate, etc.
- The metal parts on the LED can rust when exposed to corrosive gases. Therefore, exposure to corrosive gases must be avoided during operation and storage.
- The silver-plated metal parts also can be affected, not only by the corrosive gases emitted inside of the end-products but by the gases penetrated from the outside environment.
- Extreme environments such as sudden ambient temperature changes or high humidity that can cause condensation must be avoided.

11-4. Cleaning

- Do not use brushes for cleaning or organic solvents (i.e. Acetone, TCE, etc..) for washing as they may damage the resin of the LEDs.
- Isopropyl Alcohol(IPA) is the recommended solvent for cleaning the LEDs under the following conditions.
Cleaning Condition : IPA, 25°C max. × 60sec max.
- Ultrasonic cleaning is not recommended.
- Pretests should be conducted with the actual cleaning process to validate that the process will not damage the LEDs.

11. Cautions on Use

11-5. Thermal Management

- The thermal design of the end product must be seriously considered, particularly at the beginning of the system design process.
- The generation of heat is greatly impacted by the input power, the thermal resistance of the circuit boards and the density of the LED array combined with other components.

11-6. Static Electricity

- Wristbands and anti-electrostatic gloves are strongly recommended and all devices, equipment and machinery must be properly grounded when handling the LEDs, which are sensitive against static electricity and surge.
- Precautions are to be taken against surge voltage to the equipment that mounts the LEDs.
- Unusual characteristics such as significant increase of current leakage, decrease of turn-on voltage, or non-operation at a low current can occur when the LED is damaged.

11-7. Recommended Circuit

- The current through each LED must not exceed the absolute maximum rating when designing the circuits.
- In general, there can be various forward voltages for LEDs. Different forward voltages in parallel via a single resistor can result in different forward currents to each LED, which also can output different luminous flux values. In the worst case, the currents can exceed the absolute maximum ratings which can stress the LEDs. Matrix circuit with a single resistor for each LED is recommended to avoid the luminous flux fluctuations.

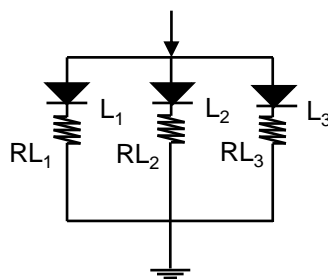

Fig.1 Recommended Circuit in Parallel Mode
: Separate resistors must be used for each LED.

- The driving circuits must be designed to operate the LEDs by forward bias only.
- Reverse voltages can damage the zener diode, which can cause the LED to fail.
- A constant current LED driver is recommended to power the LEDs.

11. Cautions on Use

11-8. Soldering Conditions

- Reflow soldering is the recommended method for assembling LEDs on a circuit board.
- LG Innotek does not guarantee the performance of the LEDs assembled by the dip soldering method.
- Recommended Soldering Profile (according to JEDEC J-STD-020D)

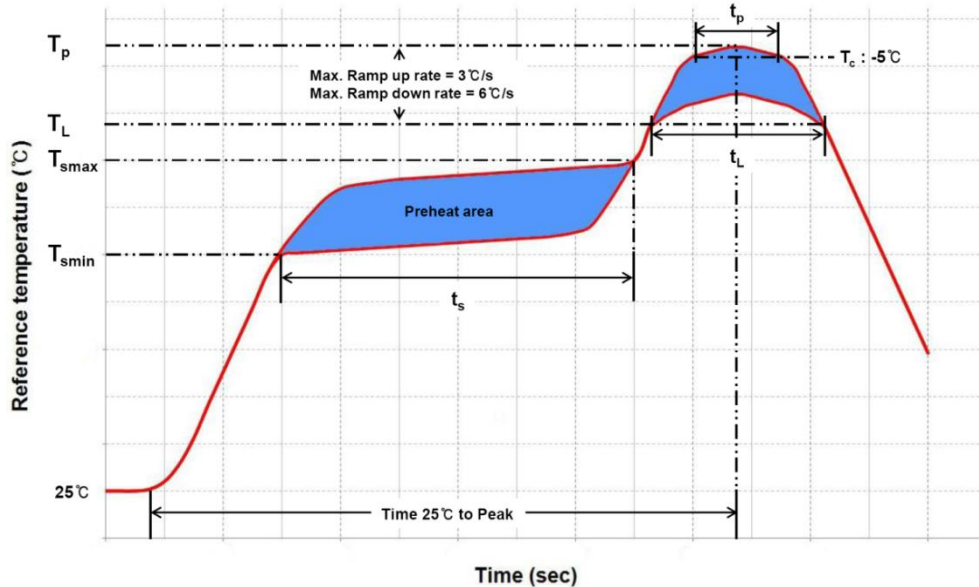

Profile Feature	Pb-Free Assembly	Pb-Based Assembly
Preheat / Soak		
Temperature Min (T_{smin})	150°C	100°C
Temperature Max (T_{smax})	200°C	150°C
Maximum time (t_s) from T_{smin} to T_{smax}	60~120 seconds	60~120 seconds
Ramp-up rate (T_L to T_p)	3°C/ second max.	3°C/ second max.
Liquidous temperature (T_L)	217°C	183°C
Time (t_L) maintained above T_L	60~150 seconds	60~150 seconds
Maximum peak package body temperature (T_p)	260°C	235°C
Time (t_p) within 5°C of the specified temperature (T_c)	30 seconds	20 seconds
Ramp-down rate (T_p to T_L)	6°C/second max.	6°C/second max.
Maximum Time 25°C to peak temperature	8 minutes max.	6 minutes max.

- Reflow or hand soldering at the lowest possible temperature is desirable for the LEDs although the recommended soldering conditions are specified in the above diagrams.
- A rapid cooling process is not recommended for the LEDs from the peak temperature.
- The silicone encapsulant at the top of the LED package is a soft surface, which can easily be damaged by pressure. Precautions should be taken to avoid strong pressure on the silicone resin when leveraging the pick and place machines.
- Reflow soldering should not be done more than two times.

11. Cautions on Use

11-9. Soldering Iron

- The recommended condition is less than 5 seconds at 260 °C.
- The time must be shorter for higher temperatures. (+10 °C → -1sec).
- The power dissipation of the soldering iron should be lower than 15W and the surface temperature of the device should be controlled at or under 230 °C.

11-10. Eye Safety Guidelines

- Do not directly look at the light when the LEDs are on.
- Proceed with caution to avoid the risk of damage to the eyes when examining the LEDs with optical instruments.

11-11. Manual Handling

- Use Teflon-type tweezers to grab the base of the LED and do not apply mechanical pressure on the surface of the encapsulant.

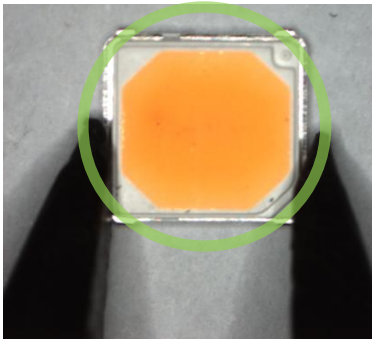

12. Disclaimers

- LG Innotek is not responsible for any damages or accidents caused if the operating or storage conditions exceed the absolute maximum ratings recommended in this document.
- The LEDs described in this document are intended to be operated by ordinary electronic equipment.
- It is recommended to consult with LG Innotek when the environment or the LED operation is non-standard in order to avoid any possible malfunctions or damage to product or risk of life or health.
- Disassembly of the LED products for the purpose of reverse engineering is prohibited without prior written consent from LG Innotek. All defected LEDs must be reported to LG Innotek and are not to be disassembled or analyzed.
- The product information can be modified and upgraded without prior notice.

Appendix. Product Nomenclature

All LEDs are tested and sorted by color, luminous flux and forward voltage where every LED in a tube has only a single color bin, luminous flux bin and forward voltage bin. However, the forward voltage bin information is not captured in the part number nomenclature.

A 16-digit part number is consisted as below; LG Innotek leverages the following part number nomenclature.

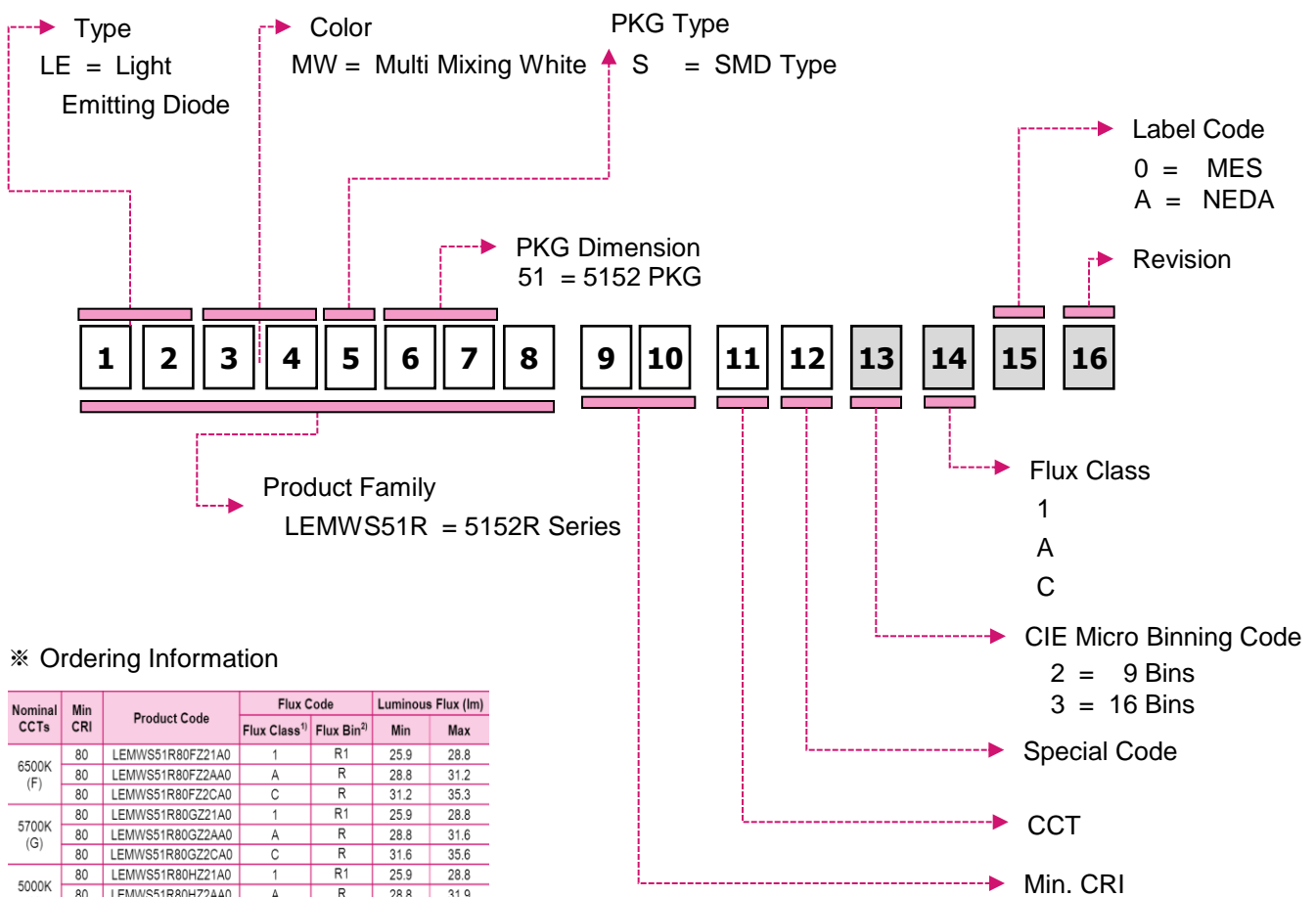

※ Ordering Information

Nominal CCTs	Min CRI	Product Code	Flux Code		Luminous Flux (lm)	
			Flux Class ¹⁾	Flux Bin ²⁾	Min	Max
6500K (F)	80	LEMWS51R80FZ21A0	1	R1	25.9	28.8
	80	LEMWS51R80FZ2AA0	A	R	28.8	31.2
	80	LEMWS51R80FZ2CA0	C	R	31.2	35.3
5700K (G)	80	LEMWS51R80GZ21A0	1	R1	25.9	28.8
	80	LEMWS51R80GZ2AA0	A	R	28.8	31.6
	80	LEMWS51R80GZ2CA0	C	R	31.6	35.6
5000K (H)	80	LEMWS51R80HZ21A0	1	R1	25.9	28.8
	80	LEMWS51R80HZ2AA0	A	R	28.8	31.9
	80	LEMWS51R80HZ2CA0	C	R	31.9	36.0
4000K (J)	80	LEMWS51R80JZ31A0	1	R1	25.0	27.8
	80	LEMWS51R80JZ3AA0	A	R	27.8	30.6
	80	LEMWS51R80JZ3CA0	C	R	30.6	34.6
3500K (K)	80	LEMWS51R80KZ31A0	1	R1	24.0	26.9
	80	LEMWS51R80KZ3AA0	A	R	26.9	30.0
	80	LEMWS51R80KZ3CA0	C	R	30.0	33.9
3000K (L)	80	LEMWS51R80LZ31A0	1	R1	24.0	26.9
	80	LEMWS51R80LZ3AA0	A	R	26.9	29.7
	80	LEMWS51R80LZ3CA0	C	R	29.7	33.5
2700K (M)	80	LEMWS51R80MZ31A0	1	R1	23.0	25.9
	80	LEMWS51R80MZ3AA0	A	R	25.9	27.3
	80	LEMWS51R80MZ3CA0	C	R	27.3	30.8

¹⁾ "Flux Class" is the 14th digit in the Product Code which is used for ordering 5152 Family LED's
²⁾ "Flux Bin" is the flux as referenced on the product label (refer to 10-4 in section 10)

Example : LEMWS51R80LZ3CA0 would be:

Product Family = LEMWS51R = 5152R Series
 CRI = 80
 CCT(Nominal) = L = 3000K
 Special Code = Z = n/a
 CIE Micro Bins = 3 = 16 ANSI Bin Structure
 Flux Class = C = min 29.7 lm ~
 Label Code = A = NEDA
 Revision = 0

