

## Data sheet

Commercial Art.No.: 25.790.0453.0

Printed circuit board terminal 8158 / 4 TOP H OB

PCB terminal with tension spring connection, 4 poles, with solder pin (3.5mm), max. cross section: 2.5 mm<sup>2</sup>, pitch: 5 mm, type of packing: carton, color: grey



Commercial Art.No.	25.790.0453.0
EAN	4015573503465
Order Unit	50

Certificates / Approvals



## Technical data

### General

Modular spacing	5 mm
Connection type	spring clamp connection
Soldering process	Wave soldering
Packaging	Carton
Number of poles	4
Conductor to circuit board	180°
Number of levels	1
Integrated test socket	yes
Insulation plate	No
Retaining pins	No
Marking	No

### Technical data

Nominal cross section	2.5 mm <sup>2</sup>
Rated current	16 A
Overvoltage Category I	1000 V
Overvoltage Category II	690 V
Overvoltage Category III	250 V
Rated impulse voltage	4 kV
Wire strip length	9 mm

### Connection Data

Minimum cross section solid	0.14 mm <sup>2</sup>
Maximum cross section solid	4 mm <sup>2</sup>
Minimum cross section fine stranded	0.14 mm <sup>2</sup>
Maximum cross section fine stranded	2.5 mm <sup>2</sup>
Wire strip length	9 mm

**Technical Data UL/CSA**

Cross section UL	30-12 AWG
Voltage UL	300 V
Current field wiring	20 A
Current factory wiring	20 A
Cross section CSA	22-12 AWG
Voltage CSA	300 V
Current CSA	20 A

**Other**

Type of insulation material	Thermoplastic
Color	Grey
Height	17.8 mm
Length	21.5 mm
Depth	15.45 mm
Material attachment screw	None
Material contact base	E-Cu
Material contact surface	Sn

**Classification**

ECLASS 11	
ECLASS 8.1	27440401
ETIM 7.0	EC002643
ETIM 6.0	EC002643
ETIM 5.0	EC002643
ETIM 4.0	EC002643

**Product compliance**

ROHS conformity status	Compliant
REACH-SVHC conformity status	Compliant

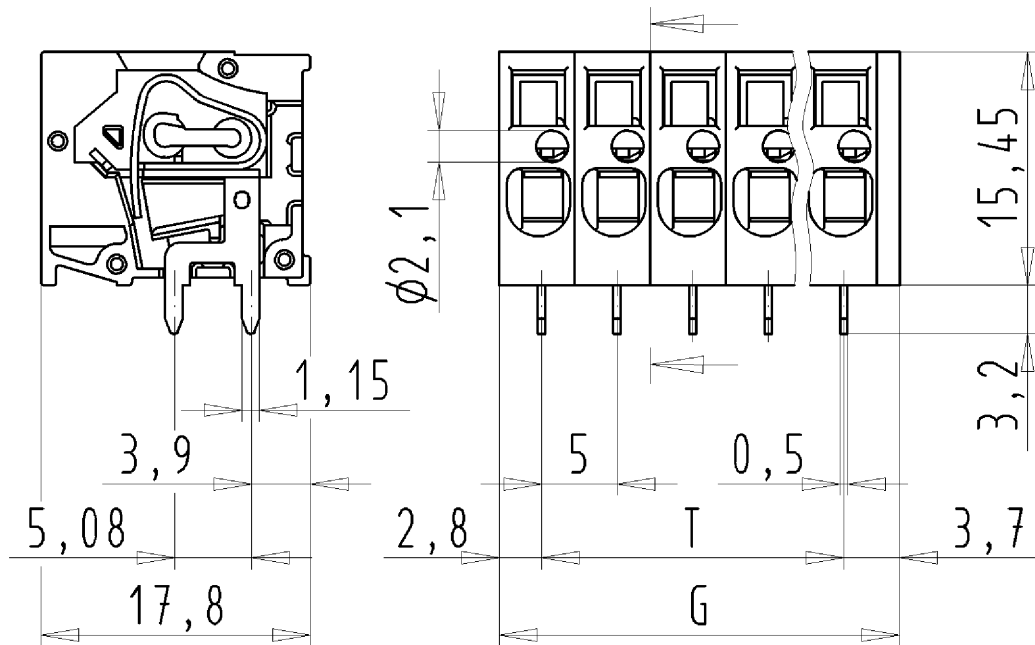

für folgende Tabellen-Zchnng.  
 25.790.2453.0 8158/... TOP H

LP.KLEMME  
 25.790.0253.0 10W  
 26.11.2007 DÜT  
 M 2:1