

X2G75SD12P1

HIGH POWER SPT+ TYPE 2-PACK IGBT MODULE



1200V
75A

PACKAGE : M1

■ CIRCUIT DIAGRAM

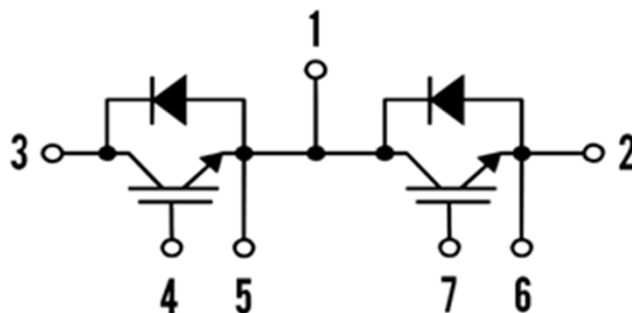

■ FEATURES

- Soft Punch Through (SPT+) Technology
- Fast & soft inverse CAL diodes
- 10us short circuit capability
- Positive $V_{CE(on)}$ temperature coefficient
- Industry standard package

■ APPLICATIONS

- High power inverter
- Switched mode power supplies (SMPS)
- UPS
- Electrical welding machine

■ ABSOLUTE MAXIMUM RATINGS

$T_c=25^\circ\text{C}$, unless otherwise specified

Symbol	Parameter	Conditions	Ratings	Unit
V_{CES}	Collector-emitter voltage	-	1200	V
I_C	DC-collector current	$T_c = 25^\circ\text{C}$	100	A
		$T_c = 80^\circ\text{C}$	75	A
I_{CRM}	Repetitive peak collector current	$T_p = 1\text{ms}$ $T_c = 80^\circ\text{C}$	150	A
V_{GES}	Gate-emitter peak voltage	-	± 20	V
I_F	Diode continuous forward current	$T_c = 80^\circ\text{C}$	75	A
I_{FRM}	Diode repetitive peak forward current	-	150	A
$T_{j,max}$	Maximum junction temperature	-	-40 ~ 150	$^\circ\text{C}$
$T_{j,op}$	Operating temperature range	-	-40 ~ 125	$^\circ\text{C}$
T_{stg}	Storage temperature range	-	-40 ~ 125	$^\circ\text{C}$
V_{ISOL}	Insulation test voltage	50/60Hz, $t=1\text{min}$ $I_{ISOL}=1\text{mA}$	2.5	kV
M_S	Mounting screw torque	M6	3.0 ~ 6.0	N.m
M_t	Mounting terminals screw torque	M5	2.5 ~ 5.0	N.m

Technical information and specification subject to change without notice.

ELECTRICAL CHARACTERISTICS OF IGBT

$T_j=25^\circ\text{C}$ unless otherwise specified

Symbol	Parameter	Min	Typ	Max	Unit	Conditions
$V_{CE(Sat)}$	C-E saturation voltage	-	1.8	-	V	$I_C = 75\text{A}, V_{GE} = 15\text{V}, T_j = 25^\circ\text{C}$
		-	2.0	-	V	$I_C = 75\text{A}, V_{GE} = 15\text{V}, T_j = 125^\circ\text{C}$
$V_{GE(th)}$	G-E threshold voltage	5.0	6.2	7.0	V	$I_C = 3\text{mA}, V_{CE} = V_{GE}$
I_{CES}	Zero gate voltage collector current	-	300	-	μA	$V_{GE} = 0\text{V}, V_{CE} = 1200\text{V}$
I_{GES}	G-E leakage current	-200	-	200	nA	$V_{GE} = \pm 20\text{V}$
R_{Gint}	Internal gate resistance	-	3.0	-	Ω	-
C_{ies}	Input capacitance	-	6.14	-	nF	$V_{GE} = 0\text{V},$ $f = 1\text{MHz},$ $V_{CE} = 25\text{V},$ $T_j = 25^\circ\text{C}$
C_{oes}	Output capacitance	-	0.64	-		
C_{res}	Reverse transfer capacitance	-	0.44	-		
Q_g	Total gate charge	-	780	-	nC	$V_{GE} = \pm 15\text{V}$
$t_{d(on)}$	Turn-on delay time	-	160	-	ns	$V_{CE} = 600\text{V},$ $I_C = 75\text{A},$ $V_{GE} = \pm 15\text{V},$ $R_G = 15\Omega,$ $T_j = 125^\circ\text{C}$
t_r	Turn-on rise time	-	65	-		
$t_{d(off)}$	Turn-off delay time	-	500	-		
t_f	Turn-off fall time	-	70	-		
E_{ON}	Turn-on Energy loss	-	10.3	-	mJ	
E_{OFF}	Turn-off Energy loss	-	7.8	-		

ELECTRICAL CHARACTERISTICS OF FRD

$T_j=25^\circ\text{C}$ unless otherwise specified

Symbol	Parameter	Min	Typ	Max	Unit	Conditions
V_F	Diode Forward Voltage Drop	-	1.6	-	V	$T_j = 25^\circ\text{C}$
		-	1.6	-		$T_j = 125^\circ\text{C}$
I_{rr}	Peak Reverse Recovery Current	-	43	-	A	$I_F = 75\text{A}, V_{CE} = 600\text{V}$
Q_{rr}	Diode Recovery Charge	-	12	-	μC	$V_{GE} = -15\text{V}, T_j = 125^\circ\text{C}$

THERMAL AND MECHANICAL CHARACTERISTICS

$T_j=25^\circ\text{C}$ unless otherwise specified

Symbol	Parameter	Min	Typ	Max	Unit	Condition
$R_{th(j-c)}$	Junction-to-Case (IGBT Part, Per 1/2 Module)	-	0.2	-	$^\circ\text{C}/\text{W}$	
$R_{th(j-c)}$	Junction-to-Case (FRD Part, Per 1/2 Module)	-	0.7	-	$^\circ\text{C}/\text{W}$	
$R_{th(c-f)}$	Case-to-Heat Sink (With Thermal Compound)	-	0.05	-	$^\circ\text{C}/\text{W}$	
Weight	Module		180		g	

Technical information and specification subject to change without notice.

PERFORMANCE CURVES (I)

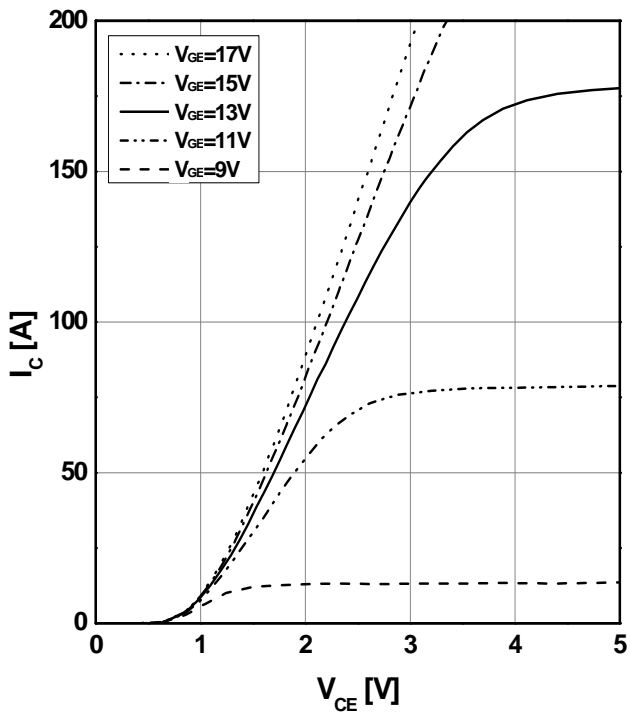

Fig1. Typical Output Characteristics

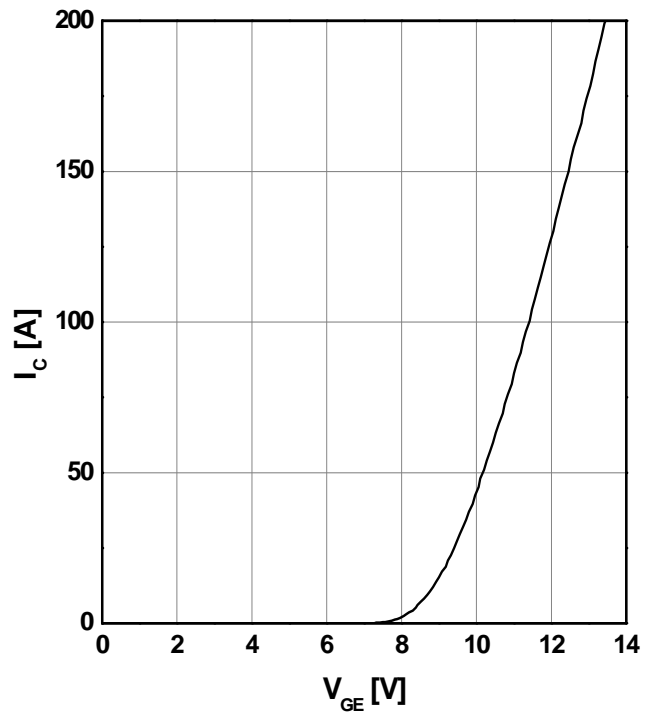

Fig2. Transfer Characteristics

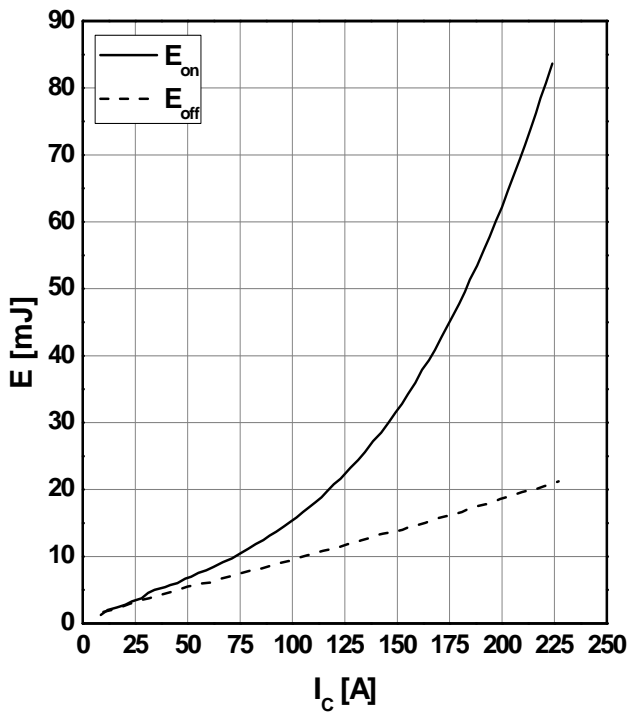

Fig3. Energy Loss vs. I_c

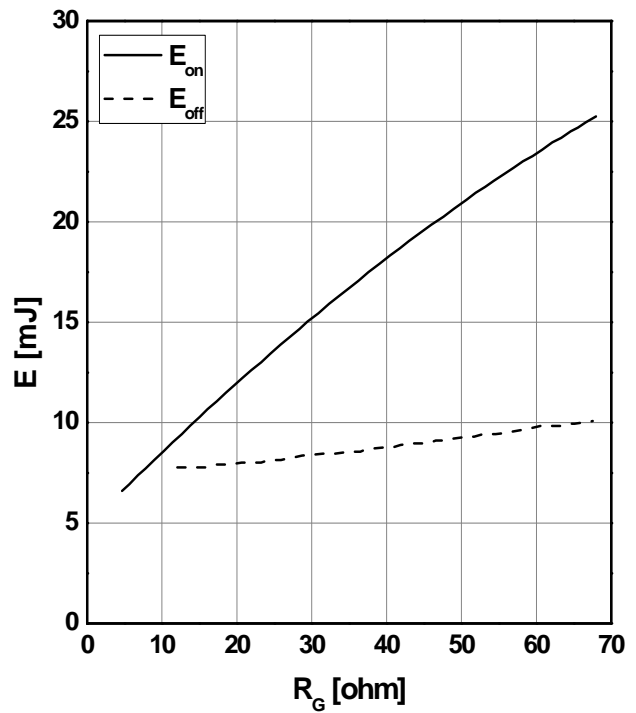

Fig4. Energy Loss vs. R_G

Technical information and specification subject to change without notice.

PERFORMANCE CURVES (II)

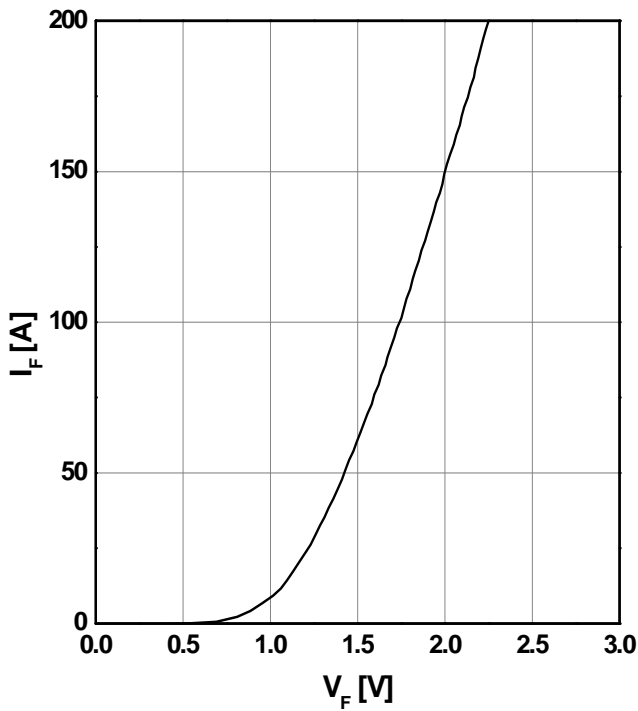

Fig5. DIODE Forward Characteristic

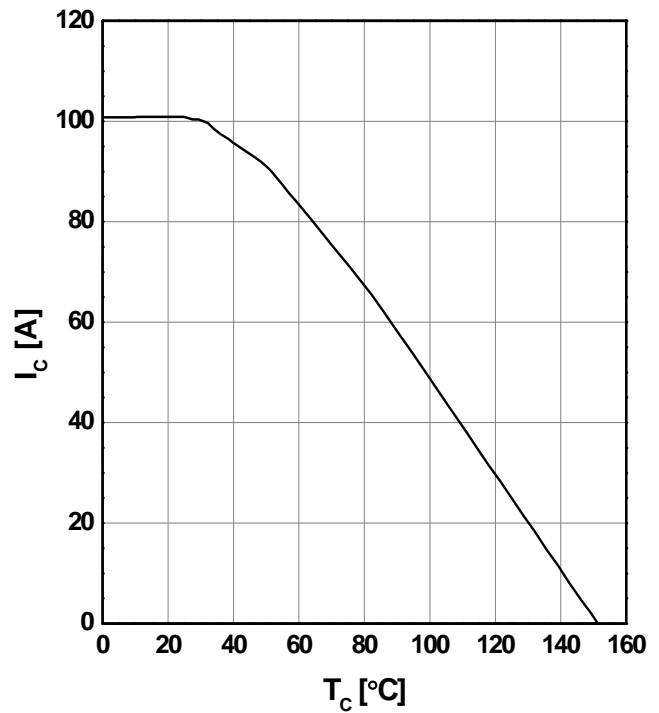

Fig6. Reverse Bias SOA ($T_j = 125^\circ\text{C}$)

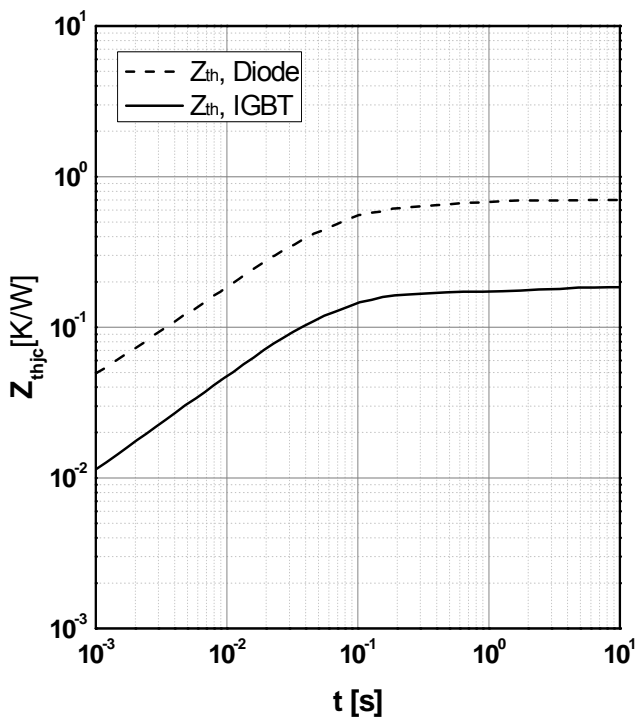

Fig7. Transient Thermal

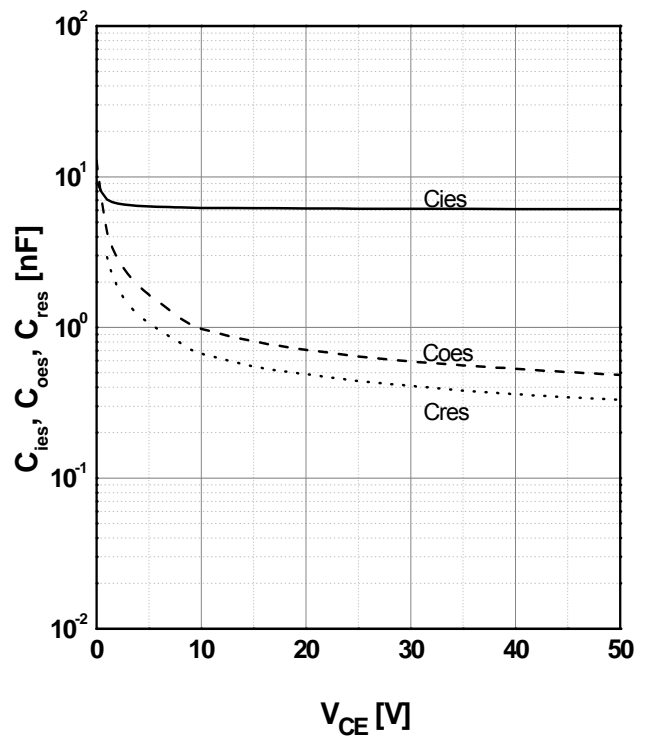

Fig8. Typ. Capacitance

Technical information and specification subject to change without notice.

X2G75SD12P1

HIGH POWER SPT+ TYPE 2-PACK IGBT MODULE

PACKAGE OUTLINES

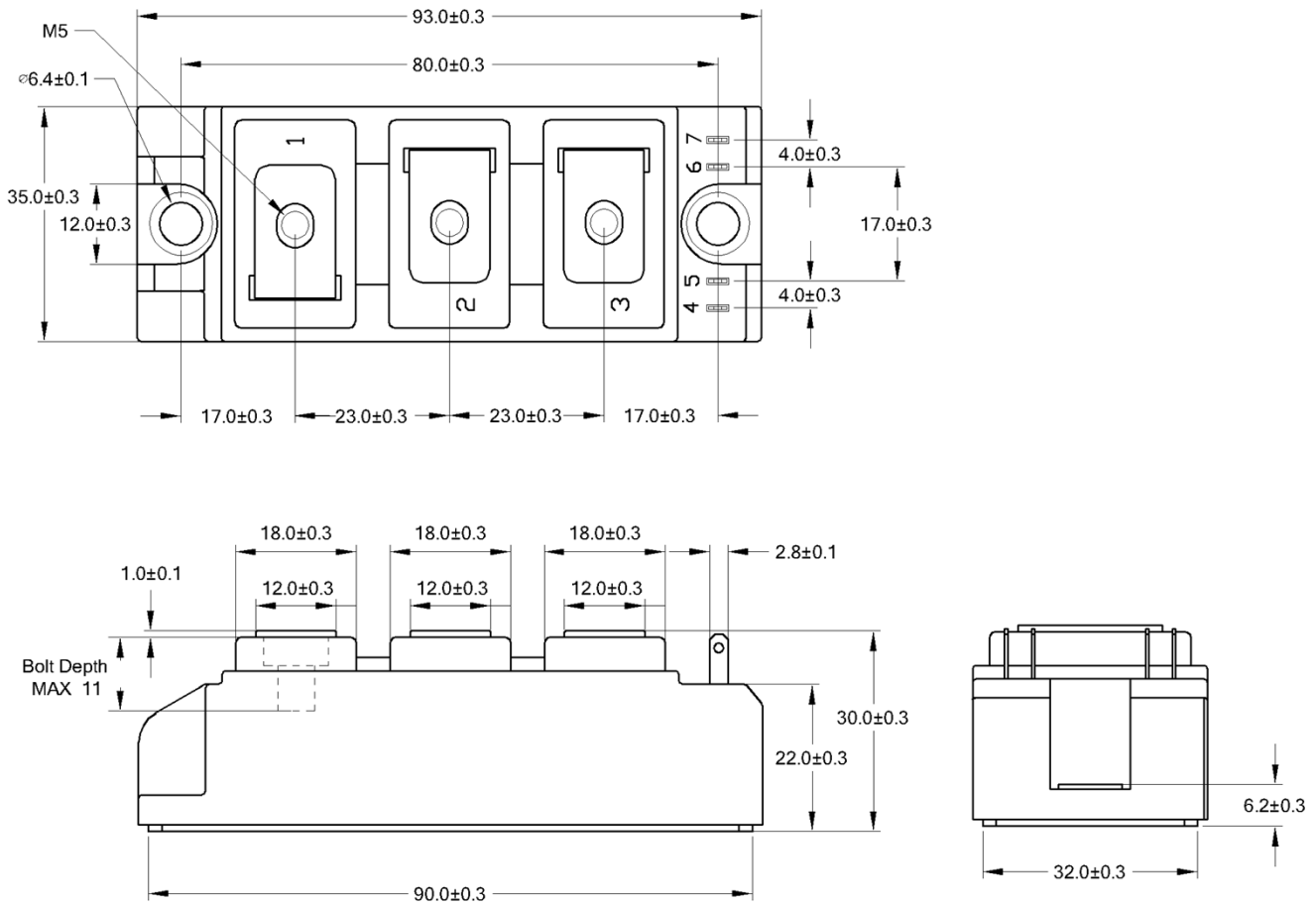

Technical information and specification subject to change without notice.