



Small Signal Fast Switching Diodes



FEATURES

- Silicon epitaxial planar diode
- Saving space
- Hermetic sealed parts
- Fits onto SOD-323 / SOT-23 footprints
- Electrical data identical with the devices 1N4148 and 1N4448 respectively
- MicroMELF package
- Material categorization: for definitions of compliance please see www.vishay.com/doc?99912



RoHS COMPLIANT HALOGEN FREE

ADDITIONAL RESOURCES



MECHANICAL DATA

Case: MicroMELF
Weight: approx. 12 mg
Cathode band color: black
Packaging codes / options:
 TR3/10K per 13" reel (8 mm tape), 10K/box
 TR/2.5K per 7" reel (8 mm tape), 12.5K/box

APPLICATIONS

- Extreme fast switches

PARTS TABLE				
PART	TYPE DIFFERENTIATION	ORDERING CODE	CIRCUIT CONFIGURATION	REMARKS
MCL4148	$V_{RRM} = 100\text{ V}$, V_F at $I_F 50\text{ mA} = 1\text{ V}$	MCL4148-TR3 or MCL4148-TR	Single	Tape and reel
MCL4448	$V_{RRM} = 100\text{ V}$, V_F at $I_F 100\text{ mA} = 1\text{ V}$	MCL4448-TR3 or MCL4448-TR	Single	Tape and reel

ABSOLUTE MAXIMUM RATINGS ($T_{amb} = 25\text{ }^\circ\text{C}$, unless otherwise specified)				
PARAMETER	TEST CONDITION	SYMBOL	VALUE	UNIT
Reverse voltage		V_R	75	V
Repetitive peak reverse voltage		V_{RRM}	100	V
Peak forward surge current	$t_p = 1\text{ }\mu\text{s}$	I_{FSM}	2	A
Repetitive peak forward current		I_{FRM}	450	mA
Forward continuous current		I_F	200	mA
Average forward current	$V_R = 0\text{ V}$	$I_{F(AV)}$	150	mA
Power dissipation		P_{tot}	500	mW

THERMAL CHARACTERISTICS ($T_{amb} = 25\text{ }^\circ\text{C}$, unless otherwise specified)				
PARAMETER	TEST CONDITION	SYMBOL	VALUE	UNIT
Thermal resistance junction to ambient air	Mounted on epoxy-glass hard tissue, Fig. 5, 35 μm copper clad, 0.9 mm ² copper area per electrode	R_{thJA}	500	K/W
Junction temperature		T_j	175	$^\circ\text{C}$
Storage temperature range		T_{stg}	-65 to +175	$^\circ\text{C}$



ELECTRICAL CHARACTERISTICS ($T_{amb} = 25\text{ }^{\circ}\text{C}$, unless otherwise specified)							
PARAMETER	TEST CONDITION	SYMBOL	SYMBOL	MIN.	TYP.	MAX.	UNIT
Forward voltage	$I_F = 5\text{ mA}$	MCL4448	V_F	0.620		0.720	V
	$I_F = 50\text{ mA}$	MCL4148	V_F		0.860	1	V
	$I_F = 100\text{ mA}$	MCL4448	V_F		0.930	1	V
Reverse current	$V_R = 20\text{ V}$		I_R			25	nA
	$V_R = 20\text{ V}, T_J = 150\text{ }^{\circ}\text{C}$		I_R			50	μA
	$V_R = 75\text{ V}$		I_R			5	μA
Breakdown voltage	$I_R = 100\text{ }\mu\text{A}, t_p/T = 0.01,$ $t_p = 0.3\text{ ms}$		$V_{(BR)}$	100			V
Diode capacitance	$V_R = 0\text{ V}, f = 1\text{ MHz},$ $V_{HF} = 50\text{ mV}$		C_D			4	pF
Rectification efficiency	$V_{HF} = 2\text{ V}, f = 100\text{ MHz}$		η_r	45			%
Reverse recovery time	$I_F = I_R = 10\text{ mA},$ $i_R = 1\text{ mA}$		t_{rr}			8	ns
	$I_F = 10\text{ mA}, V_R = 6\text{ V},$ $i_R = 0.1 \times I_R, R_L = 100\text{ }\Omega$		t_{rr}			4	

TYPICAL CHARACTERISTICS ($T_{amb} = 25\text{ }^{\circ}\text{C}$, unless otherwise specified)

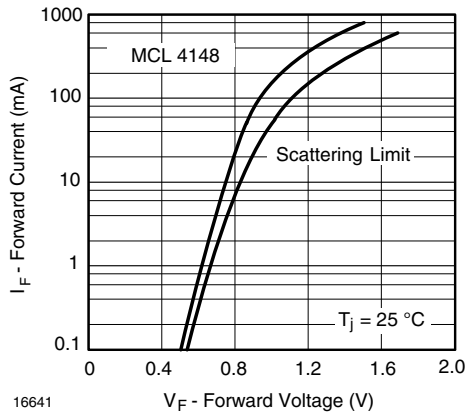

Fig. 1 - Reverse Current vs. Junction Temperature

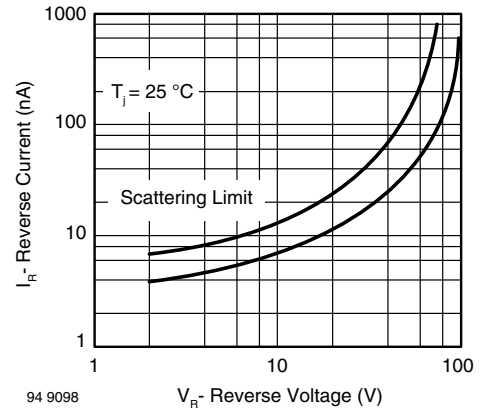

Fig. 3 - Reverse Current vs. Reverse Voltage

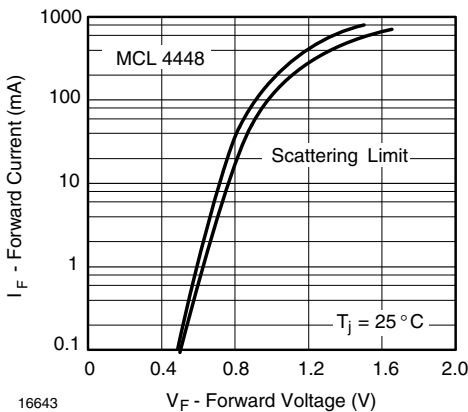

Fig. 2 - Forward Current vs. Forward Voltage

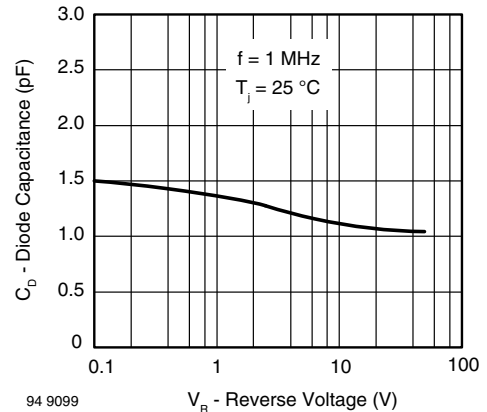

Fig. 4 - Diode Capacitance vs. Reverse Voltage

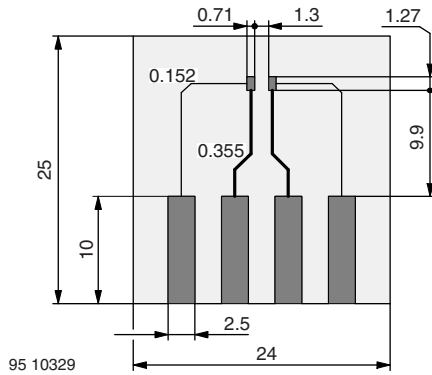
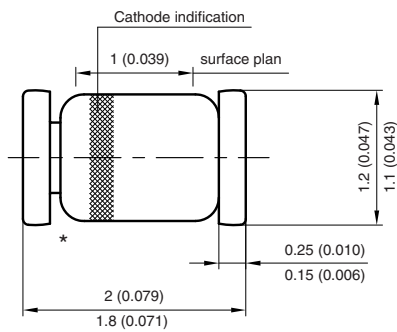
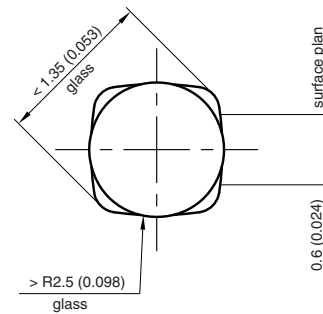

Fig. 5 - Board for R_{thJA} definition (in mm)

PACKAGE DIMENSIONS in millimeters (inches): **MicroMELF**



* The gap between plug and glass can be either on cathode or anode side



Foot print recommendation:

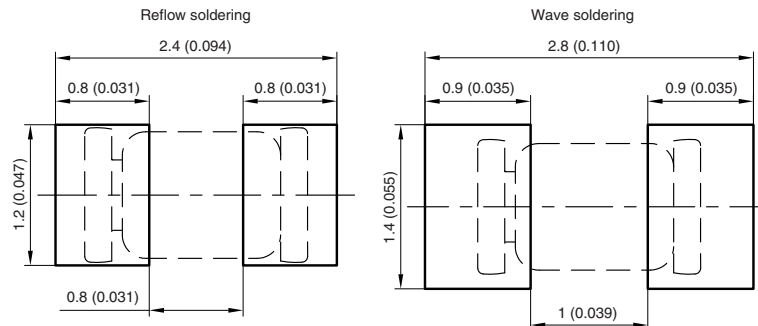

Created - Date: 26.July.1996
 Rev. 13 - Date: 07.June.2006
 Document no.:6.560-5007.01-4
 96 12072



Disclaimer

ALL PRODUCT, PRODUCT SPECIFICATIONS AND DATA ARE SUBJECT TO CHANGE WITHOUT NOTICE TO IMPROVE RELIABILITY, FUNCTION OR DESIGN OR OTHERWISE.

Vishay Intertechnology, Inc., its affiliates, agents, and employees, and all persons acting on its or their behalf (collectively, "Vishay"), disclaim any and all liability for any errors, inaccuracies or incompleteness contained in any datasheet or in any other disclosure relating to any product.

Vishay makes no warranty, representation or guarantee regarding the suitability of the products for any particular purpose or the continuing production of any product. To the maximum extent permitted by applicable law, Vishay disclaims (i) any and all liability arising out of the application or use of any product, (ii) any and all liability, including without limitation special, consequential or incidental damages, and (iii) any and all implied warranties, including warranties of fitness for particular purpose, non-infringement and merchantability.

Statements regarding the suitability of products for certain types of applications are based on Vishay's knowledge of typical requirements that are often placed on Vishay products in generic applications. Such statements are not binding statements about the suitability of products for a particular application. It is the customer's responsibility to validate that a particular product with the properties described in the product specification is suitable for use in a particular application. Parameters provided in datasheets and / or specifications may vary in different applications and performance may vary over time. All operating parameters, including typical parameters, must be validated for each customer application by the customer's technical experts. Product specifications do not expand or otherwise modify Vishay's terms and conditions of purchase, including but not limited to the warranty expressed therein.

Except as expressly indicated in writing, Vishay products are not designed for use in medical, life-saving, or life-sustaining applications or for any other application in which the failure of the Vishay product could result in personal injury or death. Customers using or selling Vishay products not expressly indicated for use in such applications do so at their own risk. Please contact authorized Vishay personnel to obtain written terms and conditions regarding products designed for such applications.

No license, express or implied, by estoppel or otherwise, to any intellectual property rights is granted by this document or by any conduct of Vishay. Product names and markings noted herein may be trademarks of their respective owners.