

## Data sheet

Commercial Art.No.: 25.646.3253.0

PCB pin header 8513 S / 2 GF OB

PCB pin header with pin header, connection method depends on used socket part , 2 poles, pitch: 3.5 mm, type of packing: carton, color: grey



Commercial Art.No.	25.646.3253.0
EAN	4015573508903
Order Unit	100

Certificates / Approvals



## Technical data

### General

Modular spacing	3.5 mm
Soldering process	Wave soldering
Packaging	Carton
Number of poles	2
Number of levels	1
Marking	No
Fastening	None
Mating direction towards (circuit) board	90°

### Technical data

Rated current	8 A
Overvoltage Category I	690 V
Overvoltage Category II	250 V
Overvoltage Category III	125
Rated impulse voltage	2.5 kV

### Technical Data UL/CSA

Voltage UL	300 V
Current field wiring	8 A
Current factory wiring	8 A
Voltage CSA	300 V
Current CSA	5 A

### Other

Type of insulation material	Thermoplastic
Color	Grey
Height	9.2 mm

Length	17.4 mm
Depth	7.15 mm
Material contact base	CuZn
Material contact surface	Sn

#### Classification

ECLASS 11	
ECLASS 8.1	27440402
ETIM 7.0	EC002637
ETIM 6.0	EC002637
ETIM 5.0	EC002637
ETIM 4.0	EC002637

#### Product compliance

ROHS conformity status	Compliant/Exempted
ROHS exceptions	III-6(c)
REACH-SVHC conformity status	Duty-To-Declare
REACH-SVHC substances	Lead
REACH-SVHC CAS numbers	7439-92-1

#### Fits with

Commercial Art.No.:	Article-type description:	Description:
27.631.3253.0	PCB connector 8513 BS / 2 F2 OB	PCB female connector, 2 poles, pitch: 3.5 mm, type of packing: carton, color: grey
25.641.3253.0	PCB connector 8513 B / 2 F OB	PCB female connector with screw connection with rising cage clamp system, 2 poles, max. cross section: 1.5 mm <sup>2</sup> , pitch: 3.5 mm, type of packing: carton, color: grey
25.641.0253.0	PCB connector 8513 B / 2 F	PCB female connector with screw connection with rising cage clamp system, 2 poles, printed version, max. cross section: 1.5 mm <sup>2</sup> , pitch: 3.5 mm, type of packing: carton, color: grey
25.631.3253.0	PCB connector 8513 BFK / 2 F OB	PCB female connector with tension spring connection, 2 poles, max. cross section: 1.5 mm <sup>2</sup> , pitch: 3.5 mm, type of packing: carton, color: grey
25.631.0253.0	PCB connector 8513 BFK / 2 F	PCB female connector with tension spring connection, 2 poles, printed version, max. cross section: 1.5 mm <sup>2</sup> , pitch: 3.5 mm, type of packing: carton, color: grey

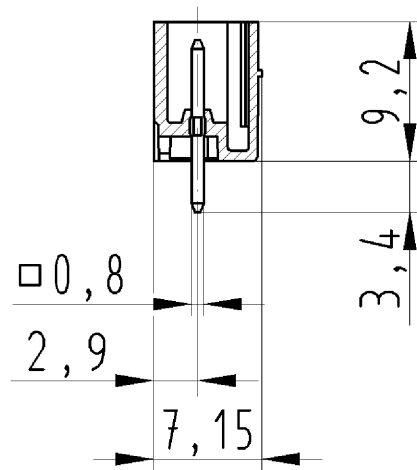
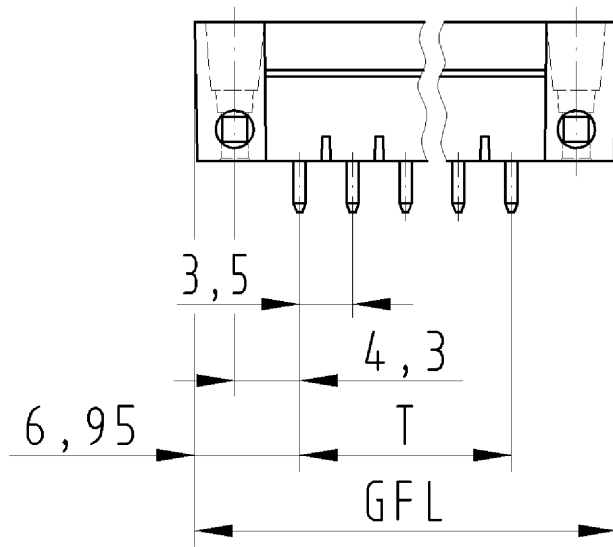

für folgende Tabellen-Zchnng.:  
 25.646.3253.0 8513 S/...GF

LP.STIFTLLEISTE  
 25.646.3253.0 10W  
 24.10.2007 DÜT  
 M 2:1