

Data sheet

Commercial Art.No.: 25.602.5453.0

Pluggable PCB Terminal 8543 / 4 OB

Pluggable-PCB terminal, 4 poles, pitch: 3.5 mm, type of packing: carton,color: grey

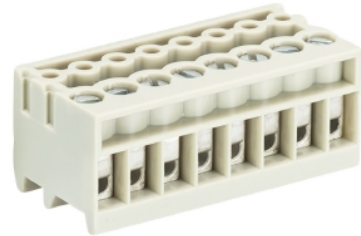

Commercial Art.No.	25.602.5453.0
EAN	4015573203785
Order Unit	50

Certificates / Approvals



Technical data

General

Modular spacing	3.5 mm
Connection type	screw connection
Soldering process	None
Packaging	Carton
Number of poles	4
Marking	No
Mating direction towards connector	90°

Technical data

Nominal cross section	1 mm ²
Rated current	6 A
Overvoltage Category I	690 V
Overvoltage Category II	250 V
Overvoltage Category III	160
Rated impulse voltage	2.5 kV
Wire strip length	5 mm

Connection Data

Minimum cross section solid	0.14 mm ²
Maximum cross section solid	1.5 mm ²
Minimum cross section fine stranded	0.14 mm ²
Maximum cross section fine stranded	1 mm ²
Wire strip length	5 mm

Technical Data UL/CSA

Cross section UL	22-16 AWG
Voltage UL	300 V

Current field wiring	10 A
Current factory wiring	10 A
Cross section CSA	22-16 AWG
Voltage CSA	300 V
Current CSA	10 A

Other

Type of insulation material	Thermoplastic
Color	Grey
Height	11.6 mm
Length	14 mm
Depth	13 mm
Material attachment screw	Steel
Material contact base	CuZn
Material contact surface	Sn

Classification

ECLASS 8.1	27440402
ETIM 7.0	EC002637
ETIM 6.0	EC002637
ETIM 5.0	EC002637

Product compliance

ROHS conformity status	Compliant/Exempted
ROHS exceptions	III-6(c)
REACH-SVHC conformity status	Duty-To-Declare
REACH-SVHC substances	Lead
REACH-SVHC CAS numbers	7439-92-1

Fits with

Commercial Art.No.:	Article-type description:	Description:
Z5.532.0425.0	PCB pin header 8543... /4 90° D1.0/0.8	PCB pin header, 4 poles, pitch: 3.5 mm, type of packing: carton, color:grey
Z5.532.3425.0	PCB pin header 8543... /4 90° D1.0/1.0	PCB pin header, 4 poles, pitch: 3.5 mm, type of packing: carton, color:grey
Z5.531.0425.0	PCB pin header 8543... /4 D1.0/0.8	PCB pin header, 4 poles, pitch: 3.5 mm, type of packing: carton, color:grey
Z5.531.3425.0	PCB pin header 8543... /4 D1.0/1.0	PCB pin header, 4 poles, pitch: 3.5 mm, type of packing: carton, color:grey

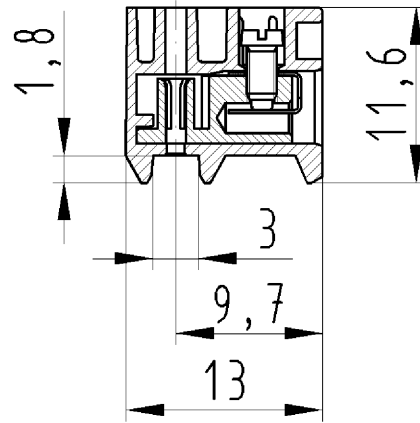
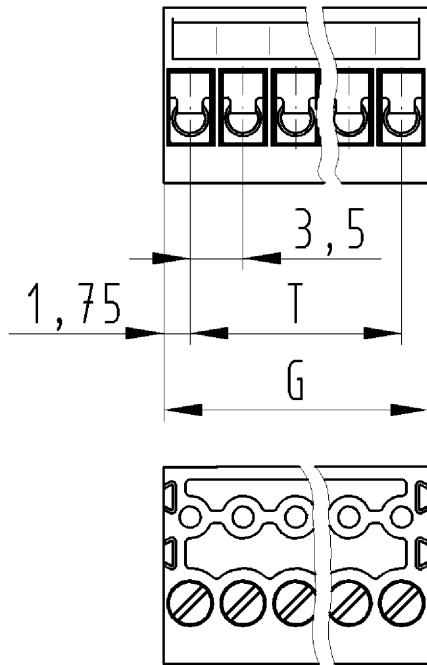

für folgende Tabellen-Zchnng.:
 25.602.5253.0 8543/.. OB

LP. STECKKLEMME
 25.602.5253.0 10W
 30.10.2007 DÜT
 M 2:1