

## Data sheet

Commercial Art.No.: 25.627.3653.0

PCB pin header 8813 S / 6 WF OB

PCB pin header with pin header, connection method depends on used socket part , 6 poles, pitch: 3.81 mm, type of packing: carton, color: grey

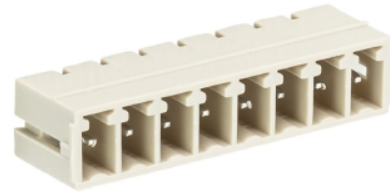

Commercial Art.No.	25.627.3653.0
EAN	4015573350779
Order Unit	50

Certificates / Approvals



## Technical data

### General

Modular spacing	3.81 mm
Soldering process	Wave soldering
Packaging	Carton
Number of poles	6
Number of levels	1
Marking	No
Fastening	None
Mating direction towards (circuit) board	180°

### Technical data

Rated current	8 A
Overvoltage Category I	690 V
Overvoltage Category II	250 V
Overvoltage Category III	125
Rated impulse voltage	2.5 kV

### Technical Data UL/CSA

Voltage UL	300 V
Current field wiring	8 A
Current factory wiring	8 A
Voltage CSA	300 V
Current CSA	5 A

### Other

Type of insulation material	Thermoplastic
Color	Grey
Height	7.15 mm

Length	33.25 mm
Depth	9.2 mm
Material contact base	CuZn
Material contact surface	Sn

#### Classification

ECLASS 11	
ECLASS 8.1	27440402
ETIM 7.0	EC002637
ETIM 6.0	EC002637
ETIM 5.0	EC002637
ETIM 4.0	EC002637

#### Product compliance

ROHS conformity status	Compliant/Exempted
ROHS exceptions	III-6(c)
REACH-SVHC conformity status	Duty-To-Declare
REACH-SVHC substances	Lead
REACH-SVHC CAS numbers	7439-92-1

#### Fits with

Commercial Art.No.:	Article-type description:	Description:
25.621.3653.0	PCB connector 8813 B / 6 F OB	PCB female connector with screw connection with rising cage clamp system, 6 poles, max. cross section: 1.5 mm <sup>2</sup> , pitch: 3.81 mm, type of packing: carton, color: grey
25.621.0653.0	PCB connector 8813 B / 6 F	PCB female connector with screw connection with rising cage clamp system, 6 poles, printed version, max. cross section: 1.5 mm <sup>2</sup> , pitch: 3.81 mm, type of packing: carton, color: grey
25.623.3653.0	PCB connector 8813 B / 6 VR F OB	PCB female connector with screw connection with rising cage clamp system, 6 poles, max. cross section: 1.5 mm <sup>2</sup> , pitch: 3.81 mm, type of packing: carton, color: grey
25.623.0653.0	PCB connector 8813 B / 6 VR F	PCB female connector with screw connection with rising cage clamp system, 6 poles, printed version, max. cross section: 1.5 mm <sup>2</sup> , pitch: 3.81 mm, type of packing: carton, color: grey
25.625.3653.0	PCB connector 8813 B / 6 VL F OB	PCB female connector with screw connection with rising cage clamp system, 6 poles, max. cross section: 1.5 mm <sup>2</sup> , pitch: 3.81 mm, type of packing: carton, color: grey
25.625.0653.0	PCB connector 8813 B / 6 VL F	PCB female connector with screw connection with rising cage clamp system, 6 poles, printed version, max. cross section: 1.5 mm <sup>2</sup> , pitch: 3.81 mm, type of packing: carton, color: grey

für folgende Tabellen-Zchnng.:  
25.627.3253.0 8813 S/...WF

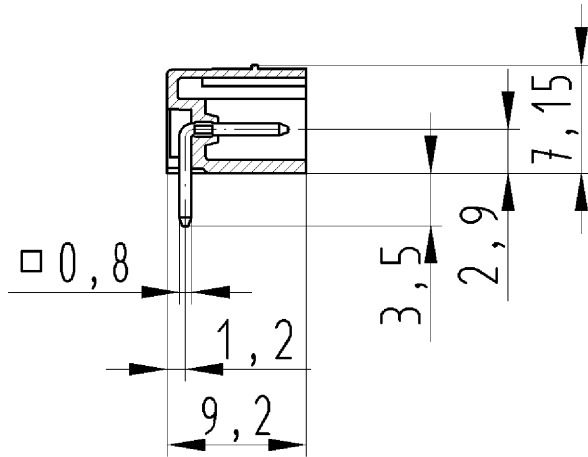
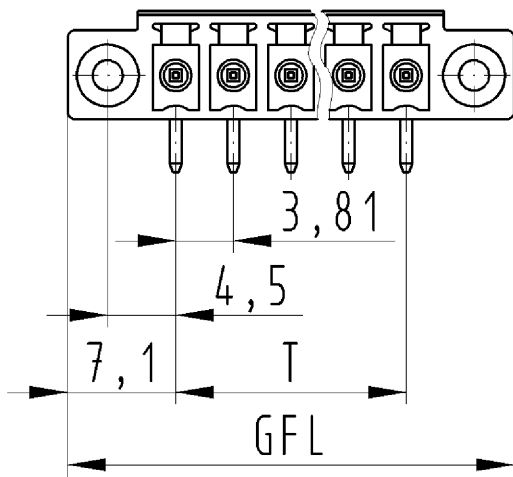

LP.STIFTLEISTE  
25.627.3253.0 10W  
25.10.2007 DÜT  
M 2:1