

## Data sheet

Commercial Art.No.: 25.370.3353.0

PCB pin header 8313 S / 3 G OB

PCB pin header with pin header, connection method depends on used socket part , 3 poles, pitch: 7.5 mm, type of packing: carton, color: grey



Commercial Art.No.	25.370.3353.0
EAN	4015573196612
Order Unit	100

Certificates / Approvals



## Technical data

### General

Modular spacing	7.5 mm
Soldering process	Wave soldering
Packaging	Carton
Number of poles	3
Number of levels	1
Marking	No
Fastening	None
Mating direction towards (circuit) board	90°

### Technical data

Rated current	12 A
Overvoltage Category I	1000 V
Overvoltage Category II	400 V
Overvoltage Category III	250 V
Rated impulse voltage	4 kV

### Technical Data UL/CSA

Voltage UL	300 V
Current field wiring	15 A
Current factory wiring	15 A
Voltage CSA	300 V
Current CSA	15 A

### Other

Type of insulation material	Thermoplastic
Color	Grey
Height	12 mm
Length	21.9 mm

Depth	8.4 mm
Material contact base	CuZn
Material contact surface	Sn

**Classification**

ECLASS 11	
ECLASS 8.1	27440402
ETIM 7.0	EC002637
ETIM 6.0	EC002637
ETIM 5.0	EC002637
ETIM 4.0	EC002637

**Product compliance**

ROHS conformity status	Compliant
REACH-SVHC conformity status	Compliant

**Fits with**

Commercial Art.No.:	Article-type description:	Description:
25.360.3353.0	PCB connector 8313 B / 3 OB	PCB female connector with screw connection with rising cage clamp system, 3 poles, max. cross section: 2.5 mm <sup>2</sup> , pitch: 7.5 mm, type of packing: carton, color: grey
25.360.0353.0	PCB connector 8313 B / 3	PCB female connector with screw connection with rising cage clamp system, 3 poles, printed version, max. cross section: 2.5 mm <sup>2</sup> , pitch: 7.5 mm, type of packing: carton, color: grey

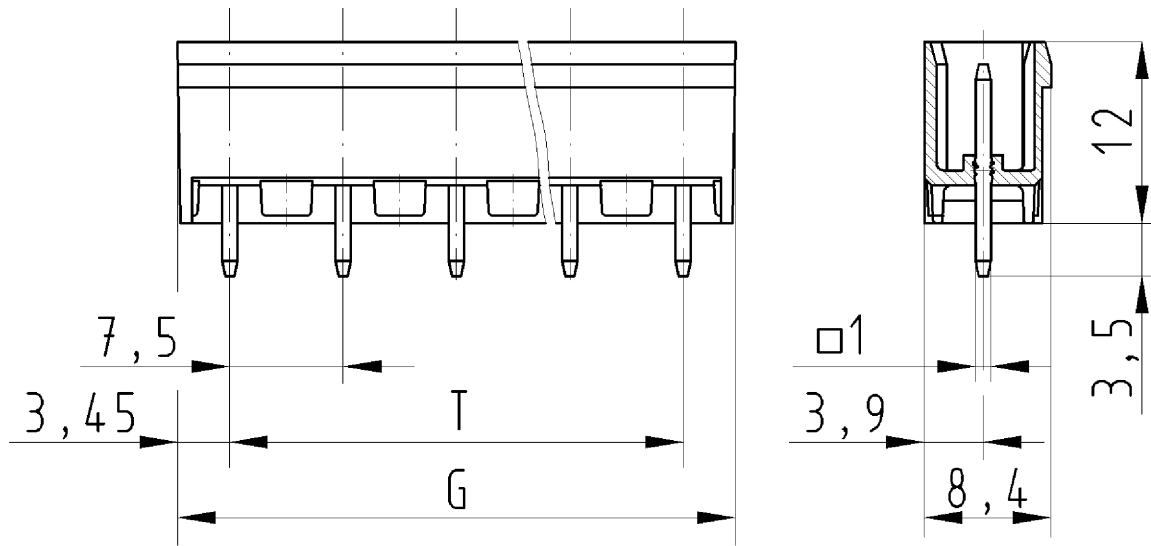

für folgende Tabellen-Zchnng.:  
 25.370.3253.0 8313 S/...G

LP. STIFTLEISTE  
 25.370.3253.0 10W  
 09.11.2007 SCJ  
 M 2:1