

STEREO AUDIO CODEC WITH USB INTERFACE, SINGLE-ENDED ANALOG INPUT/OUTPUT AND S/PDIF

FEATURES

- **PCM2901: Without S/PDIF**
- **PCM2903: With S/PDIF**
- **On-Chip USB Interface**
 - With Full-Speed Transceivers
 - Fully Compliant With USB 1.1 Specification
 - Certified by USB-IF
 - Partially Programmable Descriptors ⁽¹⁾
 - USB Adaptive Mode for Playback
 - USB Asynchronous Mode for Record
 - Self-Powered
- **16-Bit Delta-Sigma ADC and DAC**
- **Sampling Rates**
 - DAC: 32, 44.1, 48 kHz
 - ADC: 8, 11.025, 16, 22.05, 32, 44.1, 48 kHz
- **On-Chip Clock Generator With Single 12-MHz Clock Source**
- **Single Power Supply: 3.3 V Typical**
- **Stereo ADC**
 - Analog Performance at $V_{CC} = V_{CCP1} = V_{CCP2} = V_{CCX} = V_{DD} = 3.3\text{ V}$
 - THD+N = 0.01%
 - SNR = 89 dB
 - Dynamic Range = 89 dB
 - Decimation Digital Filter
 - Pass-Band Ripple = $\pm 0.05\text{ dB}$
 - Stop-Band Attenuation = -65 dB
 - Single-Ended Voltage Input
 - Antialiasing Filter Included
 - Digital LCF Included
- **Stereo DAC**
 - Analog Performance at $V_{CC} = V_{CCP1} = V_{CCP2} = V_{CCX} = V_{DD} = 3.3\text{ V}$
 - THD+N = 0.005%
 - SNR = 96 dB
 - Dynamic Range = 93 dB
 - Oversampling Digital Filter
 - Pass-Band Ripple = $\pm 0.1\text{ dB}$
 - Stop-Band Attenuation = -43 dB
 - Single-Ended Voltage Output
 - Analog LPF Included
- **Multifunctions**
 - Human Interface Device (HID) Volume \pm Control and Mute Control
 - Suspend Flag
- **Package: 28-Pin SSOP**

APPLICATIONS

- USB Audio Speaker
- USB Headset
- USB Monitor
- USB Audio Interface Box

DESCRIPTION

The PCM2901/2903 is TI's single-chip USB stereo audio codec with USB-compliant full-speed protocol controller and S/PDIF (only PCM2903). The USB protocol controller works with no software code, but the USB descriptors can be modified in some areas (for example, vendor ID/product ID). The PCM2901/2903 employs SpAct™ architecture, TI's unique system that recovers the audio clock from USB packet data. On-chip analog PLLs with SpAct enable playback and record with low clock jitter and with independent playback and record sampling rates.

(1) The descriptor can be modified by changing a mask.



Please be aware that an important notice concerning availability, standard warranty, and use in critical applications of Texas Instruments semiconductor products and disclaimers thereto appears at the end of this data sheet.

SpAct is a trademark of Texas Instruments.

System Two, Audio Precision are trademarks of Audio Precision, Inc.

All other trademarks are the property of their respective owners.



This integrated circuit can be damaged by ESD. Texas Instruments recommends that all integrated circuits be handled with appropriate precautions. Failure to observe proper handling and installation procedures can cause damage.

ESD damage can range from subtle performance degradation to complete device failure. Precision integrated circuits may be more susceptible to damage because very small parametric changes could cause the device not to meet its published specifications.

ORDERING INFORMATION

PCM2901						
PRODUCT	PACKAGE-LEAD	PACKAGE DESIGNATOR	SPECIFIED TEMPERATURE RANGE	PACKAGE MARKING	ORDERING NUMBER ⁽¹⁾	TRANSPORT MEDIA
PCM2901E	SSOP-28	28DB	–25°C to 85°C	PCM2901E	PCM2901E	Rails
					PCM2903E/2K	Tape and reel

(1) Models with a slash (/) are available only in tape and reel in the quantities indicated (e.g., /2K indicates 2000 devices per reel). Ordering 2000 pieces of PCM2901E/2K gets a single 2000-piece tape and reel.

PCM2903						
PRODUCT	PACKAGE-LEAD	PACKAGE DESIGNATOR	SPECIFIED TEMPERATURE RANGE	PACKAGE MARKING	ORDERING NUMBER ⁽¹⁾	TRANSPORT MEDIA
PCM2903E	SSOP-28	28DB	–25°C to 85°C	PCM2903E	PCM2903E	Rails
					PCM2903E/2K	Tape and reel

(1) Models with a slash (/) are available only in tape and reel in the quantities indicated (e.g., /2K indicates 2000 devices per reel). Ordering 2000 pieces of PCM2903E/2K gets a single 2000-piece tape and reel.

ABSOLUTE MAXIMUM RATINGS

over operating free-air temperature range (unless otherwise noted) ⁽¹⁾

		PCM2901/PCM2903	UNIT
Supply voltage, V_{CC} , V_{CCP1} , V_{CCP2} , V_{CCX} , V_{DD}		–0.3 to 4	V
Supply voltage differences, V_{CC} , V_{CCP1} , V_{CCP2} , V_{CCX} , V_{DD}		±0.1	V
Ground voltage differences, AGNDC, AGNDP, AGNDX, DGND, DGNDU		±0.1	V
Digital input voltage	SEL0, SEL1, TEST0 (DIN) ⁽²⁾	–0.3 to 6.5	V
	D+, D–, HID0, HID1, HID2, XTI, XTO, TEST1 (DOUT) ⁽²⁾ , \overline{SSPND}	–0.3 to $(V_{DD} + 0.3) < 4$	V
Analog input voltage V_{INL} , V_{INR} , V_{COM} , V_{OUTR} , V_{OUTL}		–0.3 to $(V_{CC} + 0.3) < 4$	V
Input current (any pins except supplies)		±10	mA
Ambient temperature under bias		–40 to 125	°C
Storage temperature, T_{stg}		–55 to 150	°C
Junction temperature T_J		150	°C
Lead temperature (soldering)		260	°C, 5 s
Package temperature (IR reflow, peak)		250	°C

(1) Stresses beyond those listed under *absolute maximum ratings* may cause permanent damage to the device. These are stress ratings only, and functional operation of the device at these or any other conditions beyond those indicated under *recommended operating conditions* is not implied. Exposure to absolute-maximum-rated conditions for extended periods may affect device reliability.

(2) (): PCM2903

ELECTRICAL CHARACTERISTICS

all specifications at $T_A = 25^\circ\text{C}$, $V_{\text{CCC}} = V_{\text{CCP1}} = V_{\text{CCP2}} = V_{\text{CCX}} = V_{\text{DD}} = 3.3\text{ V}$, $f_S = 44.1\text{ kHz}$, $f_{\text{IN}} = 1\text{ kHz}$, 16-bit data, unless otherwise noted

PARAMETER		TEST CONDITIONS	MIN	TYP	MAX	UNIT
DIGITAL INPUT/OUTPUT						
Host interface		Apply USB Revision 1.1, full speed				
Audio data format		USB isochronous data format				
INPUT LOGIC						
V_{IH}	High-level input voltage	D+, D–	2		V_{DD}	VDC
		XTI, HID0, HID1, and HID2	$0.7 V_{\text{DD}}$		V_{DD}	
		SEL0, SEL1	2		5.25	
		DIN (PCM2903)	$0.7 V_{\text{DD}}$		5.25	
V_{IL}	Low-level input voltage	D+, D–	V_{DD}		0.8	VDC
		XTI, HID0, HID1, and HID2			$0.3 V_{\text{DD}}$	
		SEL0, SEL1			0.8	
		DIN (PCM2903)			$0.3 V_{\text{DD}}$	
I_{IH}	High-level input current	D+, D–, XTI, SEL0, SEL1	$V_{\text{IN}} = 3.3\text{ V}$		± 10	μA
		HID0, HID1, and HID2	$V_{\text{IN}} = 3.3\text{ V}$		50 80	
		DIN (PCM2903)	$V_{\text{IN}} = 3.3\text{ V}$		65 100	
I_{IL}	Low-level input current	D+, D–, XTI, SEL0, SEL1	$V_{\text{IN}} = 0\text{ V}$		± 10	μA
		HID0, HID1, and HID2	$V_{\text{IN}} = 0\text{ V}$		± 10	
		DIN (PCM2903)	$V_{\text{IN}} = 0\text{ V}$		± 10	
OUTPUT LOGIC						
V_{OH}	High-level output voltage	D+, D–		2.8		VDC
		DOUT (PCM2903)	$I_{\text{OH}} = -4\text{ mA}$	2.8		
		SSPND	$I_{\text{OH}} = -2\text{ mA}$	2.8		
V_{OL}	Low-level output voltage	D+, D–			0.3	VDC
		DOUT (PCM2903)	$I_{\text{OL}} = 4\text{ mA}$		0.5	
		SSPND	$I_{\text{OL}} = 2\text{ mA}$		0.5	
CLOCK FREQUENCY						
Input clock frequency, XTI			11.994	12	12.006	MHz

ELECTRICAL CHARACTERISTICS

All specifications at $T_A = 25^\circ\text{C}$, $V_{\text{CC}} = V_{\text{CCP1}} = V_{\text{CCP2}} = V_{\text{CCX}} = V_{\text{DD}} = 3.3\text{ V}$, $f_S = 44.1\text{ kHz}$, $f_{\text{IN}} = 1\text{ kHz}$, 16-bit data, unless otherwise noted

PARAMETER		TEST CONDITIONS	MIN	TYP	MAX	UNIT
ADC CHARACTERISTICS						
Resolution				8, 16		bits
Audio data channel				1, 2		channel
Clock Frequency						
f_S	Sampling frequencies		8, 11.025, 16, 22.05, 32, 44.1, 48			kHz
DC Accuracy						
Gain mismatch, channel-to-channel				± 1	± 5	% of FSR
Gain error				± 2	± 10	% of FSR
Bipolar zero error				± 0		% of FSR
Dynamic Performance⁽¹⁾						
THD+N	Total harmonic distortion plus noise	$V_{\text{IN}} = -0.5\text{ dB}$		0.01%	0.02%	
		$V_{\text{IN}} = -60\text{ dB}$		5%		
Dynamic range		A-weighted	81	89		dB
SNR	Signal-to-noise ratio	A-weighted	81	89		dB
Channel separation			80	85		dB
Analog Input						
Input voltage				$0.6 V_{\text{CC}}$		Vp-p
Center voltage				$0.5 V_{\text{CC}}$		V
Input impedance				30		k Ω
Antialiasing filter frequency response		-3 dB		150		kHz
		$f_{\text{IN}} = 20\text{ kHz}$		-0.08		dB
Digital Filter Performance						
Pass band					$0.454 f_S$	Hz
Stop band			$0.563 f_S$			Hz
Pass-band ripple					± 0.05	dB
Stop-band attenuation			-65			dB
t_d	Delay time			$17.4/f_S$		s
LCF frequency response		-3 dB		$0.078 f_S$		MHz

(1) $f_{\text{IN}} = 1\text{ kHz}$, using a System Two™ audio measurement system by Audio Precision™ in RMS mode with a 20-kHz LPF and 400-Hz HPF in the calculation.

ELECTRICAL CHARACTERISTICS

all specifications at $T_A = 25^\circ\text{C}$, $V_{\text{CC}} = V_{\text{CCP1}} = V_{\text{CCP2}} = V_{\text{CCX}} = V_{\text{DD}} = 3.3\text{ V}$, $f_S = 44.1\text{ kHz}$, $f_{\text{IN}} = 1\text{ kHz}$, 16-bit data, unless otherwise noted

PARAMETER		TEST CONDITIONS	MIN	TYP	MAX	UNIT
DAC CHARACTERISTICS						
Resolution			8, 16			bits
Audio data channel			1, 2			channel
Clock Frequency						
f_S	Sampling frequencies		32, 44.1, 48			kHz
DC Accuracy						
Gain mismatch channel-to-channel			± 1	± 5		% of FSR
Gain error			± 2	± 10		% of FSR
Bipolar zero error			± 2			% of FSR
Dynamic Performance⁽¹⁾						
THD+N	Total harmonic distortion plus noise	$V_{\text{OUT}} = 0\text{ dB}$	0.005%	0.016%		
		$V_{\text{OUT}} = -60\text{ dB}$	3%			
Dynamic range		EIAJ, A-weighted	87	93		dB
SNR	Signal-to-noise ratio	EIAJ, A-weighted	90	96		dB
Channel separation			86	92		dB
Analog Output						
V_O	Output voltage		0.6 V_{CC}			Vp-p
Center voltage			0.5 V_{CC}			V
Load impedance		AC coupling	10			k Ω
LPF frequency response		-3 dB	250			kHz
		$f = 20\text{ kHz}$	-0.03			dB
Digital Filter Performance						
Pass band			0.445 f_S			Hz
Stop band			0.555 f_S			Hz
Pass-band ripple			± 0.1			dB
Stop-band attenuation			-43			dB
t_d	Delay time		14.3/ f_S			s
POWER SUPPLY REQUIREMENTS						
Voltage range (V_{DD} , V_{CC} , V_{CCP1} , V_{CCP2} , V_{CCX})			3	3.3	3.6	VDC
Supply current		ADC, DAC operation	54		70	mA
		Suspend mode ⁽²⁾	210			μA
P_D	Power dissipation	ADC, DAC operation	178		252	mW
		Suspend mode ⁽²⁾	0.69			
TEMPERATURE RANGE						
Operaton temperature			-25		85	$^\circ\text{C}$
θ_{JA}	Thermal resistance		100			$^\circ\text{C/W}$

(1) $f_{\text{OUT}} = 1\text{ kHz}$, using a System Two audio measurement system by Audio Precision in RMS mode with a 20-kHz LPF and 400-Hz HPF.

(2) Under USB suspend state

PIN ASSIGNMENTS

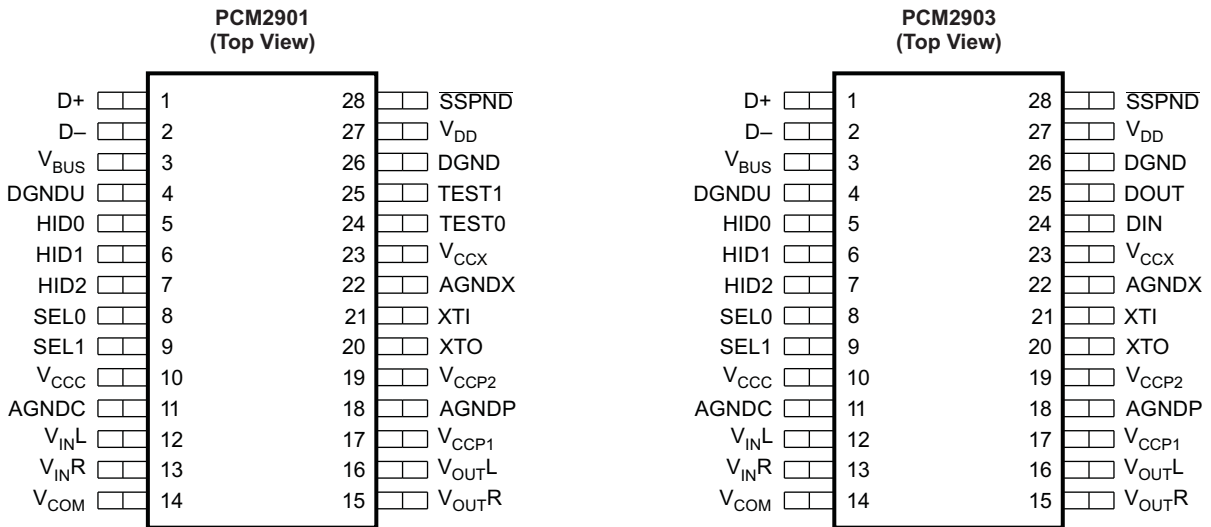

P0007-07

PCM2901 TERMINAL FUNCTIONS

TERMINAL		I/O	DESCRIPTION
NAME	NO.		
AGNDC	11	–	Analog ground for codec
AGNDP	18	–	Analog ground for PLL
AGNDX	22	–	Analog ground for oscillator
D–	2	I/O	USB differential input/output minus ⁽¹⁾
D+	1	I/O	USB differential input/output plus ⁽¹⁾
DGND	26	–	Digital ground
DGNDU	4	–	Digital ground for USB transceiver
HID0	5	I	HID key state input (mute), active-high ⁽²⁾
HID1	6	I	HID key state input (volume up), active-high ⁽²⁾
HID2	7	I	HID key state input (volume down), active-high ⁽²⁾
SEL0	8	I	Must be set to high ⁽³⁾
SEL1	9	I	Connected to the USB port of V _{BUS} ⁽³⁾
SSPND	28	O	Suspend flag, active-low (Low: suspend, High: operational)
TEST0	24	I	Test pin, must be connected to GND
TEST1	25	O	Test pin, must be left open
V _{BUS}	3	–	Must be connected to V _{DD}
V _{CC}	10	–	Analog power supply for codec ⁽⁴⁾
V _{CCP1}	17	–	Analog power supply for PLL ⁽⁴⁾
V _{CCP2}	19	–	Analog power supply for PLL ⁽⁴⁾
V _{CCX}	23	–	Analog power supply for oscillator ⁽⁴⁾
V _{COM}	14	–	Common for ADC/DAC (V _{CC} /2) ⁽⁴⁾
V _{DD}	27	–	Digital power supply ⁽⁴⁾
V _{INL}	12	I	ADC analog input for L-channel
V _{INR}	13	I	ADC analog input for R-channel
V _{OUTL}	16	O	DAC analog output for L-channel
V _{OUTR}	15	O	DAC analog output for R-channel
XTI	21	I	Crystal oscillator input ⁽⁵⁾
XTO	20	O	Crystal oscillator output

(1) LV-TTL level

(2) 3.3-V CMOS-level input with internal pulldown. This pin informs the PC of serviceable control signals such as mute, volume up, or volume down, which have no direct connection with the internal DAC or ADC. See the [Interface #3](#) and [End-Points](#) sections.

(3) TTL Schmitt trigger, 5-V tolerant

(4) Connect a decoupling capacitor to GND.

(5) 3.3-V CMO- level input

PCM2903 TERMINAL FUNCTIONS

TERMINAL		I/O	DESCRIPTION
NAME	NO.		
AGNDC	11	–	Analog ground for codec
AGNDP	18	–	Analog ground for PLL
AGNDX	22	–	Analog ground for oscillator
D–	2	I/O	USB differential input/output minus ⁽¹⁾
D+	1	I/O	USB differential input/output plus ⁽¹⁾
DGND	26	–	Digital ground
DGNDU	4	–	Digital ground for USB transceiver
DIN	24	I	S/PDIF input ⁽²⁾
DOUT	25	O	S/PDIF output
HID0	5	I	HID key state input (mute), active-high ⁽³⁾
HID1	6	I	HID key state input (volume up), active-high ⁽³⁾
HID2	7	I	HID key state input (volume down), active-high ⁽³⁾
SEL0	8	I	Must be set to high ⁽⁴⁾
SEL1	9	I	Connected to the USB port of V _{BUS} ⁽⁴⁾
$\overline{\text{SSPND}}$	28	O	Suspend flag, active-low (Low: suspend, High: operational)
V _{BUS}	3	–	Must be connected to V _{DD}
V _{CC}	10	–	Analog power supply for codec ⁽⁵⁾
V _{CCP1}	17	–	Analog power supply for PLL ⁽⁵⁾
V _{CCP2}	19	–	Analog power supply for PLL ⁽⁵⁾
V _{CCX}	23	–	Analog power supply for oscillator ⁽⁵⁾
V _{COM}	14	–	Common for ADC/DAC (V _{CC} /2) ⁽⁵⁾
V _{DD}	27	–	Digital power supply ⁽⁵⁾
V _{INL}	12	I	ADC analog input for L-channel
V _{INR}	13	I	ADC analog input for R-channel
V _{OUTL}	16	O	DAC analog output for L-channel
V _{OUTR}	15	O	DAC analog output for R-channel
XTI	21	I	Crystal oscillator input ⁽⁶⁾
XTO	20	O	Crystal oscillator output

- (1) LV-TTL level
- (2) 3.3-V CMOS-level input with internal pulldown, 5-V tolerant
- (3) 3.3-V CMOS-level input with internal pulldown. This pin informs the PC of serviceable control signals such as mute, volume up, or volume down, which have no direct connection with the internal DAC or ADC. See the [Interface #3](#) and [End-Points](#) sections.
- (4) TTL Schmitt trigger, 5-V tolerant
- (5) Connect a decoupling capacitor to GND.
- (6) 3.3-V CMOS-level input

PCM2901 FUNCTIONAL BLOCK DIAGRAM

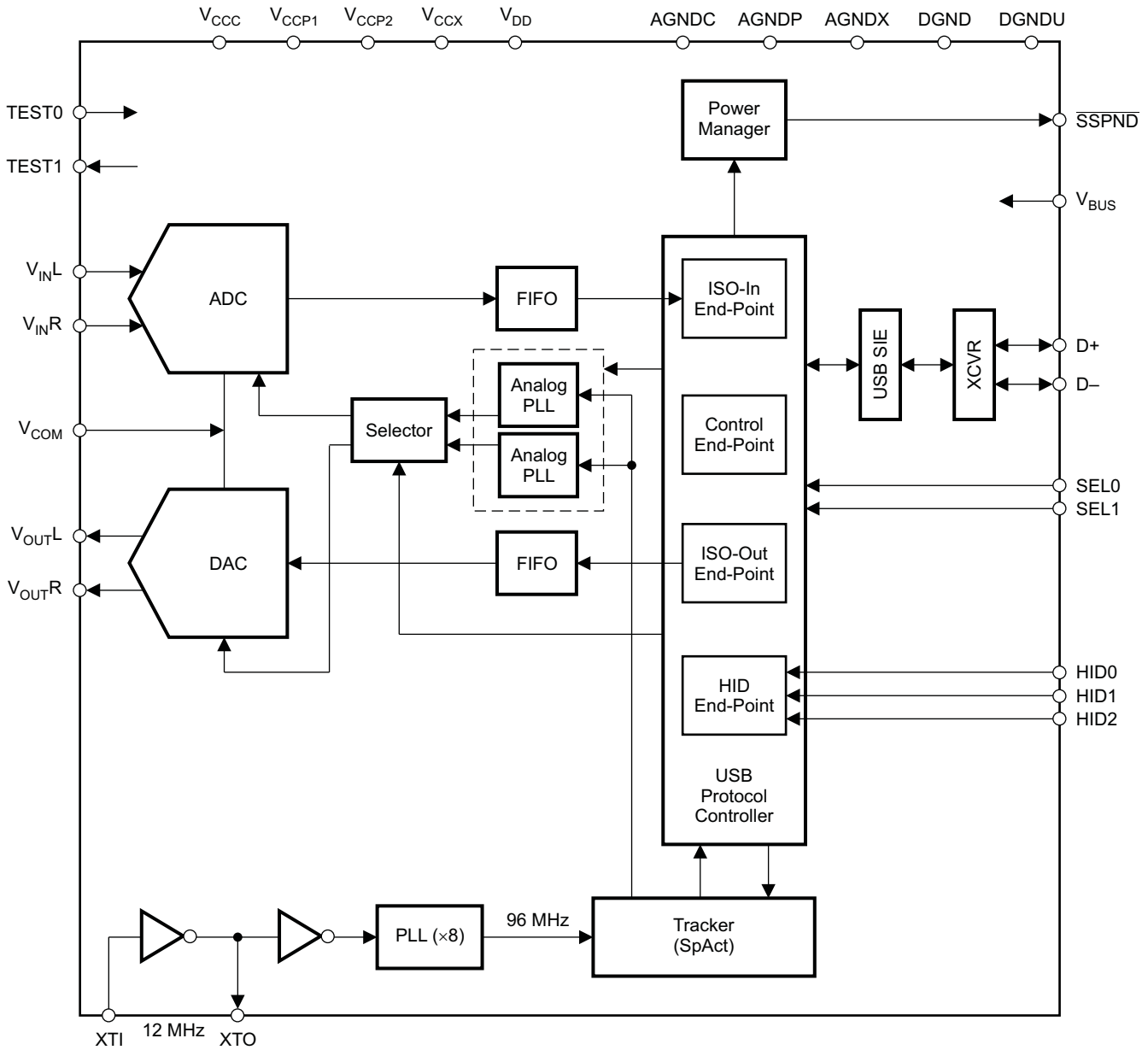

B0238-02

PCM2903 FUNCTIONAL BLOCK DIAGRAM

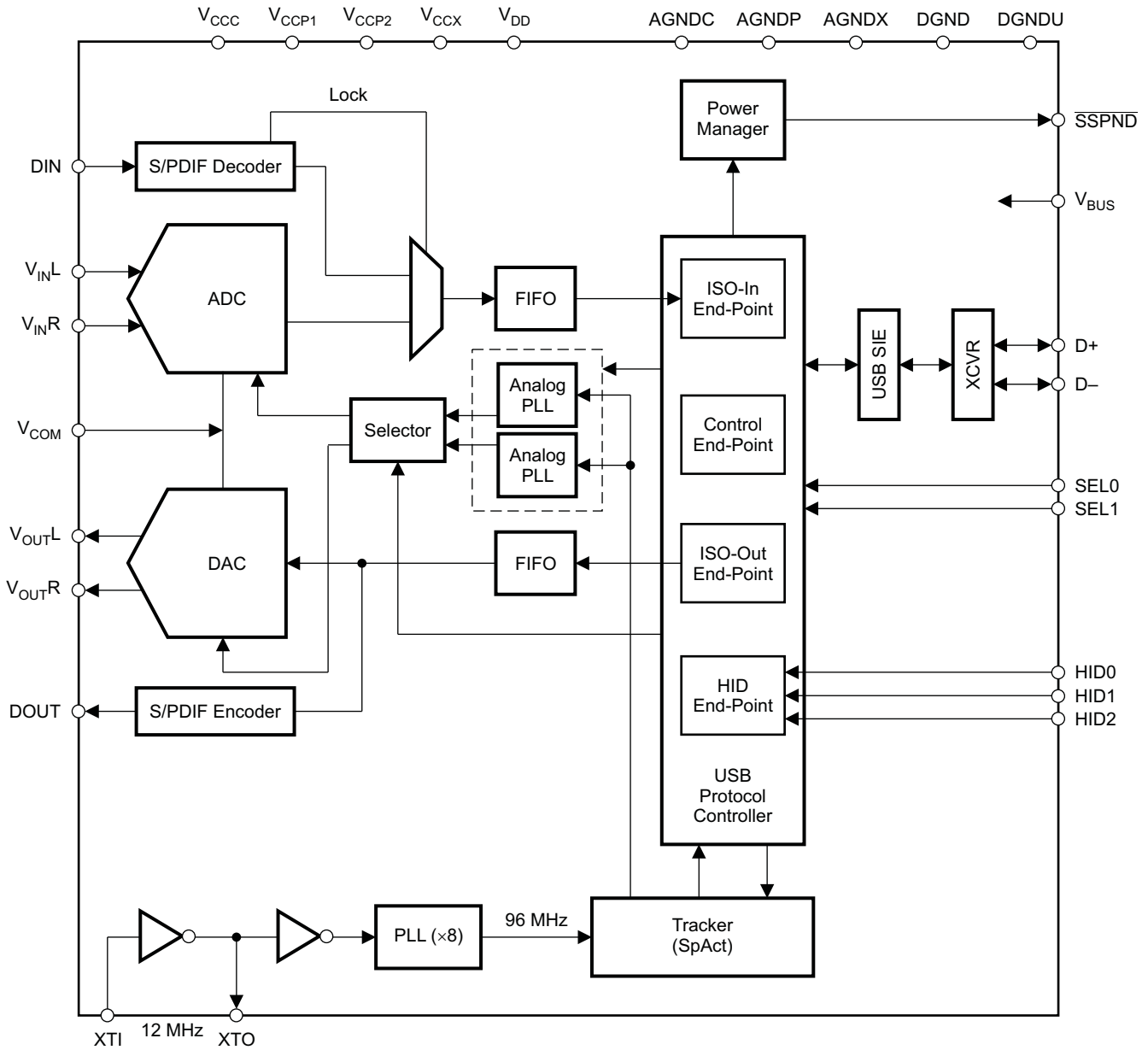

B0239-02

PCM2901/2903 BLOCK DIAGRAM OF ANALOG FRONT-END (RIGHT CHANNEL)

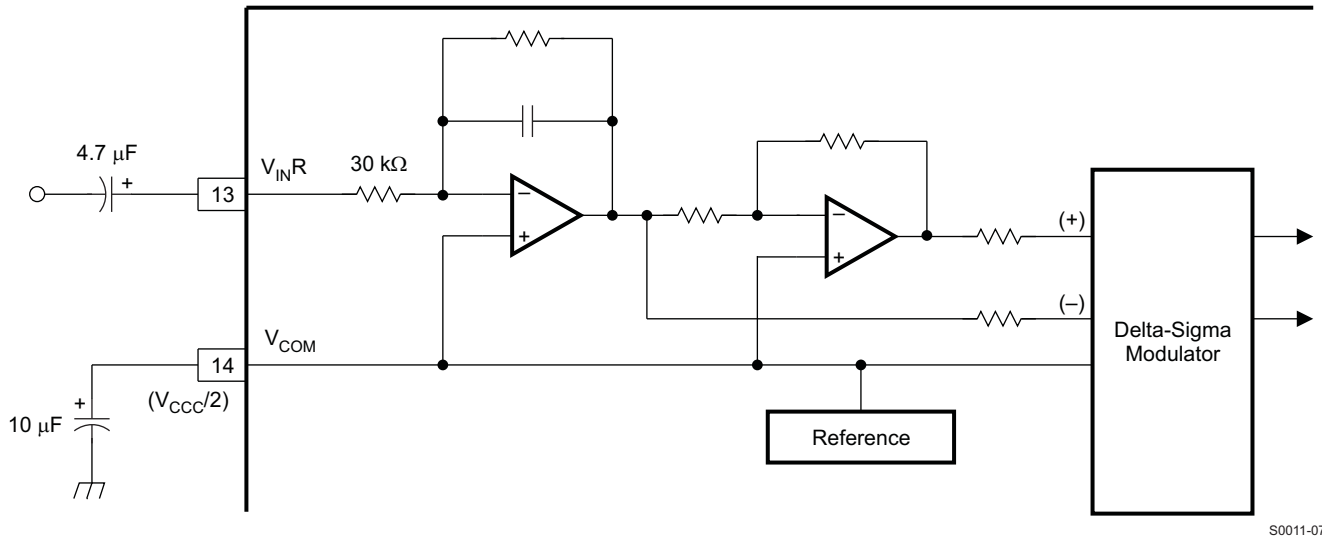

TYPICAL CHARACTERISTICS

All specifications at $T_A = 25^\circ\text{C}$, $V_{DD} = V_{CC} = V_{CCP1} = V_{CCP2} = V_{CCx} = 3.3\text{ V}$, $f_s = 44.1\text{ kHz}$, $f_{IN} = 1\text{ kHz}$, 16-bit data, unless otherwise noted.

ADC

**TOTAL HARMONIC DISTORTION + NOISE at -0.5 dB
vs
FREE-AIR TEMPERATURE**

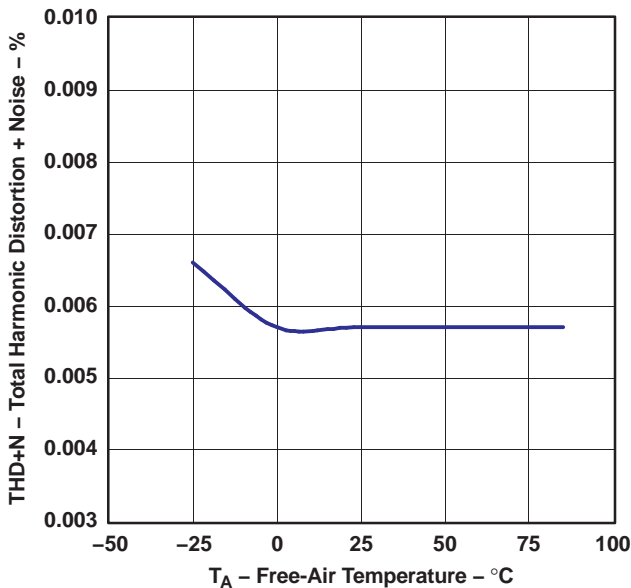

Figure 1.

**DYNAMIC RANGE and SNR
vs
FREE-AIR TEMPERATURE**

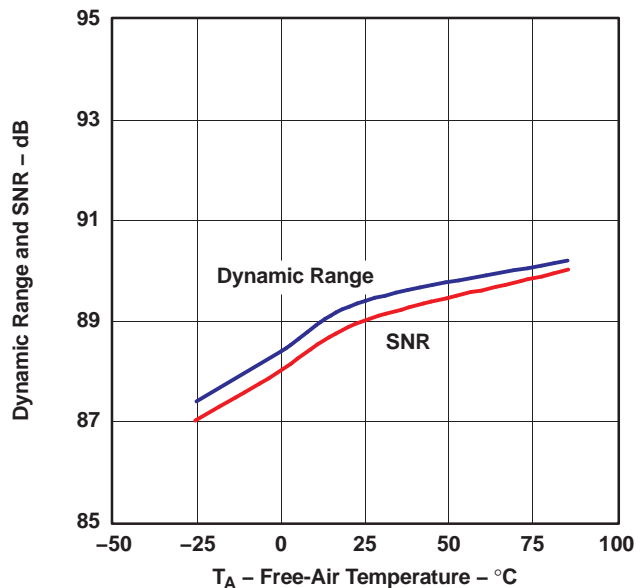
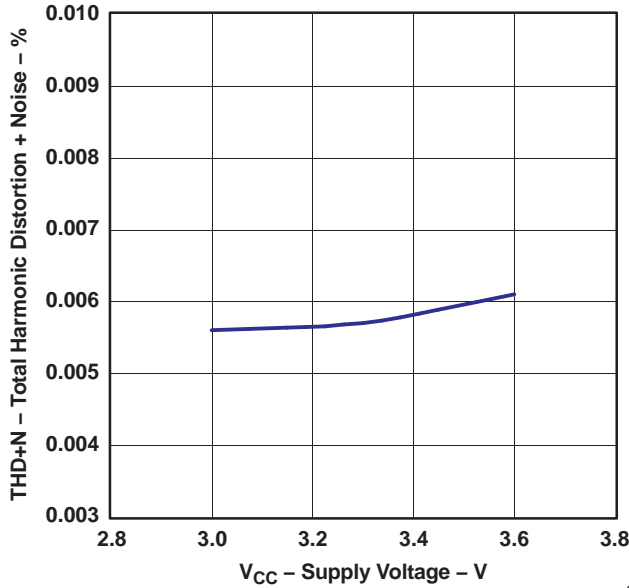

Figure 2.

TYPICAL CHARACTERISTICS (continued)

All specifications at $T_A = 25^\circ\text{C}$, $V_{DD} = V_{CC} = V_{CCP1} = V_{CCP2} = V_{CCx} = 3.3\text{ V}$, $f_s = 44.1\text{ kHz}$, $f_{IN} = 1\text{ kHz}$, 16-bit data, unless otherwise noted.

**TOTAL HARMONIC DISTORTION + NOISE at -0.5 dB
vs
SUPPLY VOLTAGE**



G003

Figure 3.

**DYNAMIC RANGE and SNR
vs
SUPPLY VOLTAGE**

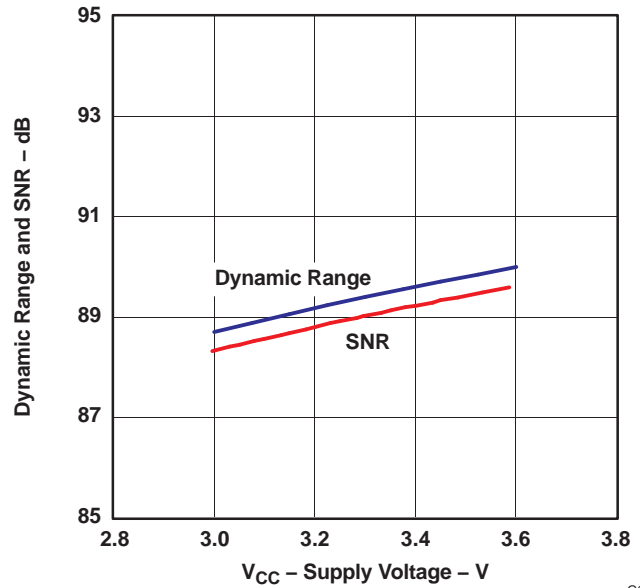

G004

Figure 4.

**TOTAL HARMONIC DISTORTION + NOISE at -0.5 dB
vs
SAMPLING FREQUENCY**

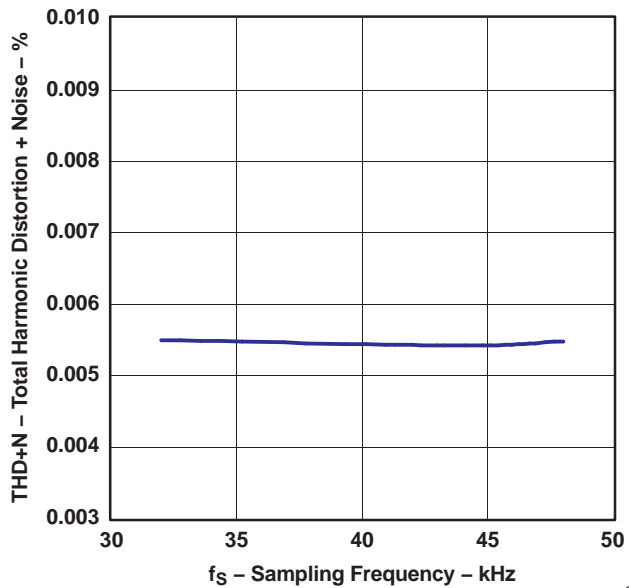

G005

Figure 5.

**DYNAMIC RANGE and SNR
vs
SAMPLING FREQUENCY**

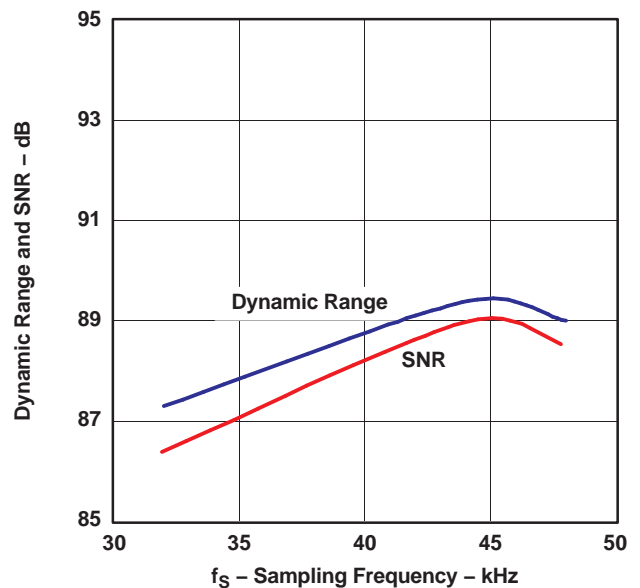

G006

Figure 6.

TYPICAL CHARACTERISTICS (continued)

All specifications at $T_A = 25^\circ\text{C}$, $V_{DD} = V_{CC} = V_{CCP1} = V_{CCP2} = V_{CCx} = 3.3\text{ V}$, $f_s = 44.1\text{ kHz}$, $f_{IN} = 1\text{ kHz}$, 16-bit data, unless otherwise noted.

DAC

TOTAL HARMONIC DISTORTION + NOISE at 0 dB
vs
FREE-AIR TEMPERATURE

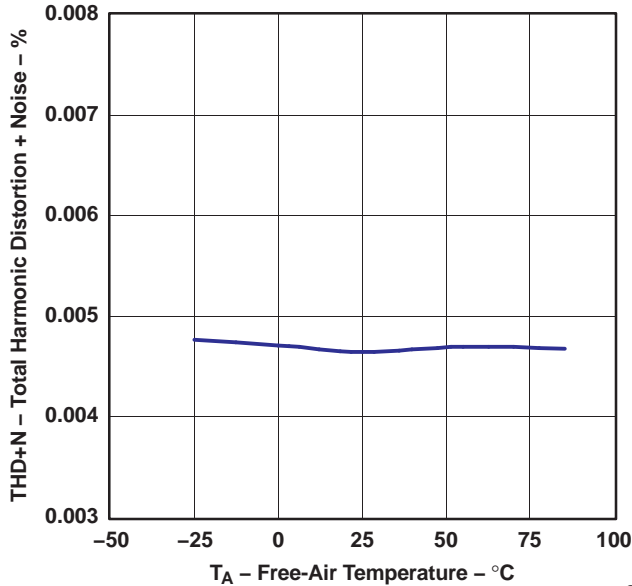

G007

Figure 7.

DYNAMIC RANGE and SNR
vs
FREE-AIR TEMPERATURE

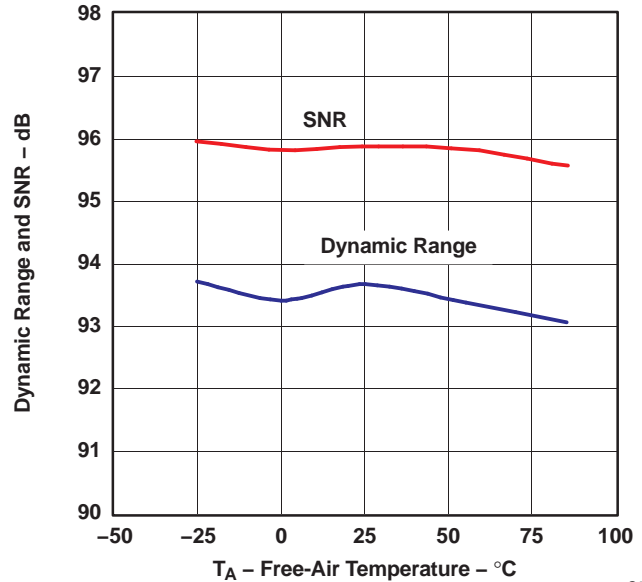

G008

Figure 8.

TOTAL HARMONIC DISTORTION + NOISE at 0 dB
vs
SUPPLY VOLTAGE

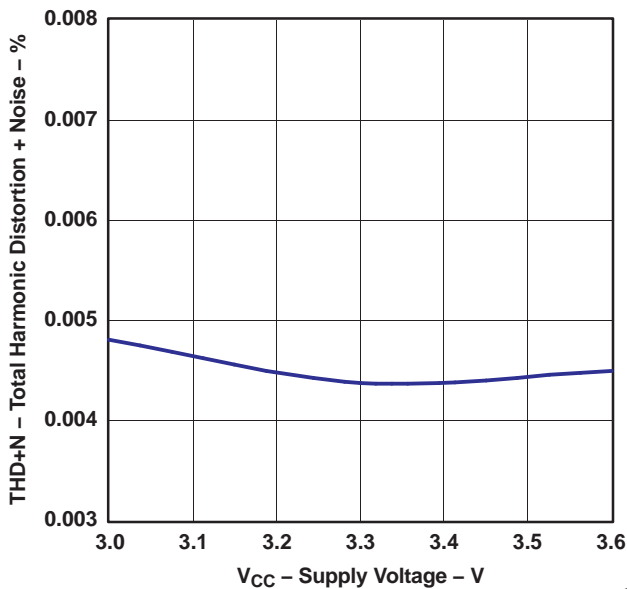

G009

Figure 9.

DYNAMIC RANGE and SNR
vs
SUPPLY VOLTAGE

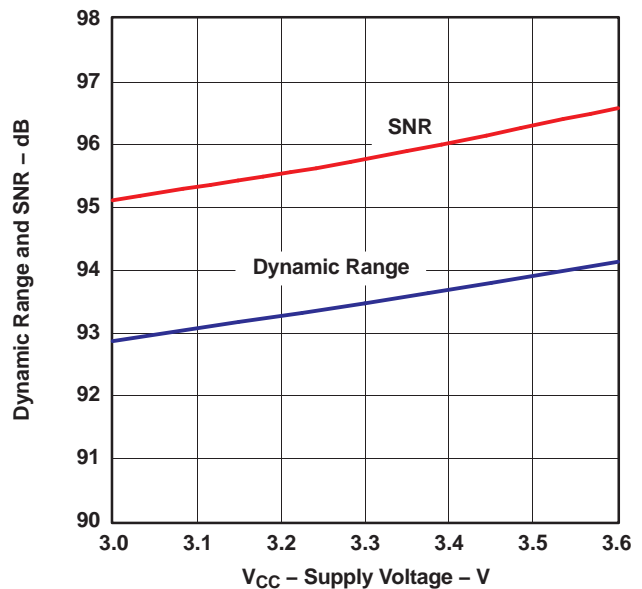

G010

Figure 10.

TYPICAL CHARACTERISTICS (continued)

All specifications at $T_A = 25^\circ\text{C}$, $V_{DD} = V_{CCC} = V_{CCP1} = V_{CCP2} = V_{CCx} = 3.3\text{ V}$, $f_s = 44.1\text{ kHz}$, $f_{IN} = 1\text{ kHz}$, 16-bit data, unless otherwise noted.

**TOTAL HARMONIC DISTORTION + NOISE at 0 dB
VS
SAMPLING FREQUENCY**

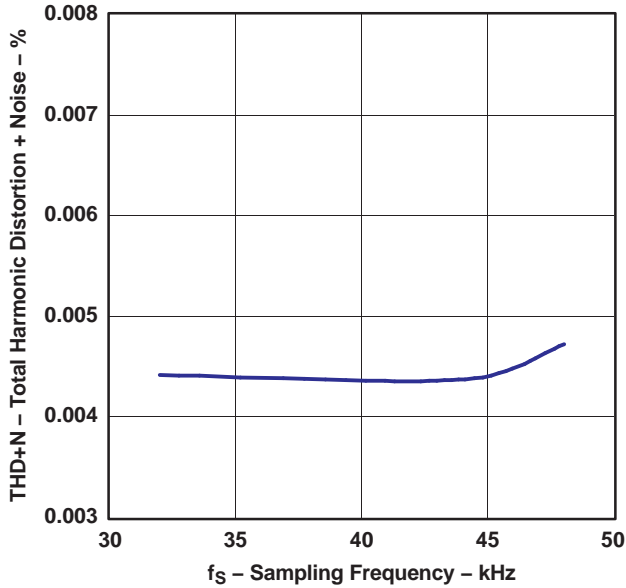

Figure 11.

G011

**DYNAMIC RANGE and SNR
VS
SAMPLING FREQUENCY**

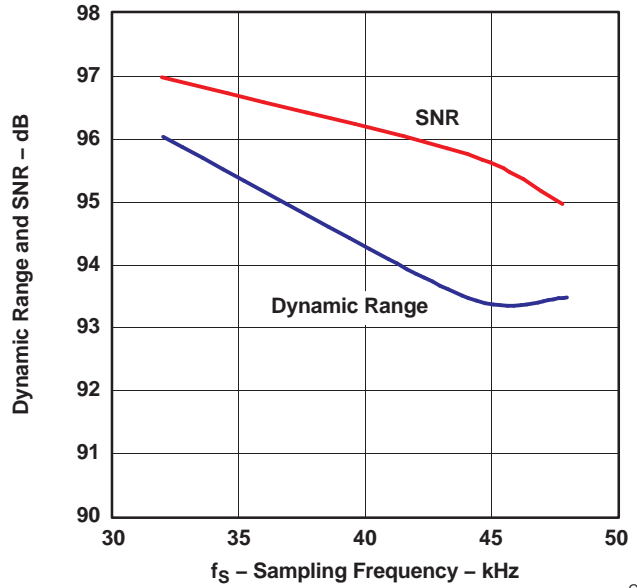

Figure 12.

G012

ADC OUTPUT SPECTRUM

OUTPUT SPECTRUM (-0.5 dB, N = 8192)

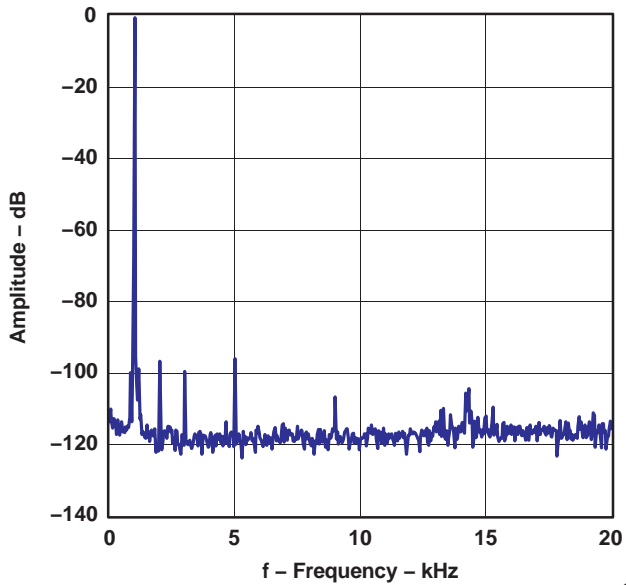

Figure 13.

G013

OUTPUT SPECTRUM (-60 dB, N = 8192)

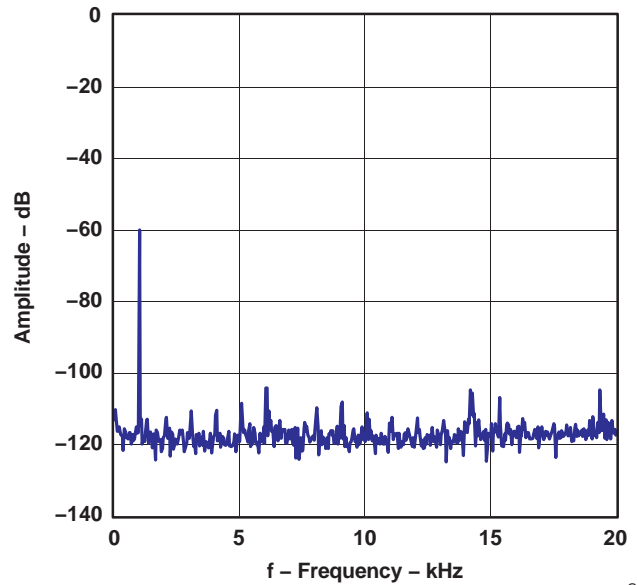

Figure 14.

G014

TYPICAL CHARACTERISTICS (continued)

All specifications at $T_A = 25^\circ\text{C}$, $V_{DD} = V_{CCC} = V_{CCP1} = V_{CCP2} = V_{CCX} = 3.3\text{ V}$, $f_s = 44.1\text{ kHz}$, $f_{IN} = 1\text{ kHz}$, 16-bit data, unless otherwise noted.

DAC OUTPUT SPECTRUM

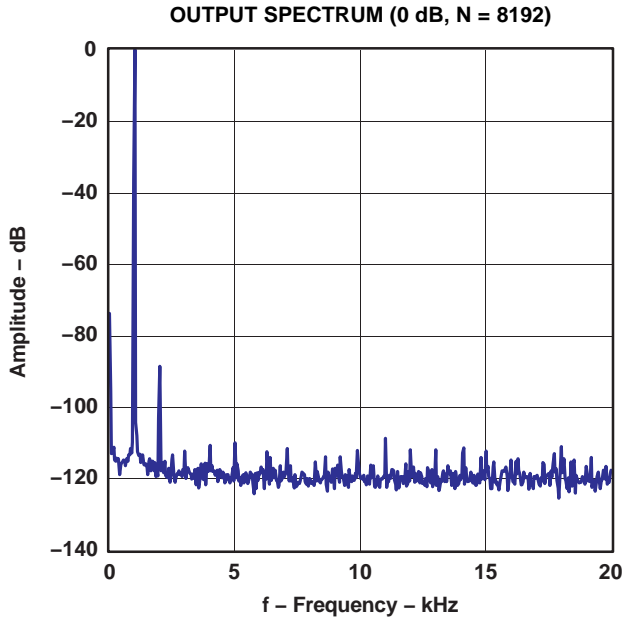

Figure 15.

G015

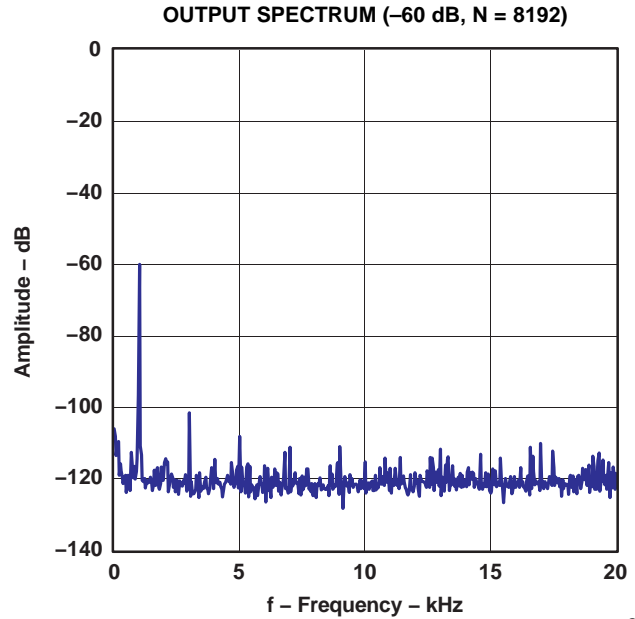

Figure 16.

G016

SUPPLY CURRENT

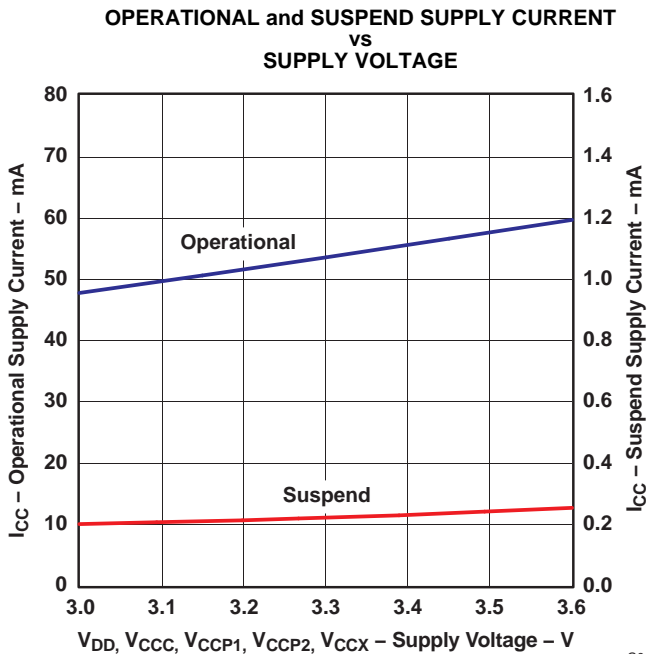

Figure 17.

G017

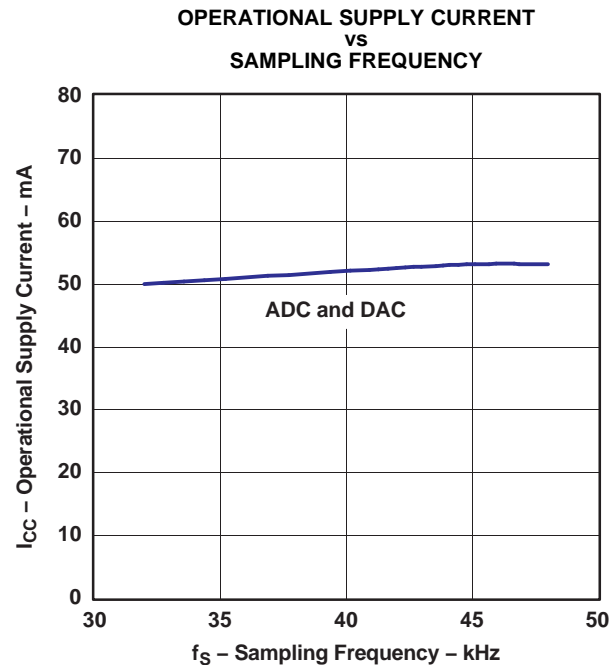

Figure 18.

G018

TYPICAL CHARACTERISTICS (continued)

All specifications at $T_A = 25^\circ\text{C}$, $V_{DD} = V_{CC} = V_{CCP1} = V_{CCP2} = V_{CCX} = 3.3\text{ V}$, $f_s = 44.1\text{ kHz}$, $f_{IN} = 1\text{ kHz}$, 16-bit data, unless otherwise noted.

ADC DIGITAL DECIMATION FILTER FREQUENCY RESPONSE

OVERALL CHARACTERISTICS

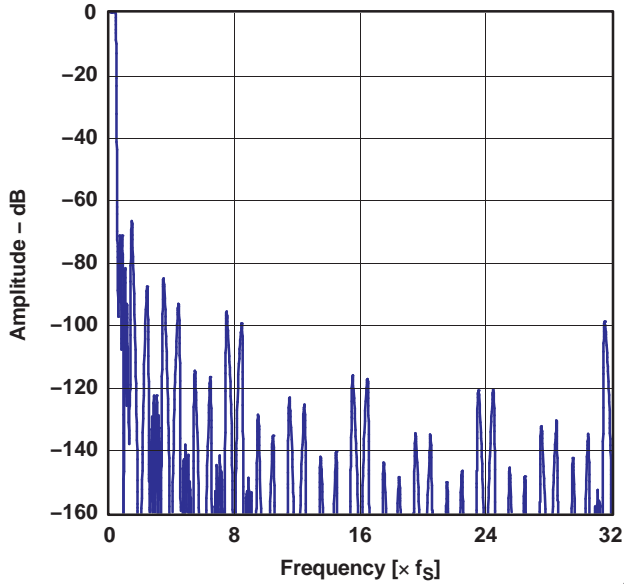

Figure 19.

G019

STOP-BAND ATTENUATION

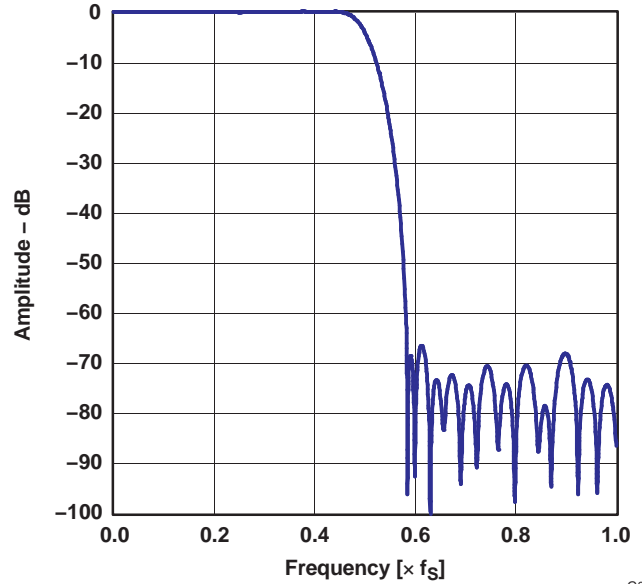

Figure 20.

G020

PASS-BAND RIPPLE

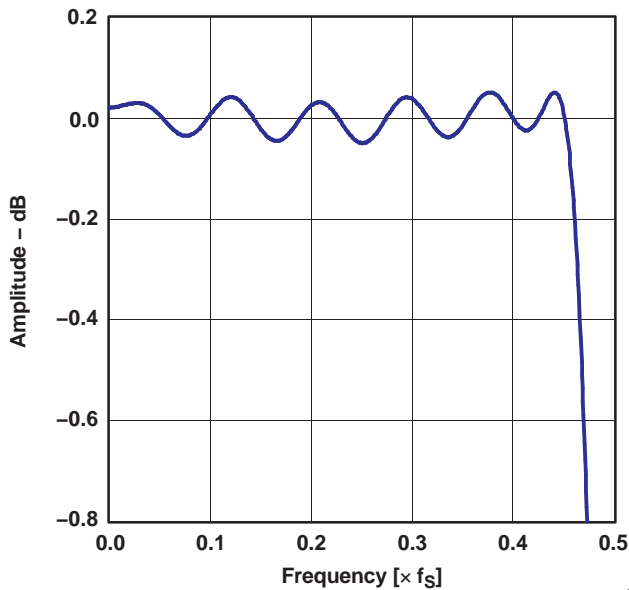

Figure 21.

G021

TRANSITION-BAND RESPONSE

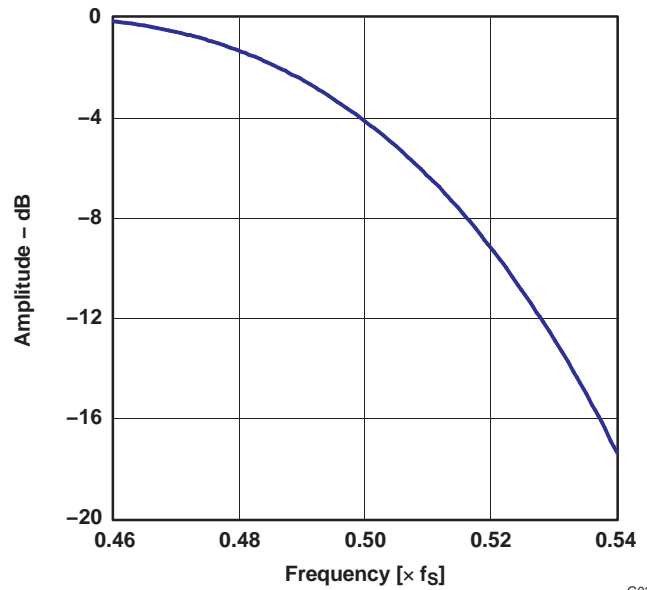

Figure 22.

G022

TYPICAL CHARACTERISTICS (continued)

All specifications at $T_A = 25^\circ\text{C}$, $V_{DD} = V_{CC} = V_{CCP1} = V_{CCP2} = V_{CCX} = 3.3\text{ V}$, $f_s = 44.1\text{ kHz}$, $f_{IN} = 1\text{ kHz}$, 16-bit data, unless otherwise noted.

ADC DIGITAL HIGH-PASS FILTER FREQUENCY RESPONSE

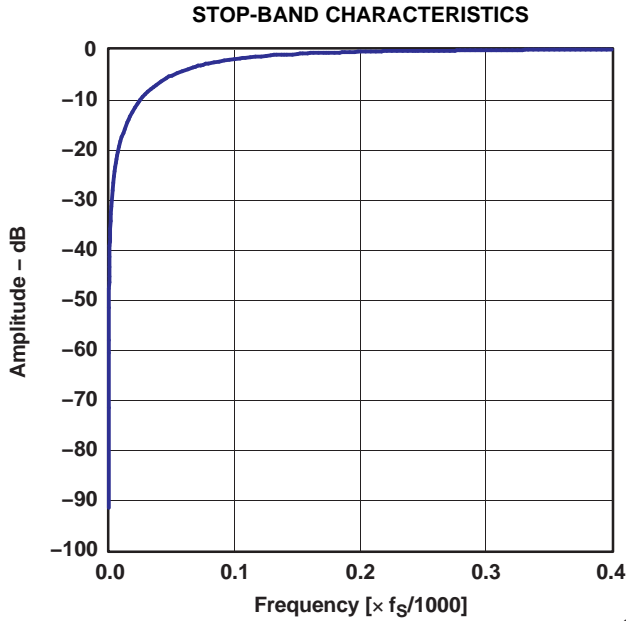

Figure 23.

G023

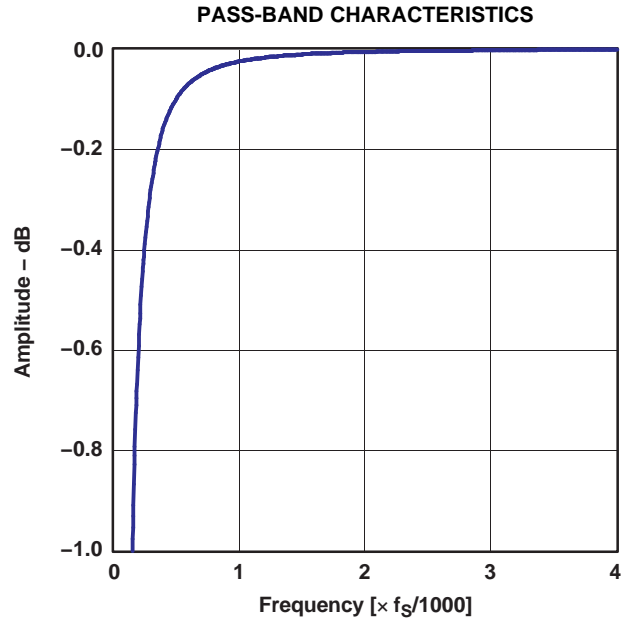

Figure 24.

G024

ADC ANALOG ANTIALIASING FILTER FREQUENCY RESPONSE

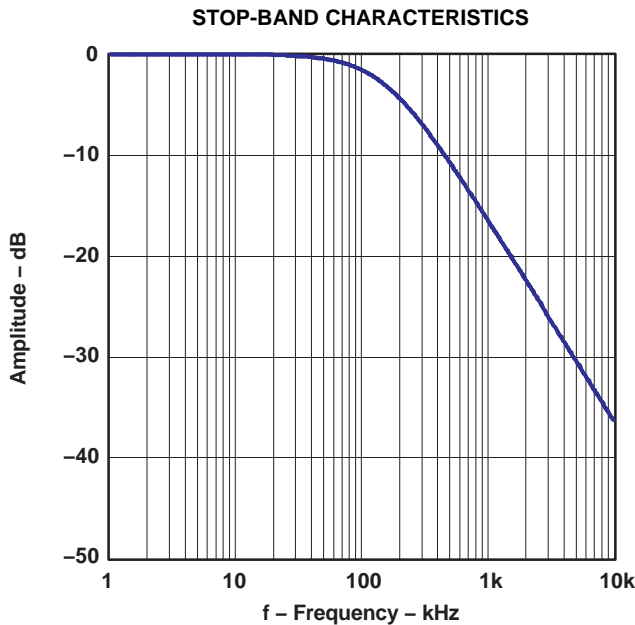

Figure 25.

G025

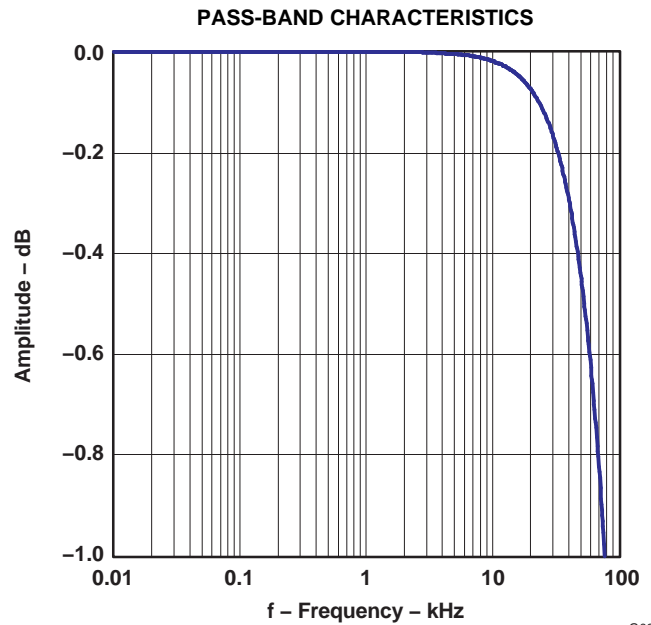

Figure 26.

G026

TYPICAL CHARACTERISTICS (continued)

All specifications at $T_A = 25^\circ\text{C}$, $V_{DD} = V_{CCC} = V_{CCP1} = V_{CCP2} = V_{CCX} = 3.3\text{ V}$, $f_s = 44.1\text{ kHz}$, $f_{IN} = 1\text{ kHz}$, 16-bit data, unless otherwise noted.

DAC DIGITAL INTERPOLATION FILTER FREQUENCY RESPONSE

STOP-BAND ATTENUATION

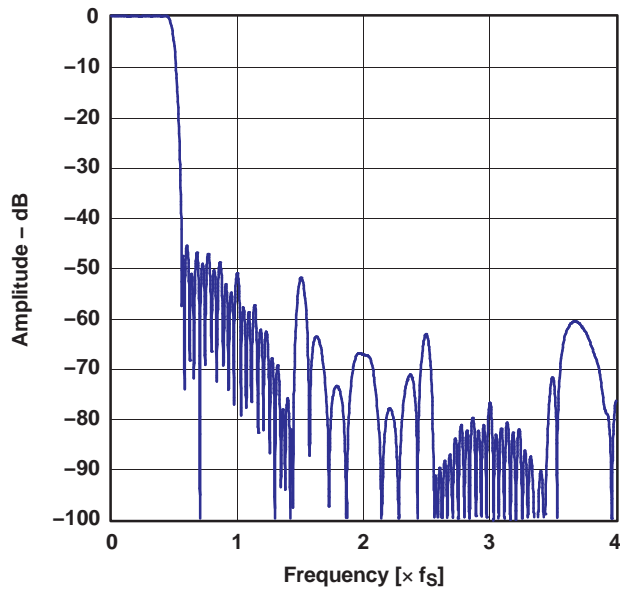

G027

Figure 27.

PASS-BAND RIPPLE

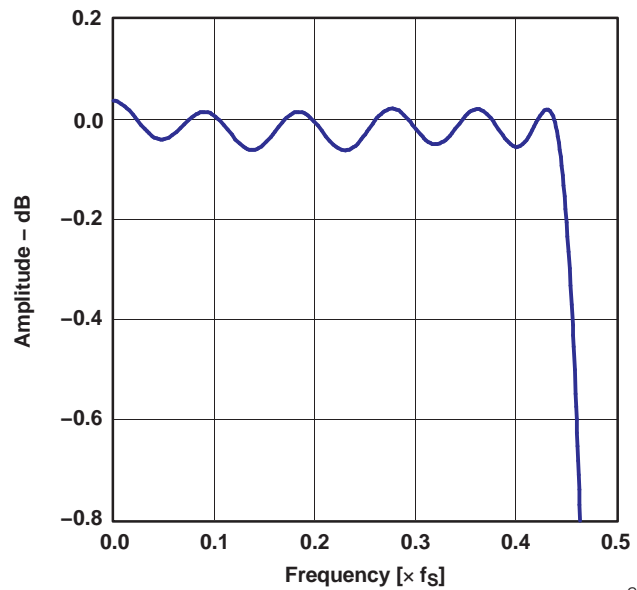

G028

Figure 28.

TRANSITION-BAND RESPONSE

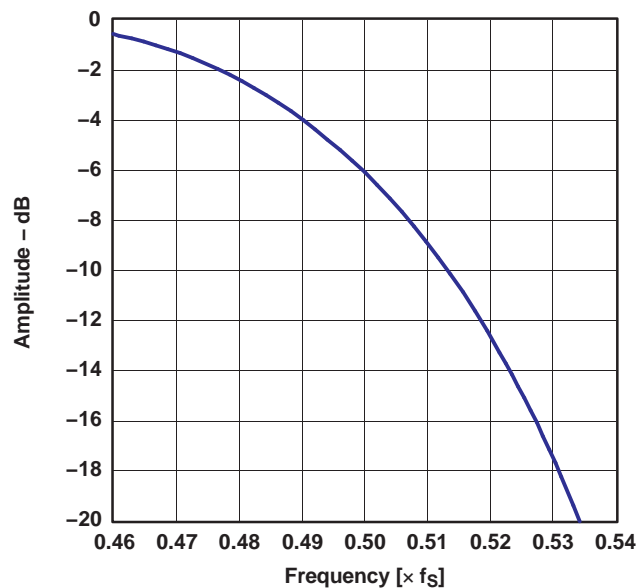

G029

Figure 29.

TYPICAL CHARACTERISTICS (continued)

All specifications at $T_A = 25^\circ\text{C}$, $V_{DD} = V_{CCC} = V_{CCP1} = V_{CCP2} = V_{CCX} = 3.3\text{ V}$, $f_s = 44.1\text{ kHz}$, $f_{IN} = 1\text{ kHz}$, 16-bit data, unless otherwise noted.

DAC ANALOG FIR FILTER FREQUENCY RESPONSE

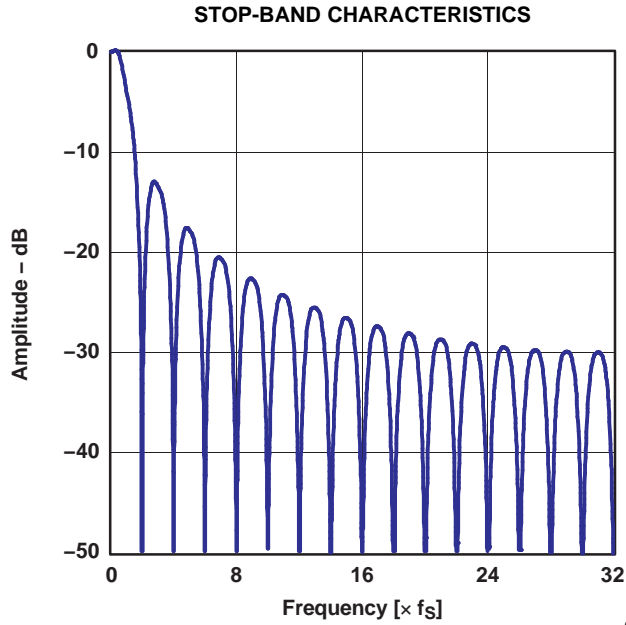

Figure 30.

G030

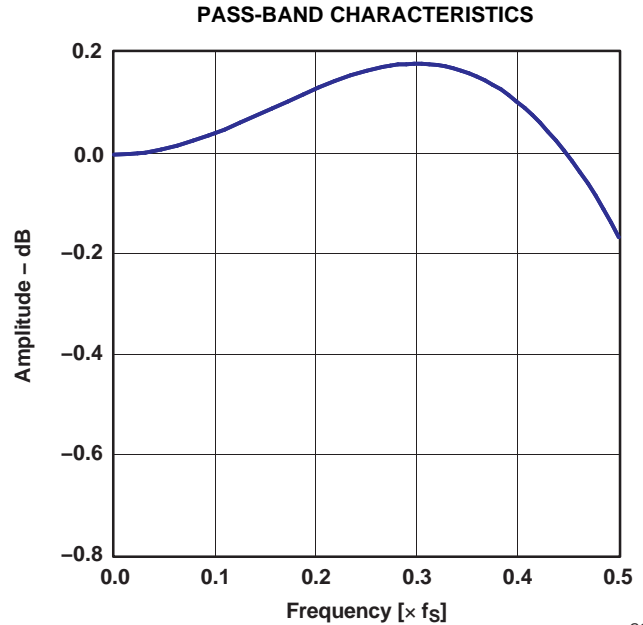

Figure 31.

G031

DAC ANALOG LOW-PASS FILTER FREQUENCY RESPONSE

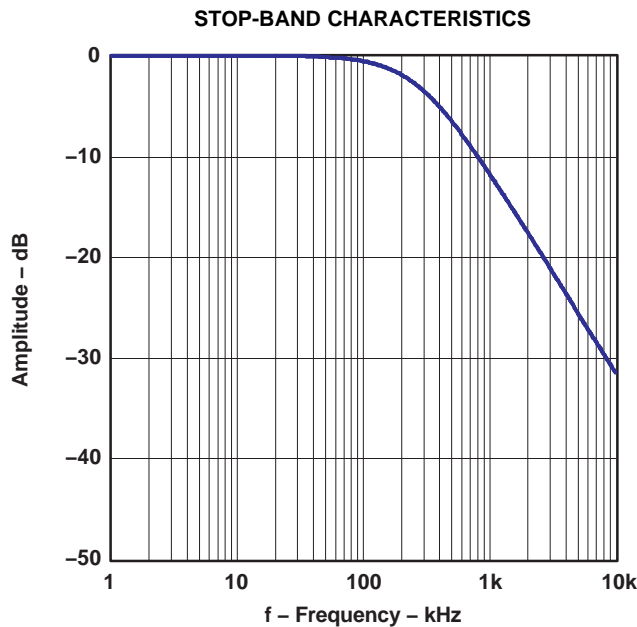

Figure 32.

G032

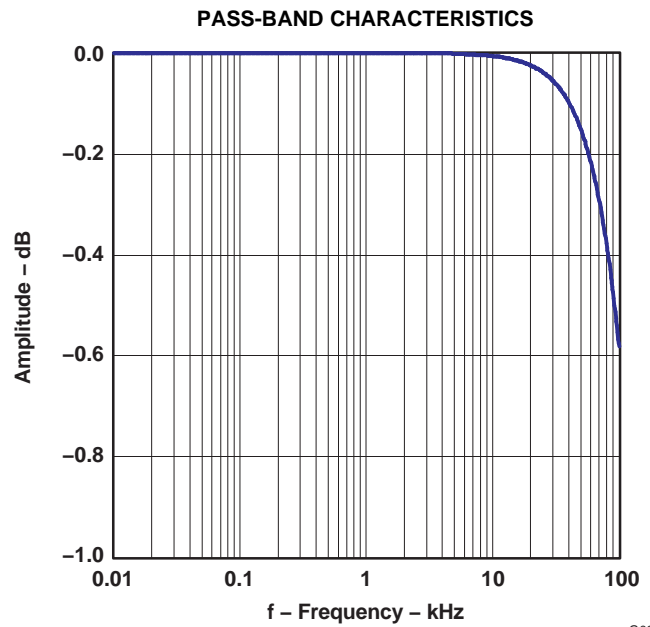

Figure 33.

G033

DETAILED DESCRIPTION

USB INTERFACE

Control data and audio data are transferred to the PCM2901/2903 via D+ (pin 1) and D– (pin 2). All data to/from the PCM2901/2903 is transferred at full speed. The device descriptor contains the information described in Table 1. The device descriptor can be modified on request; contact a Texas Instruments representative for details.

Table 1. Device Descriptor

USB revision	1.1 compliant
Device class	0x00 (device-defined interface level)
Device subclass	0x00 (not specified)
Device protocol	0x00 (not specified)
Max packet size for end-point 0	8 bytes
Vendor ID	0x08BB (default value, can be modified)
Product ID	0x2901 / 0x2903 (default value, can be modified)
Device release number	1.0 (0x0100)
Number of configurations	1
Vendor strings	String #1 (see Table 3)
Product strings	String #2 (see Table 3)
Serial number	Not supported

The configuration descriptor contains the information described in [Table 2](#). The configuration descriptor can be modified on request; contact a Texas Instruments representative for details.

Table 2. Configuration Descriptor

Interface	Four interfaces
Power attribute	0xC0 (Self-powered, no remote wakeup)
Maximum power	0x00 (0 mA. Default value, can be modified)

The string descriptor contains the information described in [Table 3](#). The string descriptor can be modified on request; contact a Texas Instruments representative for details.

Table 3. String Descriptor

#0	0x0409
#1	Burr-Brown from TI (default value, can be modified)
#2	USB audio codec (default value, can be modified)

DEVICE CONFIGURATON

Figure 34 illustrates the USB audio function topology. The PCM2901/2903 has four interfaces. Each interface is constructed by alternative settings.

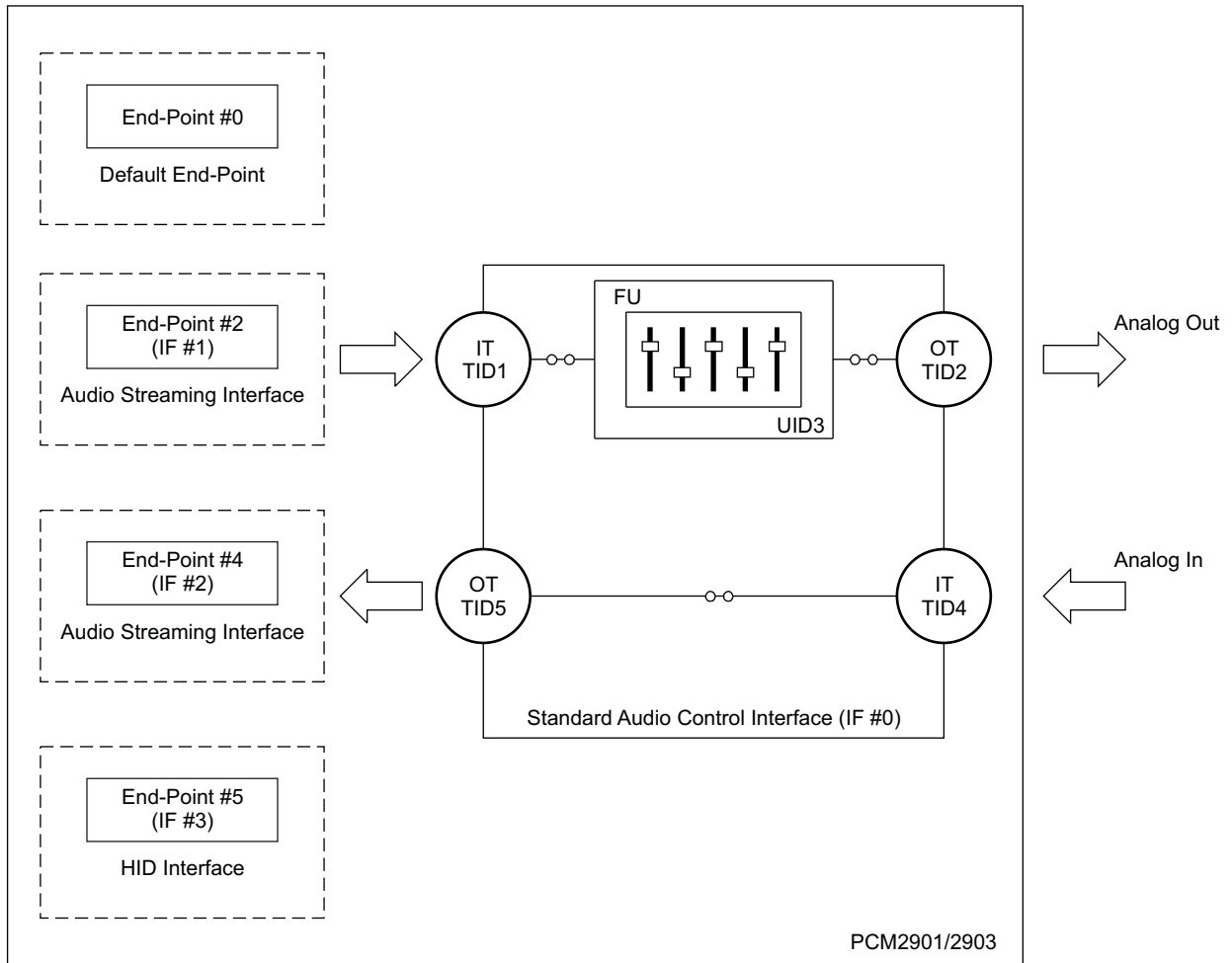

M0024-04

Figure 34. USB Audio Function Topology

Interface #0

Interface #0 is defined as the control interface. Alternative setting #0 is the only possible setting for interface #0. Alternative setting #0 describes the standard audio control interface. A terminal constructs the audio control interface. The PCM2901/2903 has the following five terminals.

- Input terminal (IT #1) for isochronous-out stream
- Output terminal (OT #2) for audio analog output
- Feature unit (FU #3) for DAC digital attenuator
- Input terminal (IT #4) for audio analog input
- Output terminal (OT #5) for isochronous-in stream

Input terminal #1 is defined as USB stream (terminal type 0x0101). Input terminal #1 can accept 2-channel audio streams constructed by left and right channels. Output terminal #2 is defined as a speaker (terminal type 0x0301). Input terminal #4 is defined as microphone (terminal type 0x0201). Output terminal #5 is defined as a USB stream (terminal type 0x0101). Output terminal #5 can generate 2-channel audio streams constructed by left and right channels. Feature unit #3 supports the following sound control features.

- Volume control
- Mute control

The built-in digital volume controller can be manipulated by an audio class specific request from 0 dB to –64 dB in 1-dB steps. Changes are made by incrementing or decrementing by one step (1 dB) for every $1/f_s$ time interval until the volume level has reached the requested value. Each channel can be set for different values. The master volume control is not supported. A request to the master volume is stalled and ignored. The built-in digital mute controller can be manipulated by audio class-specific request. A master mute control request is acceptable. A request to an individual channel is stalled and ignored.

Interface #1

Interface #1 is defined as the audio streaming data-out interface. Interface #1 has the following seven alternative settings. Alternative setting #0 is the zero-bandwidth setting.

ALTERNATIVE SETTING	DATA FORMAT			TRANSFER MODE	SAMPLING RATE (kHz)
00	Zero bandwidth				
01	16 bit	Stereo	2s complement (PCM)	Adaptive	32, 44.1, 48
02	16 bit	Mono	2s complement (PCM)	Adaptive	32, 44.1, 48
03	8 bit	Stereo	2s complement (PCM)	Adaptive	32, 44.1, 48
04	8 bit	Mono	2s complement (PCM)	Adaptive	32, 44.1, 48
05	8 bit	Stereo	Offset binary (PCM8)	Adaptive	32, 44.1, 48
06	8 bit	Mono	Offset binary (PCM8)	Adaptive	32, 44.1, 48

Interface #2

Interface #2 is defined as the audio streaming data-in interface. Interface #2 has the following 19 alternative settings. Alternative setting #0 is the zero-bandwidth setting. All other alternative settings are operational settings.

ALTERNATIVE SETTING	DATA FORMAT			TRANSFER MODE	SAMPLING RATE (kHz)
00	Zero bandwidth				
01	16 bit	Stereo	2s complement (PCM)	Asynchronous	48
02	16 bit	Mono	2s complement (PCM)	Asynchronous	48
03	16 bit	Stereo	2s complement (PCM)	Asynchronous	44.1
04	16 bit	Mono	2s complement (PCM)	Asynchronous	44.1
05	16 bit	Stereo	2s complement (PCM)	Asynchronous	32
06	16 bit	Mono	2s complement (PCM)	Asynchronous	32
07	16 bit	Stereo	2s complement (PCM)	Asynchronous	22.05
08	16 bit	Mono	2s complement (PCM)	Asynchronous	22.05
09	16 bit	Stereo	2s complement (PCM)	Asynchronous	16
0A	16 bit	Mono	2s complement (PCM)	Asynchronous	16
0B	8 bit	Stereo	2s complement (PCM)	Asynchronous	16
0C	8 bit	Mono	2s complement (PCM)	Asynchronous	16
0D	8 bit	Stereo	2s complement (PCM)	Asynchronous	8
0E	8 bit	Mono	2s complement (PCM)	Asynchronous	8
0F	16 bit	Stereo	2s complement (PCM)	Synchronous	11.025
10	16 bit	Mono	2s complement (PCM)	Synchronous	11.025
11	8 bit	Stereo	2s complement (PCM)	Synchronous	11.025
12	8 bit	Mono	2s complement (PCM)	Synchronous	11.025

Interface #3

Interface #3 is defined as the interrupt data-in interface. Alternative setting #0 is the only possible setting for interface #3. Interface #3 constructs the HID consumer control device. Interface #3 reports the following three key statuses.

- Mute (0xE209)
- Volume up (0xE909)
- Volume down (0xEA09)

End-Points

The PCM2901/2903 has the following four end-points.

- Control end-point (EP #0)
- Isochronous-out audio data stream end-point (EP #2)
- Isochronous-in audio data stream end-point (EP #4)
- HID end-point (EP #5)

The control end-point is a default end-point. The control end-point is used to control all functions of the PCM2901/2903 by the standard USB request and USB audio-class-specific request from the host. The isochronous-out audio data stream end-point is an audio sink end-point, which receives the PCM audio data. The isochronous-out audio data stream end-point accepts the adaptive transfer mode. The isochronous-in audio data stream end-point is an audio source end-point, which transmits the PCM audio data. The isochronous-in audio data stream end-point uses asynchronous transfer mode. The HID end-point is an interrupt-in end-point. HID end-point reports HID0, HID1, and HID2 pin status every 32 ms.

The human interface device (HID) pins are defined as consumer control devices. The HID function is designed as an independent end-point from both isochronous-in and -out end-points. This means that the device affected by the HID operation depends on the host software. Typically, the HID function affects the primary audio-out device.

Clock and Reset

The PCM2901/2903 requires a 12-MHz (± 500 ppm) clock for the USB and audio function, which can be generated by a built-in crystal oscillator with a 12-MHz crystal resonator or supplied by an external clock. The 12-MHz crystal resonator must be connected to XTI (pin 21) and XTO (pin 20) with one high (1-M Ω) resistor and two small capacitors, the capacitance of which depends on the load capacitance of the crystal resonator. If the external clock is used, the clock must be supplied to XTI, and XTO must be open.

The PCM2901/2903 has an internal power-on reset circuit, which works automatically when V_{DD} (pin 27) exceeds 2.5 V typical (2.7 V to 2.2 V), and about 700 μ s is required until internal reset release.)

Digital Audio Interface (PCM2903)

The PCM2903 employs both S/PDIF input and output. Isochronous-out data from the host is encoded to the S/PDIF output and the DAC analog output. Input data is selected as either S/PDIF or ADC analog input. When the device detects an S/PDIF input and successfully locks on the received data, the isochronous-in transfer data source is automatically selected from S/PDIF itself; otherwise, the data source is selected to ADC analog input.

Supported Input Data (PCM2903)

The following data formats are accepted by the S/PDIF input and output. All other data formats are unable to use S/PDIF.

- 48-kHz 16-bit stereo
- 44.1-kHz 16-bit stereo
- 32-kHz 16-bit stereo

Mismatch between input data format and host command may cause unexpected results except in the following conditions.

- Record monaural format from stereo data input at the same data rate
- Record 8-bit format from 16-bit data input at the same data rate

A combination of the foregoing conditions is not accepted.

For playback, all possible data-rate source is converted to 16-bit stereo format at the same source data rate.

Channel Status Information (PCM2903)

The channel status information is fixed as consumer application, PCM mode, copyright, and digital/digital converter. All other bits are fixed as 0s except for the sample frequency, which is set automatically according to the data received through the USB.

Copyright Management (PCM2903)

Isochronous-in data is affected by the serial copy management system (SCMS). Where receiving digital audio data that is indicated as original data in the control bit, input digital audio data transfers to the host. If the data is indicated as first generation or higher, transferred data is selected to analog input.

Digital audio data output is always encoded as original with SCMS control.

The implementation of this feature is an option for the customer. Note that it is the user's responsibility whether they implement this feature in their product or not.

INTERFACE SEQUENCE

Power On, Attach, and Playback Sequence

The PCM2901/2903 is ready for setup when the reset sequence has finished and the USB bus is attached. In order to perform certain reset sequences defined in the USB specification, V_{DD} , V_{CC} , V_{CCP1} , V_{CCP2} , and V_{CCX} must rise up with 10 ms / 3.3 V. After connection has been established by setup, the PCM2901/2903 is ready to accept USB audio data. While waiting, the audio data (idle state) and analog output are set to bipolar zero (BPZ).

When receiving the audio data, the PCM2901/2903 stores the first audio packet, which contained 1-ms audio data, into the internal storage buffer. The PCM2901/2903 starts playing the audio data when detecting the following start of frame (SOF) packet.

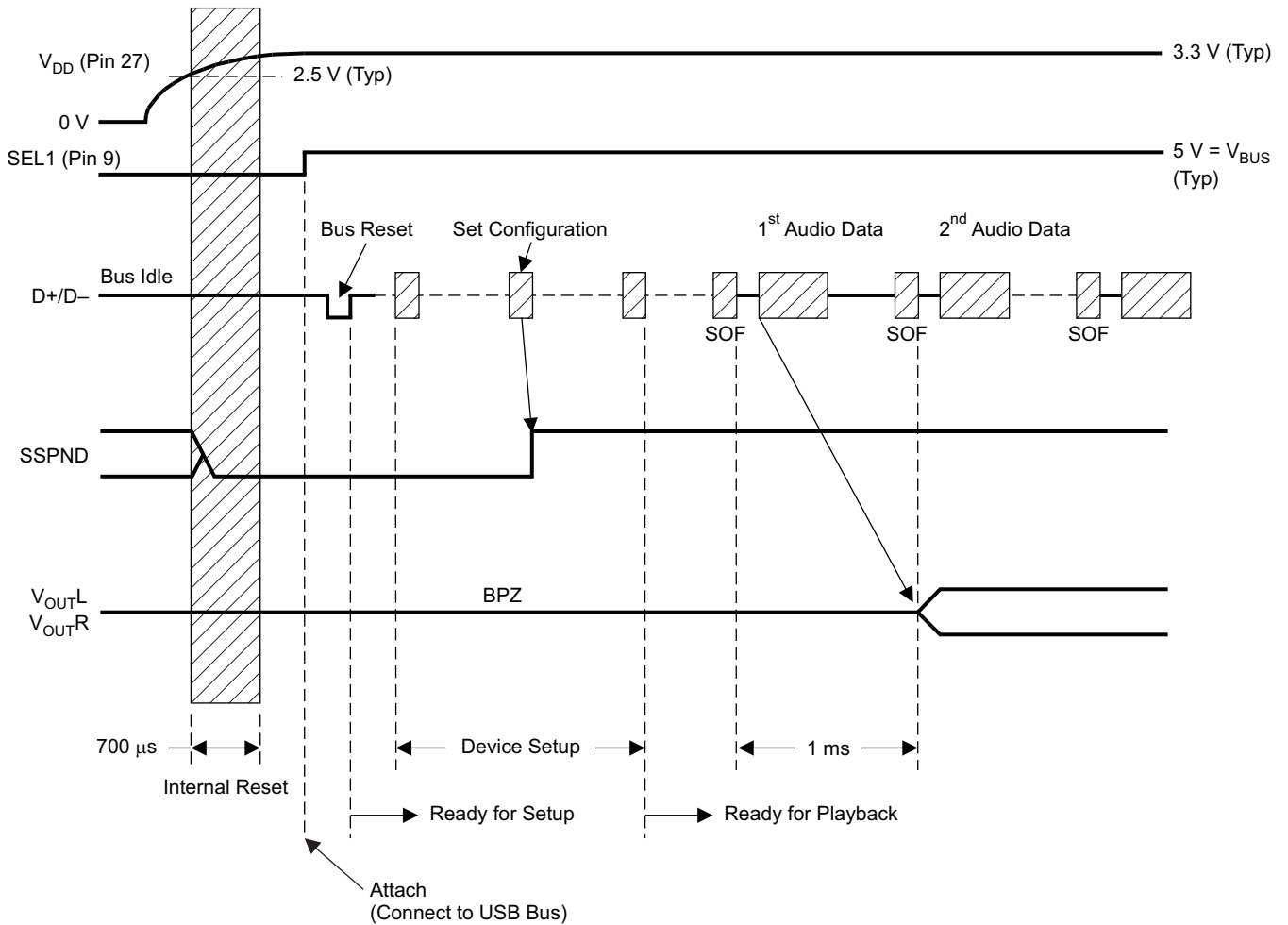

T0055-03

Figure 35. Attach After Power On

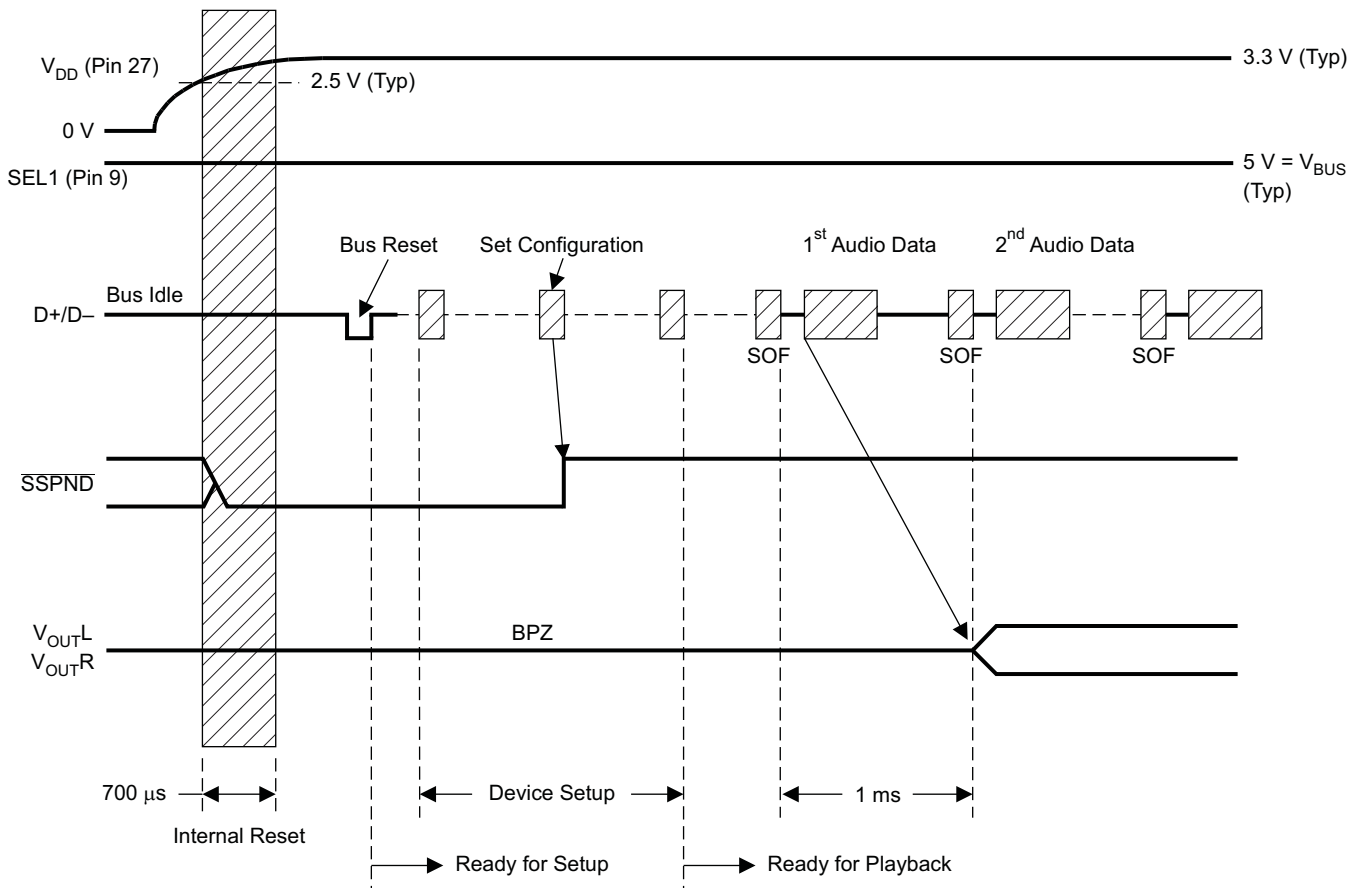

T0273-01

Figure 36. Power-On Under Attach

Play, Stop, and Detach Sequence

When the host finishes or aborts the playback, the PCM2901/2903 stops playing after the last audio data has played.

Record Sequence

The PCM2901/2903 starts the audio capture into the internal memory after receiving the SET_INTERFACE command.

Suspend and Resume Sequence

The PCM2901/2903 enters the suspend state after it detects a constant idle state on the USB bus, approximately 5 ms. While the PCM2901/2903 enters the suspend state, the SSPND flag (pin 28) is asserted. The PCM2901/2903 wakes up immediately after detecting a non-idle state on the USB bus.

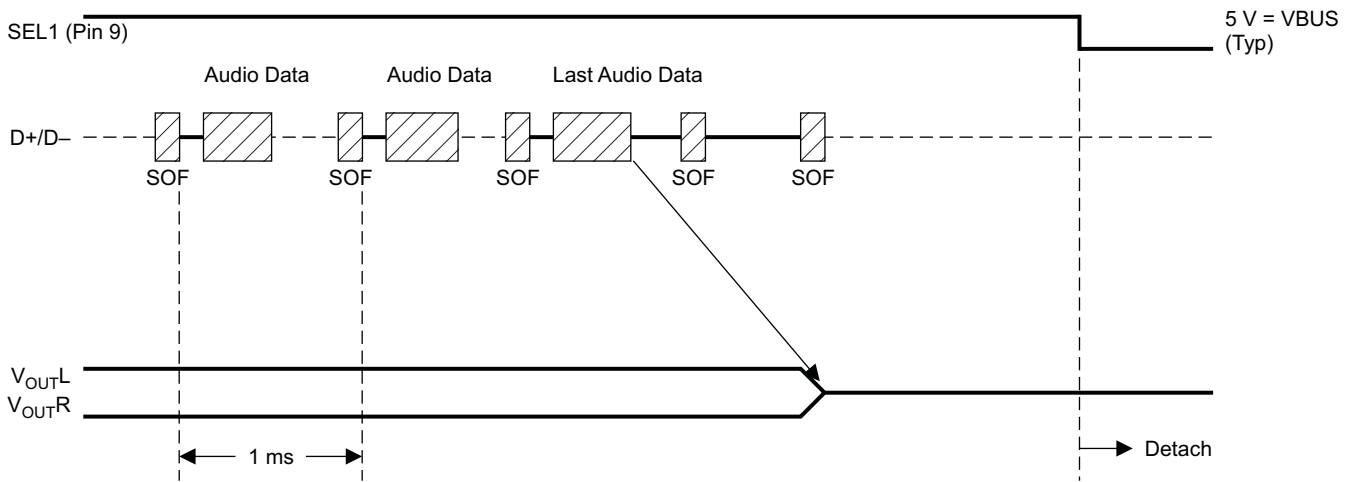

T0056-03

Figure 37. Play, Stop, and Detach

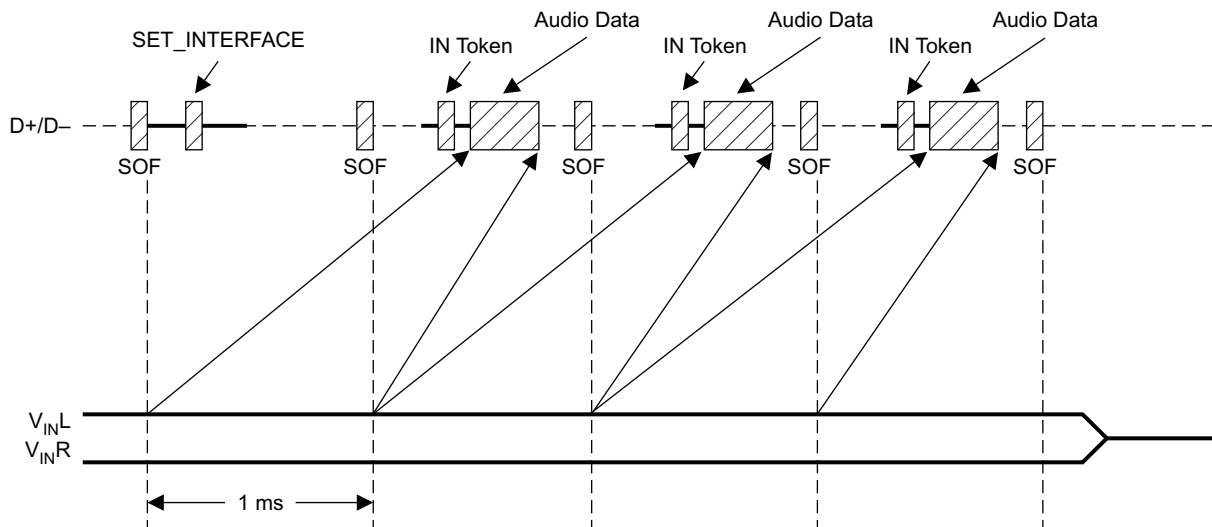

T0259-01

Figure 38. Record Sequence

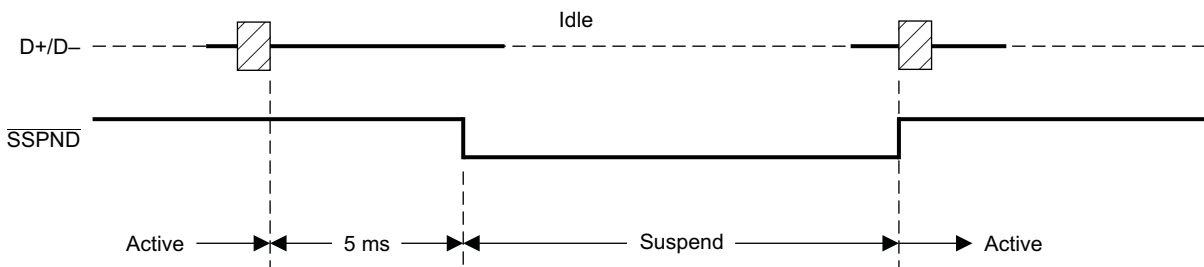

T0057-02

Figure 39. Suspend and Resume

PCM2901 TYPICAL CIRCUIT CONNECTION

Figure 40 illustrates a typical circuit connection for a simple application. The circuit illustrated is for information only. The whole board design should be considered to meet the USB specification as a USB-compliant product.

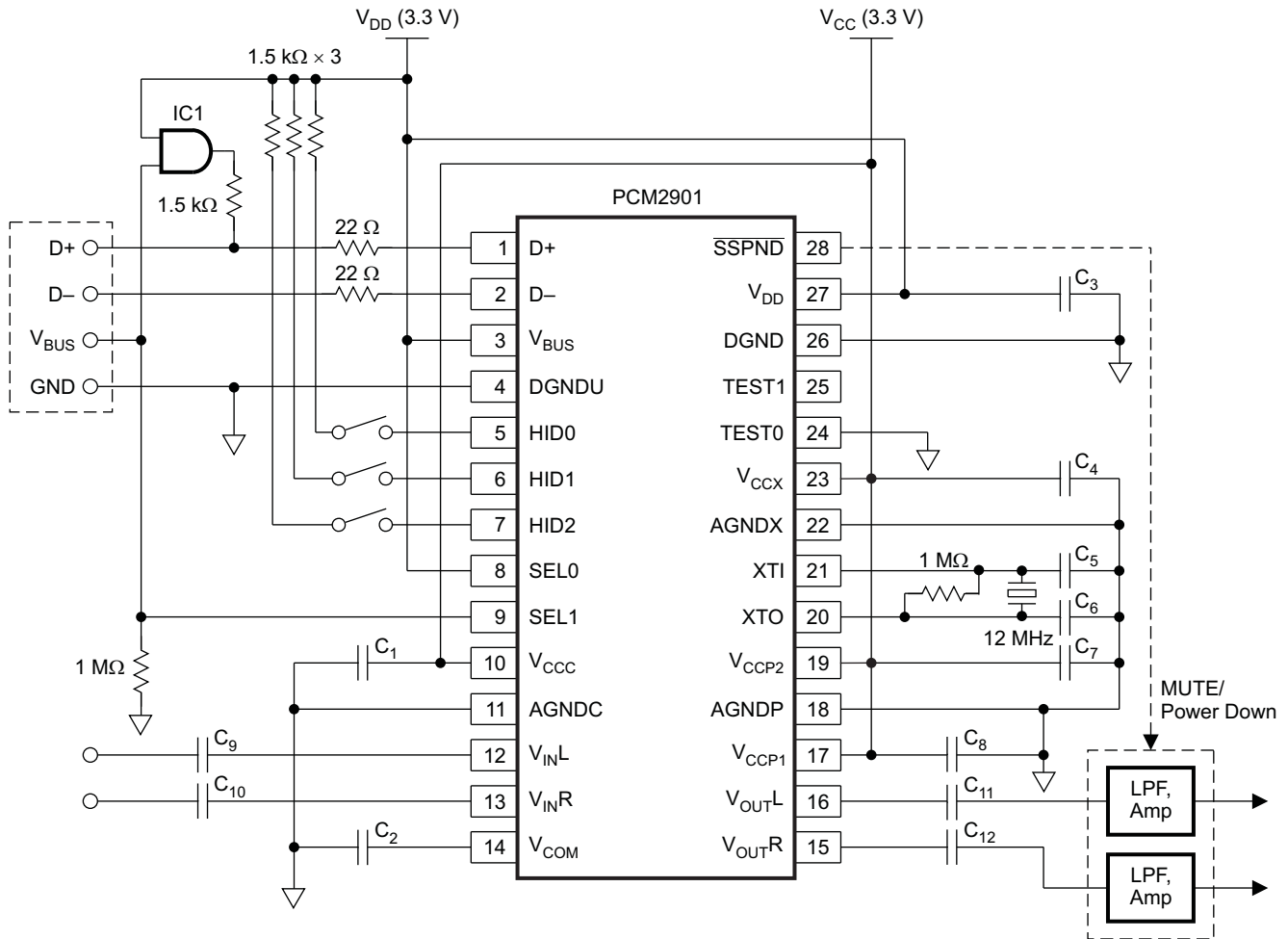

S0312-01

NOTE:

- IC1 must be driven by V_{DD} with a 5-V tolerant input.
- C₁, C₂, C₃, C₄, C₇, C₈: 10 μF
- C₅, C₆: 10 pF to 33 pF (depending on crystal resonator)
- C₉, C₁₀, C₁₁, C₁₂: The capacitance may vary depending on design.

Figure 40. Self-Powered Configuration

PCM2903 TYPICAL CIRCUIT CONNECTION

Figure 41 illustrates a typical circuit connection for a simple application. The circuit illustrated is for information only. The whole board design should be considered to meet the USB specification as a USB-compliant product.

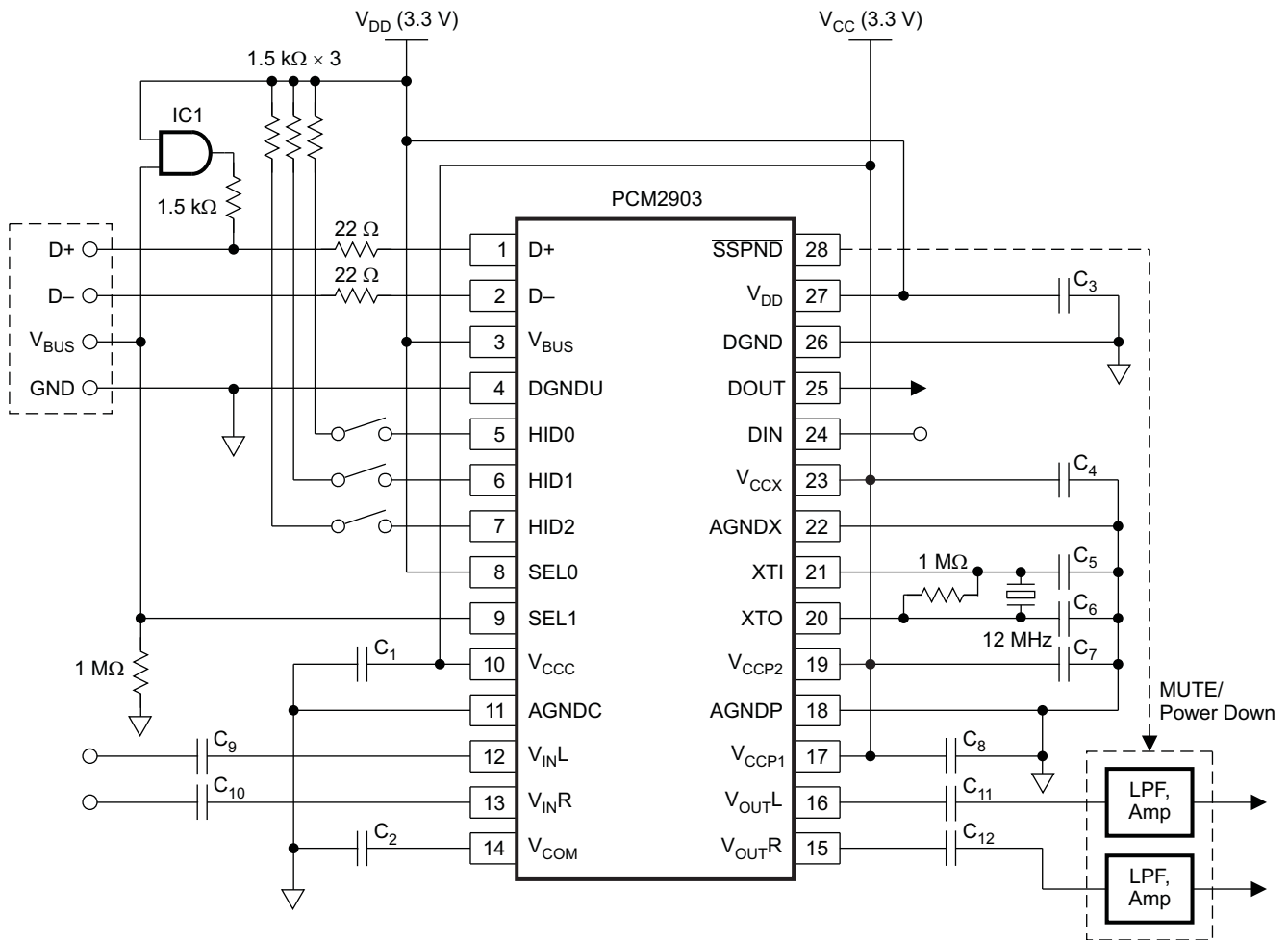

S0312-02

NOTE:

- IC1 must be driven by V_{DD} with a 5-V tolerant input.
- $C_1, C_2, C_3, C_4, C_7, C_8$: 10 μ F
- C_5, C_6 : 10 pF to 33 pF (depending on crystal resonator)
- $C_9, C_{10}, C_{11}, C_{12}$: The capacitance may vary depending on design.

Figure 41. Self-Powered Configuration

APPENDIX

Operating Environment

For current information on the PCM2901/2903 operating environment, see the *Updated Operating Environments for PCM270X, PCM290X Applications* application report, [SLAA374](#).

REVISION HISTORY

Changes from Revision B (March 2002) to Revision C	Page
• Deleted operating environment information from data sheet and added reference to application report	30

PACKAGING INFORMATION

Orderable Device	Status (1)	Package Type	Package Drawing	Pins	Package Qty	Eco Plan (2)	Lead/Ball Finish (6)	MSL Peak Temp (3)	Op Temp (°C)	Device Marking (4/5)	Samples
PCM2901E	ACTIVE	SSOP	DB	28	47	Green (RoHS & no Sb/Br)	CU NIPDAU	Level-1-260C-UNLIM	0 to 70	PCM2901E	Samples
PCM2901E/2K	ACTIVE	SSOP	DB	28	2000	Green (RoHS & no Sb/Br)	CU NIPDAU	Level-1-260C-UNLIM	0 to 70	PCM2901E	Samples
PCM2901EG4	ACTIVE	SSOP	DB	28	47	Green (RoHS & no Sb/Br)	CU NIPDAU	Level-1-260C-UNLIM	0 to 70	PCM2901E	Samples
PCM2903E	NRND	SSOP	DB	28	47	Green (RoHS & no Sb/Br)	CU NIPDAU	Level-1-260C-UNLIM	0 to 70	PCM2903E	

(1) The marketing status values are defined as follows:

ACTIVE: Product device recommended for new designs.

LIFEBUY: TI has announced that the device will be discontinued, and a lifetime-buy period is in effect.

NRND: Not recommended for new designs. Device is in production to support existing customers, but TI does not recommend using this part in a new design.

PREVIEW: Device has been announced but is not in production. Samples may or may not be available.

OBSELETE: TI has discontinued the production of the device.

(2) Eco Plan - The planned eco-friendly classification: Pb-Free (RoHS), Pb-Free (RoHS Exempt), or Green (RoHS & no Sb/Br) - please check <http://www.ti.com/productcontent> for the latest availability information and additional product content details.

TBD: The Pb-Free/Green conversion plan has not been defined.

Pb-Free (RoHS): TI's terms "Lead-Free" or "Pb-Free" mean semiconductor products that are compatible with the current RoHS requirements for all 6 substances, including the requirement that lead not exceed 0.1% by weight in homogeneous materials. Where designed to be soldered at high temperatures, TI Pb-Free products are suitable for use in specified lead-free processes.

Pb-Free (RoHS Exempt): This component has a RoHS exemption for either 1) lead-based flip-chip solder bumps used between the die and package, or 2) lead-based die adhesive used between the die and leadframe. The component is otherwise considered Pb-Free (RoHS compatible) as defined above.

Green (RoHS & no Sb/Br): TI defines "Green" to mean Pb-Free (RoHS compatible), and free of Bromine (Br) and Antimony (Sb) based flame retardants (Br or Sb do not exceed 0.1% by weight in homogeneous material)

(3) MSL, Peak Temp. - The Moisture Sensitivity Level rating according to the JEDEC industry standard classifications, and peak solder temperature.

(4) There may be additional marking, which relates to the logo, the lot trace code information, or the environmental category on the device.

(5) Multiple Device Markings will be inside parentheses. Only one Device Marking contained in parentheses and separated by a "~" will appear on a device. If a line is indented then it is a continuation of the previous line and the two combined represent the entire Device Marking for that device.

(6) Lead/Ball Finish - Orderable Devices may have multiple material finish options. Finish options are separated by a vertical ruled line. Lead/Ball Finish values may wrap to two lines if the finish value exceeds the maximum column width.

Important Information and Disclaimer: The information provided on this page represents TI's knowledge and belief as of the date that it is provided. TI bases its knowledge and belief on information provided by third parties, and makes no representation or warranty as to the accuracy of such information. Efforts are underway to better integrate information from third parties. TI has taken and continues to take reasonable steps to provide representative and accurate information but may not have conducted destructive testing or chemical analysis on incoming materials and chemicals. TI and TI suppliers consider certain information to be proprietary, and thus CAS numbers and other limited information may not be available for release.

In no event shall TI's liability arising out of such information exceed the total purchase price of the TI part(s) at issue in this document sold by TI to Customer on an annual basis.

TAPE AND REEL INFORMATION



QUADRANT ASSIGNMENTS FOR PIN 1 ORIENTATION IN TAPE



*All dimensions are nominal

Device	Package Type	Package Drawing	Pins	SPQ	Reel Diameter (mm)	Reel Width W1 (mm)	A0 (mm)	B0 (mm)	K0 (mm)	P1 (mm)	W (mm)	Pin1 Quadrant
PCM2901E/2K	SSOP	DB	28	2000	330.0	17.4	8.5	10.8	2.4	12.0	16.0	Q1

TAPE AND REEL BOX DIMENSIONS



*All dimensions are nominal

Device	Package Type	Package Drawing	Pins	SPQ	Length (mm)	Width (mm)	Height (mm)
PCM2901E/2K	SSOP	DB	28	2000	336.6	336.6	28.6

DB0028A



PACKAGE OUTLINE

SSOP - 2 mm max height

SMALL OUTLINE PACKAGE

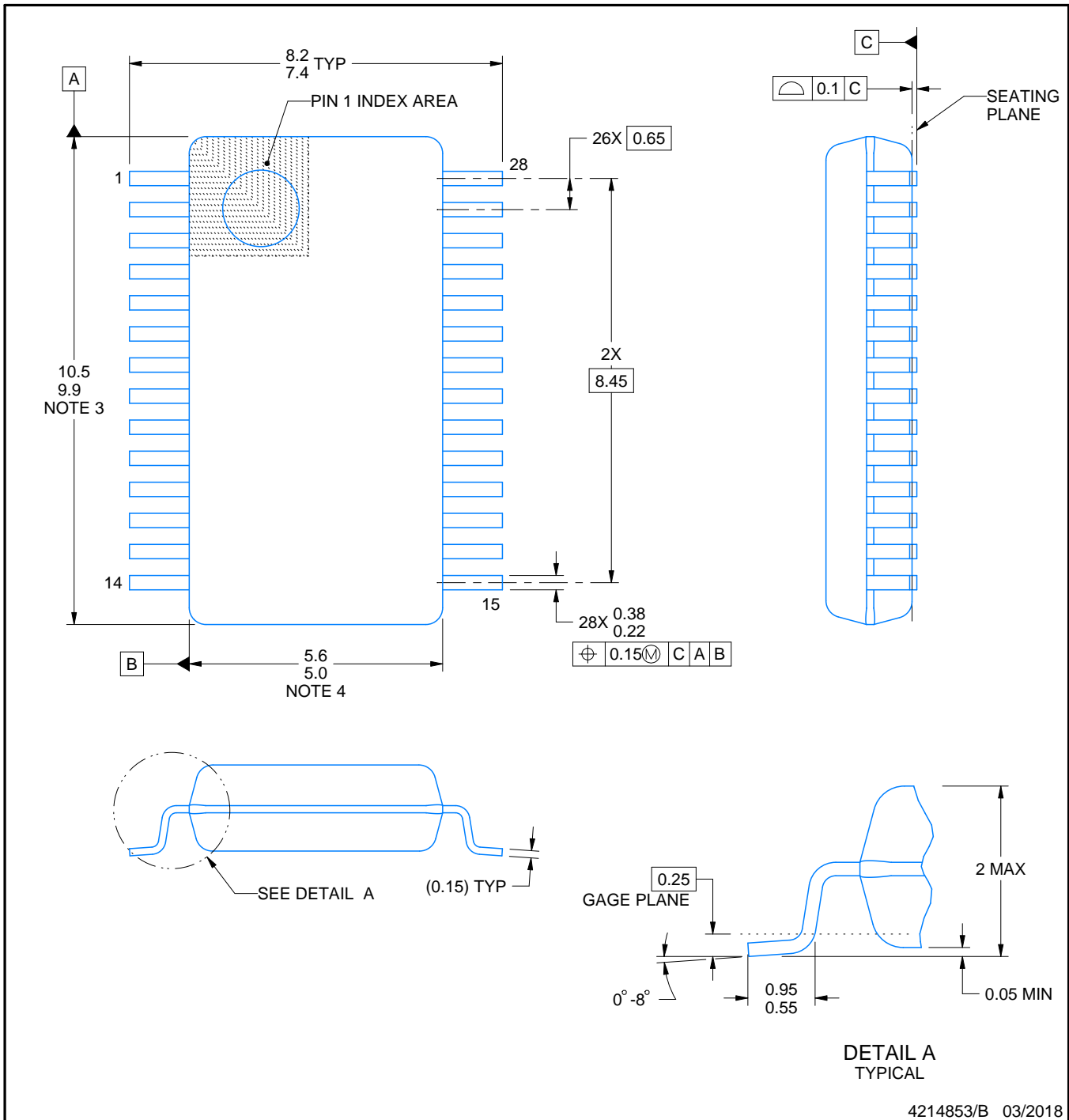

4214853/B 03/2018

NOTES:

1. All linear dimensions are in millimeters. Any dimensions in parenthesis are for reference only. Dimensioning and tolerancing per ASME Y14.5M.
2. This drawing is subject to change without notice.
3. This dimension does not include mold flash, protrusions, or gate burrs. Mold flash, protrusions, or gate burrs shall not exceed 0.15 mm per side.
4. This dimension does not include interlead flash. Interlead flash shall not exceed 0.25 mm per side.
5. Reference JEDEC registration MO-150.

EXAMPLE BOARD LAYOUT

DB0028A

SSOP - 2 mm max height

SMALL OUTLINE PACKAGE

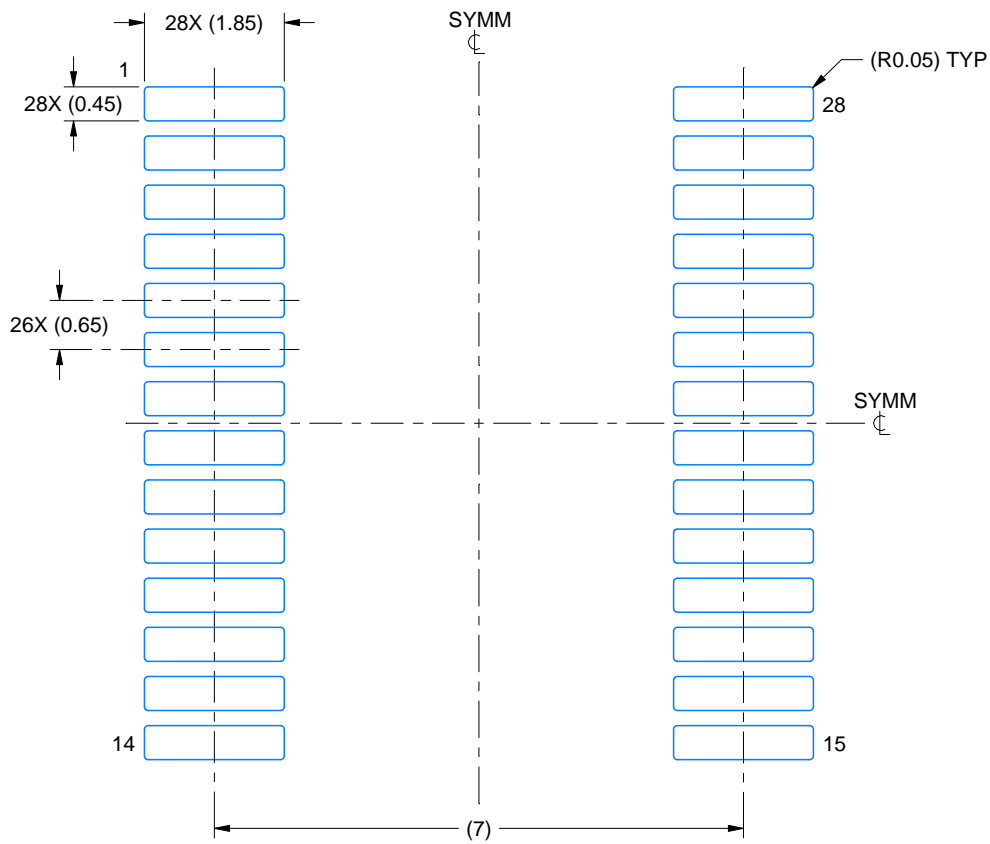

LAND PATTERN EXAMPLE
EXPOSED METAL SHOWN
SCALE: 10X

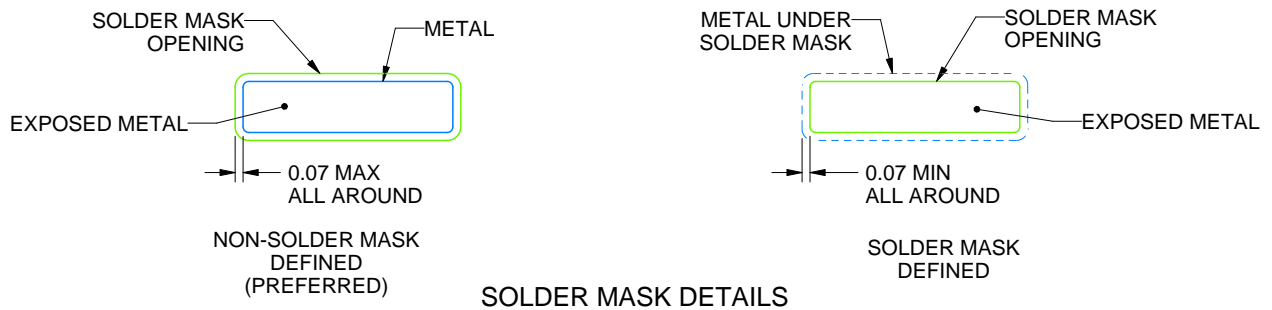

4214853/B 03/2018

NOTES: (continued)

- 6. Publication IPC-7351 may have alternate designs.
- 7. Solder mask tolerances between and around signal pads can vary based on board fabrication site.

EXAMPLE STENCIL DESIGN

DB0028A

SSOP - 2 mm max height

SMALL OUTLINE PACKAGE

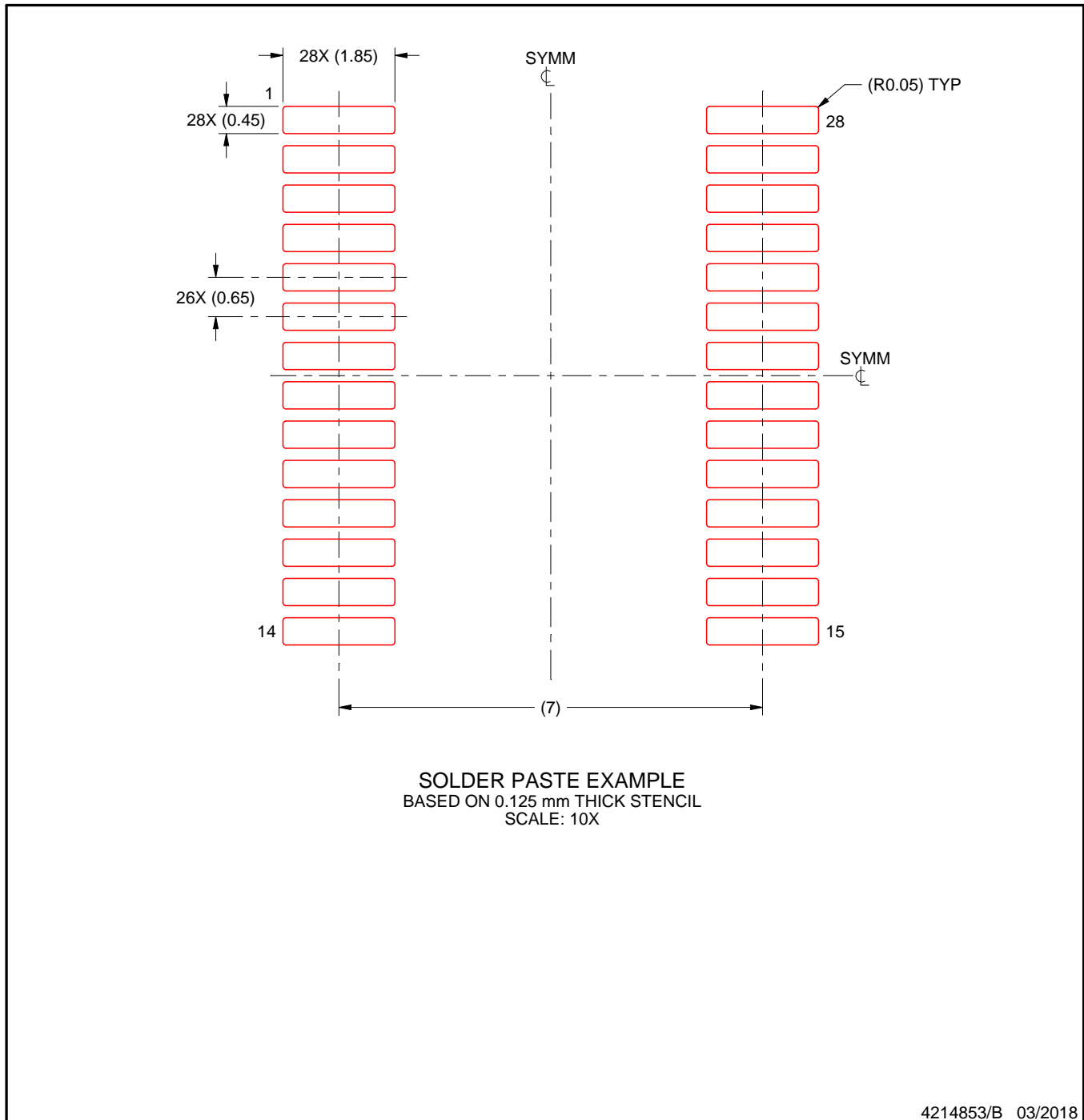

NOTES: (continued)

8. Laser cutting apertures with trapezoidal walls and rounded corners may offer better paste release. IPC-7525 may have alternate design recommendations.
9. Board assembly site may have different recommendations for stencil design.

IMPORTANT NOTICE

Texas Instruments Incorporated (TI) reserves the right to make corrections, enhancements, improvements and other changes to its semiconductor products and services per JESD46, latest issue, and to discontinue any product or service per JESD48, latest issue. Buyers should obtain the latest relevant information before placing orders and should verify that such information is current and complete.

TI's published terms of sale for semiconductor products (<http://www.ti.com/sc/docs/stdterms.htm>) apply to the sale of packaged integrated circuit products that TI has qualified and released to market. Additional terms may apply to the use or sale of other types of TI products and services.

Reproduction of significant portions of TI information in TI data sheets is permissible only if reproduction is without alteration and is accompanied by all associated warranties, conditions, limitations, and notices. TI is not responsible or liable for such reproduced documentation. Information of third parties may be subject to additional restrictions. Resale of TI products or services with statements different from or beyond the parameters stated by TI for that product or service voids all express and any implied warranties for the associated TI product or service and is an unfair and deceptive business practice. TI is not responsible or liable for any such statements.

Buyers and others who are developing systems that incorporate TI products (collectively, "Designers") understand and agree that Designers remain responsible for using their independent analysis, evaluation and judgment in designing their applications and that Designers have full and exclusive responsibility to assure the safety of Designers' applications and compliance of their applications (and of all TI products used in or for Designers' applications) with all applicable regulations, laws and other applicable requirements. Designer represents that, with respect to their applications, Designer has all the necessary expertise to create and implement safeguards that (1) anticipate dangerous consequences of failures, (2) monitor failures and their consequences, and (3) lessen the likelihood of failures that might cause harm and take appropriate actions. Designer agrees that prior to using or distributing any applications that include TI products, Designer will thoroughly test such applications and the functionality of such TI products as used in such applications.

TI's provision of technical, application or other design advice, quality characterization, reliability data or other services or information, including, but not limited to, reference designs and materials relating to evaluation modules, (collectively, "TI Resources") are intended to assist designers who are developing applications that incorporate TI products; by downloading, accessing or using TI Resources in any way, Designer (individually or, if Designer is acting on behalf of a company, Designer's company) agrees to use any particular TI Resource solely for this purpose and subject to the terms of this Notice.

TI's provision of TI Resources does not expand or otherwise alter TI's applicable published warranties or warranty disclaimers for TI products, and no additional obligations or liabilities arise from TI providing such TI Resources. TI reserves the right to make corrections, enhancements, improvements and other changes to its TI Resources. TI has not conducted any testing other than that specifically described in the published documentation for a particular TI Resource.

Designer is authorized to use, copy and modify any individual TI Resource only in connection with the development of applications that include the TI product(s) identified in such TI Resource. NO OTHER LICENSE, EXPRESS OR IMPLIED, BY ESTOPPEL OR OTHERWISE TO ANY OTHER TI INTELLECTUAL PROPERTY RIGHT, AND NO LICENSE TO ANY TECHNOLOGY OR INTELLECTUAL PROPERTY RIGHT OF TI OR ANY THIRD PARTY IS GRANTED HEREIN, including but not limited to any patent right, copyright, mask work right, or other intellectual property right relating to any combination, machine, or process in which TI products or services are used. Information regarding or referencing third-party products or services does not constitute a license to use such products or services, or a warranty or endorsement thereof. Use of TI Resources may require a license from a third party under the patents or other intellectual property of the third party, or a license from TI under the patents or other intellectual property of TI.

TI RESOURCES ARE PROVIDED "AS IS" AND WITH ALL FAULTS. TI DISCLAIMS ALL OTHER WARRANTIES OR REPRESENTATIONS, EXPRESS OR IMPLIED, REGARDING RESOURCES OR USE THEREOF, INCLUDING BUT NOT LIMITED TO ACCURACY OR COMPLETENESS, TITLE, ANY EPIDEMIC FAILURE WARRANTY AND ANY IMPLIED WARRANTIES OF MERCHANTABILITY, FITNESS FOR A PARTICULAR PURPOSE, AND NON-INFRINGEMENT OF ANY THIRD PARTY INTELLECTUAL PROPERTY RIGHTS. TI SHALL NOT BE LIABLE FOR AND SHALL NOT DEFEND OR INDEMNIFY DESIGNER AGAINST ANY CLAIM, INCLUDING BUT NOT LIMITED TO ANY INFRINGEMENT CLAIM THAT RELATES TO OR IS BASED ON ANY COMBINATION OF PRODUCTS EVEN IF DESCRIBED IN TI RESOURCES OR OTHERWISE. IN NO EVENT SHALL TI BE LIABLE FOR ANY ACTUAL, DIRECT, SPECIAL, COLLATERAL, INDIRECT, PUNITIVE, INCIDENTAL, CONSEQUENTIAL OR EXEMPLARY DAMAGES IN CONNECTION WITH OR ARISING OUT OF TI RESOURCES OR USE THEREOF, AND REGARDLESS OF WHETHER TI HAS BEEN ADVISED OF THE POSSIBILITY OF SUCH DAMAGES.

Unless TI has explicitly designated an individual product as meeting the requirements of a particular industry standard (e.g., ISO/TS 16949 and ISO 26262), TI is not responsible for any failure to meet such industry standard requirements.

Where TI specifically promotes products as facilitating functional safety or as compliant with industry functional safety standards, such products are intended to help enable customers to design and create their own applications that meet applicable functional safety standards and requirements. Using products in an application does not by itself establish any safety features in the application. Designers must ensure compliance with safety-related requirements and standards applicable to their applications. Designer may not use any TI products in life-critical medical equipment unless authorized officers of the parties have executed a special contract specifically governing such use. Life-critical medical equipment is medical equipment where failure of such equipment would cause serious bodily injury or death (e.g., life support, pacemakers, defibrillators, heart pumps, neurostimulators, and implantables). Such equipment includes, without limitation, all medical devices identified by the U.S. Food and Drug Administration as Class III devices and equivalent classifications outside the U.S.

TI may expressly designate certain products as completing a particular qualification (e.g., Q100, Military Grade, or Enhanced Product). Designers agree that it has the necessary expertise to select the product with the appropriate qualification designation for their applications and that proper product selection is at Designers' own risk. Designers are solely responsible for compliance with all legal and regulatory requirements in connection with such selection.

Designer will fully indemnify TI and its representatives against any damages, costs, losses, and/or liabilities arising out of Designer's non-compliance with the terms and provisions of this Notice.