

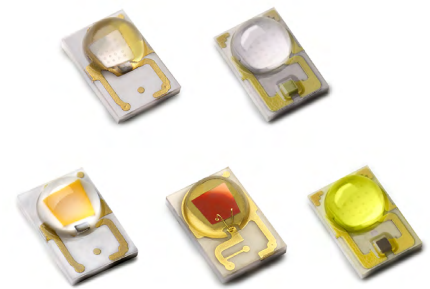

LUXEON Rebel Color Line

High flux and efficacy on industry's most widely used color LED platform

The LUXEON Rebel Color Line has leading light output, color stability, flux density and clear saturated colors. These color LEDs are ideal for a wide variety of lighting, signaling, signage and entertainment applications. Every LUXEON Rebel Color emitter has built-in quality, reliability, lumen maintenance and the ease of manufacturing needed to create a superior, high quality light. LUXEON Rebel Color emitters give designers an endless palette of colors to work with, adding interest, dimension and liveliness to all lighting projects.



FEATURES AND BENEFITS

- Full color palette for a wider spectrum range
- Highest efficacy available for colors, allowing for lower power consumption
- High flux and leading hot and cold performance for saturated colors
- Fully developed ecosystem for LUXEON Rebel platforms
- UL-recognized component [E327436]

PRIMARY APPLICATIONS

- Architectural
- Lamps
- Specialty Lighting
 - Emergency Lighting
 - Entertainment

Table of Contents

General Product Information	2
Product Test Conditions	2
Part Number Nomenclature	2
Lumen Maintenance	2
Environmental Compliance	2
Performance Characteristics	3
Product Selection Guide	3
Electrical and Thermal Characteristics	4
Absolute Maximum Ratings	5
Characteristic Curves	6
Spectral Power Distribution Characteristics	6
Light Output Characteristics	7
Forward Current Characteristics	9
Radiation Pattern Characteristics	13
Product Bin and Labeling Definitions	18
Decoding Product Bin Labeling	18
Luminous Flux Bins	19
Radiometric Power Bins	20
Dominant and Peak Wavelength Bins	21
Color Bin Definitions	22
Forward Voltage Bins	23
Mechanical Dimensions	24
Reflow Soldering Guidelines	26
JEDEC Moisture Sensitivity	26
Solder Pad Design	27
Packaging Information	28
Pocket Tape Dimensions	28
Reel Dimensions	29

General Product Information

Product Test Conditions

LUXEON Rebel Color Line LEDs are tested and binned with a DC drive current and junction temperature specified below:

LUXEON Rebel Lime	– 350mA, $T_j=85^\circ\text{C}$
LUXEON Rebel ES Blue and LUXEON Rebel ES Royal Blue	– 700mA, $T_j=25^\circ\text{C}$
All other colors	– 350mA, $T_j=25^\circ\text{C}$

Part Number Nomenclature

Part numbers for LUXEON Rebel Color Line follow the convention below:

L X M L – P **A 0 B** – **C C C C**
L X M 2 – P **A 0 B** – **C C C C**
L X M 3 – P **A 0 B** – **C C C C**
L X M 5 – P **A 0 B**

Where:

- A** – designates color (X=Lime, M=Green, E=Cyan, B=Blue, R=Royal Blue, F=Far Red, D=Deep Red and Red, H=Red-Orange, L=PC Amber and Amber, B=Blue, R=Royal Blue)
- B** – designates diode size (1=1 mm² and 2=2mm²)
- C C C C** – designates minimum luminous flux (lm) or radiometric power (mW) performance (see Product Selection Guide)

Therefore, the following part number is used for a LUXEON Rebel Red, 1mm² diode size, with a minimum luminous flux of 50:

L X M 2 – P **D 0 1** – **0 0 5 0**

Lumen Maintenance

Please contact your local Sales Representative or Lumileds Technical Solutions Manager for more information about the long-term performance of this product.

Environmental Compliance

Lumileds LLC is committed to providing environmentally friendly products to the solid-state lighting market. LUXEON Rebel Color Line is compliant to the European Union directives on the restriction of hazardous substances in electronic equipment, namely the RoHS Directive 2011/65/EU and REACH Regulation (EC) 1907/2006. Lumileds LLC will not intentionally add the following restricted materials to its products: lead, mercury, cadmium, hexavalent chromium, polybrominated biphenyls (PBB) or polybrominated diphenyl ethers (PBDE).

Performance Characteristics

Product Selection Guide

Table 1. Product performance of LUXEON Rebel Color Line at test conditions.

COLOR	DOMINANT ^[1, 2] or PEAK WAVELENGTH ^[2] (nm)		LUMINOUS FLUX ^[1, 3] (lm) or RADIOMETRIC POWER ^[3] (mW)		TEST CURRENT (mA)	PART NUMBER
	MINIMUM	MAXIMUM	MINIMUM	TYPICAL		
Far Red	720	750	210	260	350	LXML-PF01
Deep Red	650	670	270	360	350	LXM3-PD01
Red	620	645	60	62	350	LXM2-PD01-0060
	620	645	50	53	350	LXM2-PD01-0050
	620	645	40	48	350	LXM2-PD01-0040
	620	645	50	52	350	LXML-PD01-0050
	620	645	40	46	350	LXML-PD01-0040
	620	645	30	38	350	LXML-PD01-0030
	620	645	50	64	350	LXM5-PD01
Red-Orange	610	620	70	72	350	LXM2-PH01-0070
	610	620	60	67	350	LXM2-PH01-0060
	610	620	60	62	350	LXML-PH01-0060
	610	620	50	56	350	LXML-PH01-0050
	610	620	50	90	350	LXM5-PH01
PC Amber	594	604	80	110	350	LXM2-PL01-0000
Amber	585	595	60	61	350	LXML-PL01-0060
	585	595	50	54	350	LXML-PL01-0050
	585	595	40	48	350	LXML-PL01-0040
	585	595	30	38	350	LXML-PL01-0030
	585	595	50	74	350	LXM5-PL01
Lime	566	569	140	184	350	LXML-PX02-0000
Green	520	540	100	102	350	LXML-PM01-0100
	520	540	90	95	350	LXML-PM01-0090
	520	540	80	88	350	LXML-PM01-0080
	520	540	70	79	350	LXML-PM01-0070
Cyan	490	515	80	83	350	LXML-PE01-0080
	490	515	70	76	350	LXML-PE01-0070
	490	515	60	67	350	LXML-PE01-0060
Blue	460	485	40	41	350	LXML-PB01-0040
	460	485	30	35	350	LXML-PB01-0030
	460	485	23	28	350	LXML-PB01-0023
	460	485	18	22	350	LXML-PB01-0018
	460	485	50	74	700	LXML-PB02
Royal Blue	440	460	500	520	350	LXML-PR01-0500
	440	460	1100	1120	700	LXML-PR02-1100
	440	460	1050	1070	700	LXML-PR02-1050
	440	460	1000	1030	700	LXML-PR02-1000
	440	460	950	970	700	LXML-PR02-0950
	440	460	900	940	700	LXML-PR02-0900
	440	460	800	890	700	LXML-PR02-0800
	440	460	900	1030	700	LXML-PR02-A900 ^[4]

Notes for Table 1:

- Lumileds maintains a tolerance of $\pm 0.5\text{nm}$ for dominant wavelength and $\pm 6.5\%$ on luminous flux measurements.
- Far Red, Deep Red and Royal Blue are binned by peak wavelength and all other colors by dominant wavelength.
- Far Red, Deep Red and Royal Blue are binned by radiometric power and all other colors by luminous flux.
- LXML-PR02-A900 is a selection of color bins 4 and 5 only.

Table 2. Optical characteristics for LUXEON Rebel Color Line at test conditions.

COLOR	PART NUMBER	TYPICAL SPECTRAL HALF-WIDTH ^[1] (nm)	TYPICAL TEMPERATURE COEFFICIENT OF DOMINANT or PEAK WAVELENGTH (nm/°C)	TYPICAL TOTAL INCLUDED ANGLE ^[2]	TYPICAL VIEWING ANGLE ^[3]
Far Red	LXML-PF01 ^[4]	30	0.17	145°	125°
Deep Red	LXM3-PD01 ^[4]	20	0.05	145°	125°
Red	LXM2-PD01 ^[4, 6]	20	0.05	145°	125°
	LXML-PD01 ^[4, 6]	20	0.05	145°	125°
	LXM5-PD01 ^[4, 6]	20	0.05	145°	125°
Red-Orange	LXM2-PH01 ^[4, 6]	20	0.08	145°	125°
	LXML-PH01 ^[4, 6]	20	0.08	145°	125°
	LXM5-PH01 ^[4, 6]	20	0.08	145°	125°
PC Amber	LXM2-PL01 ^[5]	80	-0.01	140°	120°
Amber	LXML-PL01 ^[4, 6]	20	0.10	145°	125°
	LXM5-PL01 ^[4, 6]	20	0.10	145°	125°
Lime	LXML-PX02 ^[5]	100	0.01	145°	125°
Green	LXML-PM01 ^[5]	30	0.05	145°	125°
Cyan	LXML-PE01 ^[5]	30	0.04	145°	125°
Blue	LXML-PB01 ^[5]	20	0.05	145°	125°
	LXML-PB02 ^[5]	20	0.05	145°	125°
Royal Blue	LXML-PR01 ^[5]	20	0.04	145°	125°
	LXML-PR02 ^[5]	20	0.04	145°	125°

Notes for Table 2:

- Spectral width at ½ of the peak intensity.
- Total angle at which 90% of total luminous flux is captured.
- Viewing angle is the off axis angle from the LED centerline where the luminous intensity is ½ of the peak value.
- Far Red, Deep Red, Red, Red-Orange and Amber products are built with aluminum indium gallium phosphide (AlInGaP).
- PC Amber, Lime, Green, Cyan, Blue and Royal Blue products are built with Indium Gallium Nitride (InGaN).
- Wavelength ranges for hot tested Red, Red-Orange and Amber have been defined to align with typical changes in spectral output at increased temperature.

Electrical and Thermal Characteristics

Table 3. Electrical and thermal characteristics for LUXEON Rebel Color Line at test conditions.

COLOR	PART NUMBER	FORWARD VOLTAGE ^[1] (V _f)			TYPICAL TEMPERATURE COEFFICIENT OF FORWARD VOLTAGE ^[2] (mV/°C)	TYPICAL THERMAL RESISTANCE—JUNCTION TO SOLDER PAD (°C/W)
		MINIMUM	TYPICAL	MAXIMUM		
Far Red	LXML-PF01	1.60	1.80	2.40	-2.0 to -4.0	5.50
Deep Red	LXM3-PD01	1.80	2.10	2.80	-2.0 to -4.0	8.00
Red	LXM2-PD01	1.80	2.10	2.80	-2.0 to -4.0	8.00
	LXML-PD01	2.31	2.90	3.51	-2.0 to -4.0	12.00
	LXM5-PD01	1.80	2.10	2.60	-2.0 to -4.0	7.00
Red-Orange	LXM2-PH01	1.80	2.10	2.80	-2.0 to -4.0	8.00
	LXML-PH01	2.31	2.90	3.51	-2.0 to -4.0	12.00
	LXM5-PH01	1.80	2.10	2.60	-2.0 to -4.0	7.00
PC Amber	LXM2-PL01	2.55	3.05	3.51	-2.0 to -4.0	10.00
Amber	LXML-PL01	2.31	2.90	3.51	-2.0 to -4.0	12.00
	LXM5-PL01	1.80	2.10	2.60	-2.0 to -4.0	7.00
Lime	LXML-PX02	2.60	2.75	3.00	-2.0 to -4.0	6.00
Green	LXML-PM01	2.55	3.21	3.51	-2.0 to -4.0	10.00
Cyan	LXML-PE01	2.55	3.17	3.51	-2.0 to -4.0	10.00
Blue	LXML-PB01	2.55	2.95	3.51	-2.0 to -4.0	10.00
	LXML-PB02	2.50	2.95	3.50	-2.0 to -4.0	6.00
Royal Blue	LXML-PR01	2.55	2.95	3.51	-2.0 to -4.0	10.00
	LXML-PR02	2.50	2.90	3.50	-2.0 to -4.0	6.00

Notes for Table 3:

- Lumileds maintains a tolerance of ±0.06V on forward voltage measurements.
- Measured between 25°C and 110°C.

Absolute Maximum Ratings

Table 4a. Absolute maximum ratings for LUXEON Rebel Color Line at $T_j=25^\circ\text{C}$.

PARAMETER	GREEN/CYAN/ BLUE/ROYAL BLUE	ES BLUE/ ES ROYAL BLUE	FAR RED/ DEEP RED/RED/ RED-ORANGE/AMBER	PC AMBER
DC Forward Current ^[1,2]	1000mA	1000	700mA	700mA
Peak Pulsed Forward Current ^[1,3]	1200mA	1200	875mA	875mA
LED Junction Temperature ^[1] (DC & Pulse)	150°C	150°C	135°C	130°C
ESD Sensitivity (ANSI/ESDA/JEDEC JS-001-2012)	Class 3A	Class 3A	Class 3A	Class 3A
Operating Case Temperature ^[1]	-40°C to 135°C	-40°C to 135°C	-40°C to 120°C	-40°C to 110°C
LED Storage Temperature	-40°C to 135°C	-40°C to 135°C	-40°C to 135°C	-40°C to 135°C
Soldering Temperature	JEDEC 020c 260°C	JEDEC 020c 260°C	JEDEC 020c 260°C	JEDEC 020c 260°C
Allowable Reflow Cycles	3	3	3	3
Autoclave Conditions	-121°C at 2 ATM 100% Relative Humidity for 96 Hours Maximum			
Reverse Voltage (V_{reverse})	LUXEON LEDs are not designed to be driven in reverse bias			

Notes for Table 4a:

1. Proper current derating must be observed to maintain the junction temperature below the maximum.
2. Residual periodic variations due to power conversion from alternating current (AC) to direct current (DC), also called "ripple," with frequencies $\geq 100\text{Hz}$ and amplitude $\leq 15\%$ of the maximum allowable DC forward current are acceptable, assuming the average current throughout each cycle does not exceed the maximum allowable DC forward current at the corresponding maximum junction temperature.
3. Pulsed operation with a peak drive current equal to the stated peak pulsed forward current is acceptable if the pulse on-time is $\leq 5\text{ms}$ per cycle and the duty cycle is $\leq 50\%$.

Table 4b. Absolute maximum ratings for LUXEON Rebel Color Line at $T_j=85^\circ\text{C}$.

PARAMETER	LIME
DC Forward Current ^[1,2]	1000
Peak Pulsed Forward Current ^[1,3]	1200
LED Junction Temperature ^[1] (DC & Pulse)	150°C
ESD Sensitivity (ANSI/ESDA/JEDEC JS-001-2012)	Class 3A
Operating Case Temperature ^[1]	-40°C to 135°C
LED Storage Temperature	-40°C to 135°C
Soldering Temperature	JEDEC 020c 260°C
Allowable Reflow Cycles	3
Autoclave Conditions	100% Relative Humidity for 96 Hours Maximum
Reverse Voltage (V_{reverse})	LUXEON LEDs are not designed to be driven in reverse bias

Notes for Table 4b:

1. Proper current derating must be observed to maintain the junction temperature below the maximum.
2. Residual periodic variations due to power conversion from alternating current (AC) to direct current (DC), also called "ripple," with frequencies $\geq 100\text{Hz}$ and amplitude $\leq 15\%$ of the maximum allowable DC forward current are acceptable, assuming the average current throughout each cycle does not exceed the maximum allowable DC forward current at the corresponding maximum junction temperature.
3. Pulsed operation with a peak drive current equal to the stated peak pulsed forward current is acceptable if the pulse on-time is $\leq 5\text{ms}$ per cycle and the duty cycle is $\leq 50\%$.

Characteristic Curves

Spectral Power Distribution Characteristics

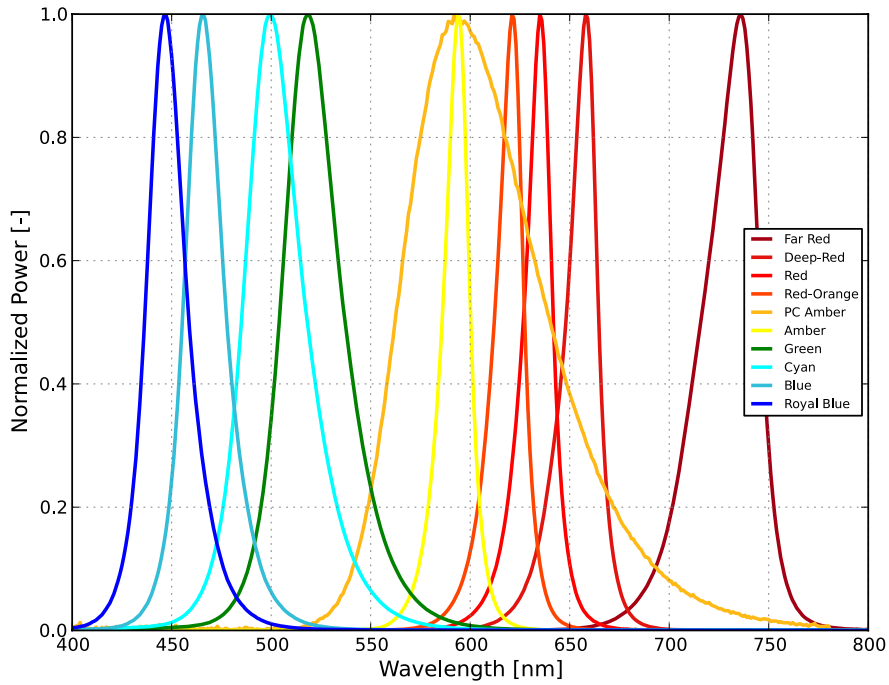

Figure 1a. Typical normalized power vs. wavelength for LUXEON Rebel Far Red, Deep Red, Red, Red-Orange, PC Amber, Amber, Green, Cyan, Blue and Royal Blue at test current, $T_j=25^{\circ}\text{C}$.

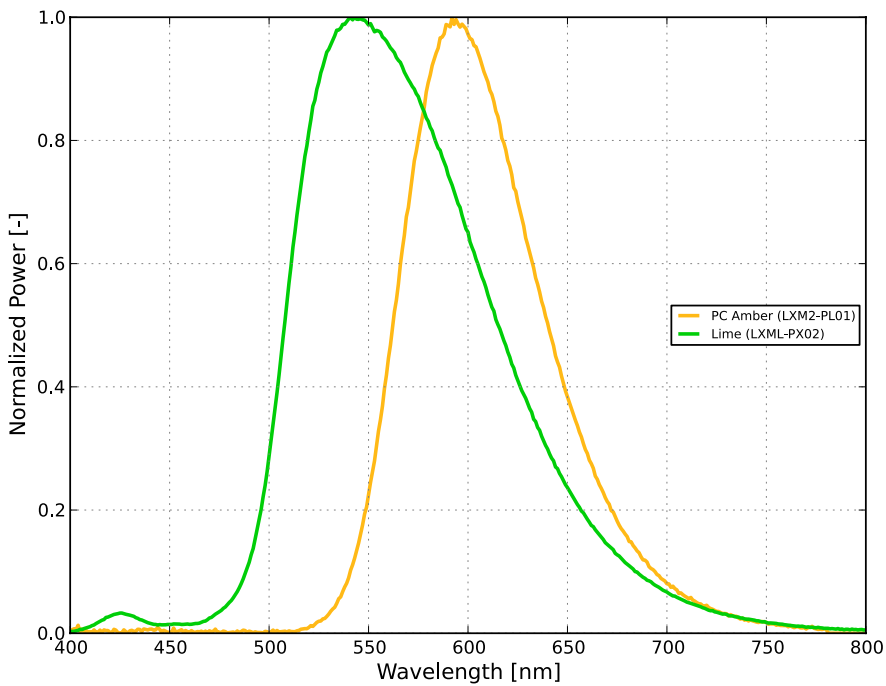

Figure 1b. Typical normalized power vs. wavelength for LUXEON Rebel PC Amber and Lime at 350mA, test temperature.

Light Output Characteristics

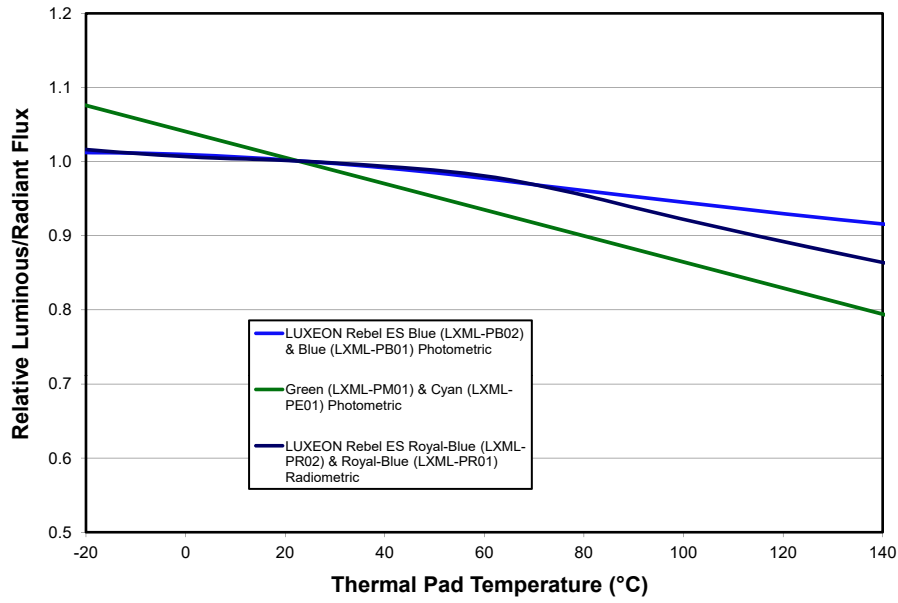

Figure 2a. Typical normalized light output vs. junction temperature for LXML-PM01, LXML-PE01, LXML-PB01, LXML-PB02, LXML-PR01 and LXML-PR02 at test current.

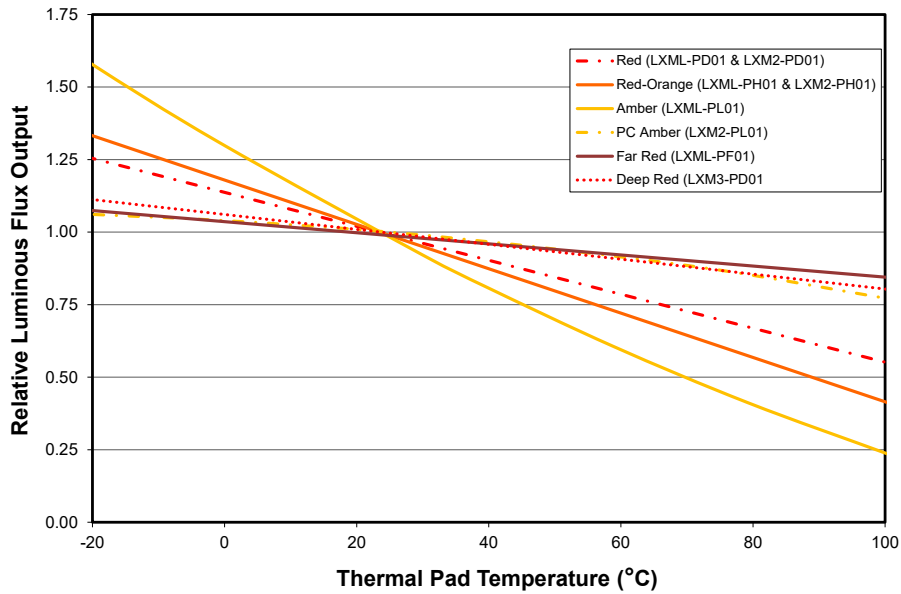

Figure 2b. Typical normalized light output vs. junction temperature for LXML-PF01, LXM3-PD01, LXM2-PD01, LXML-PD01, LXM2-PH01, LXML-PH01, LXM2-PL01, LXML-PL01 at test current.

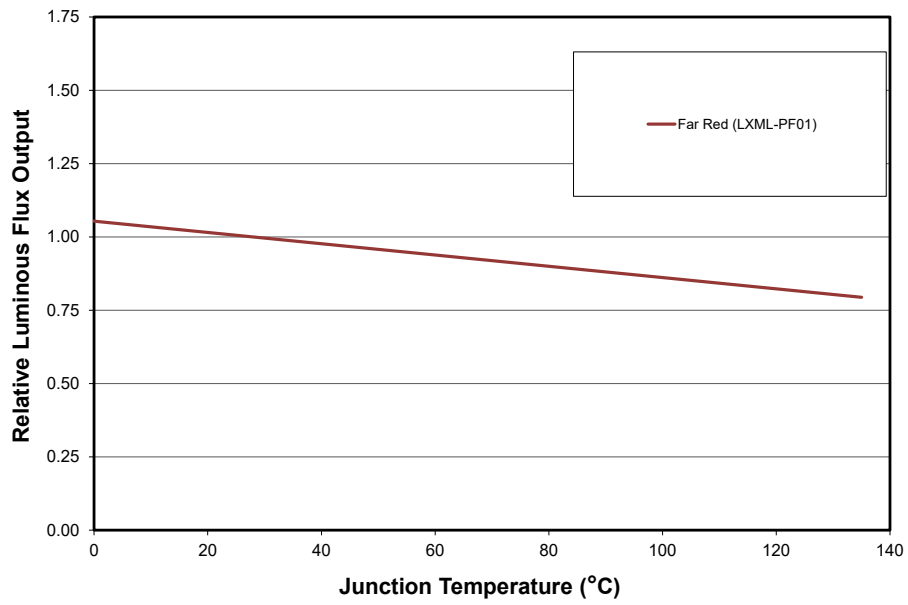

Figure 2c. Typical normalized light output vs. junction temperature for LXML-PF01 at test current.

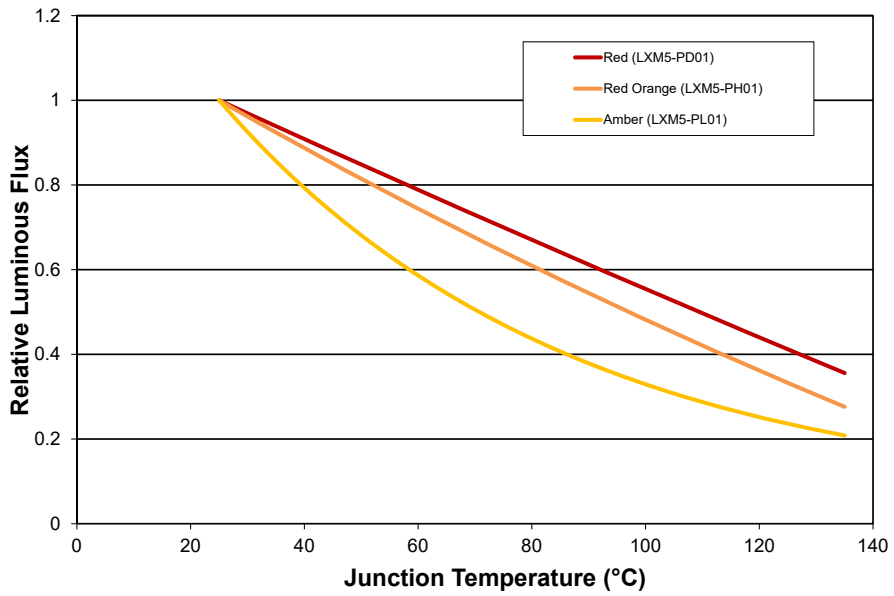

Figure 2d. Typical normalized light output vs. junction temperature for LXM5-PD01, LXM5-PH01 and LXM5-PL01 at test current.

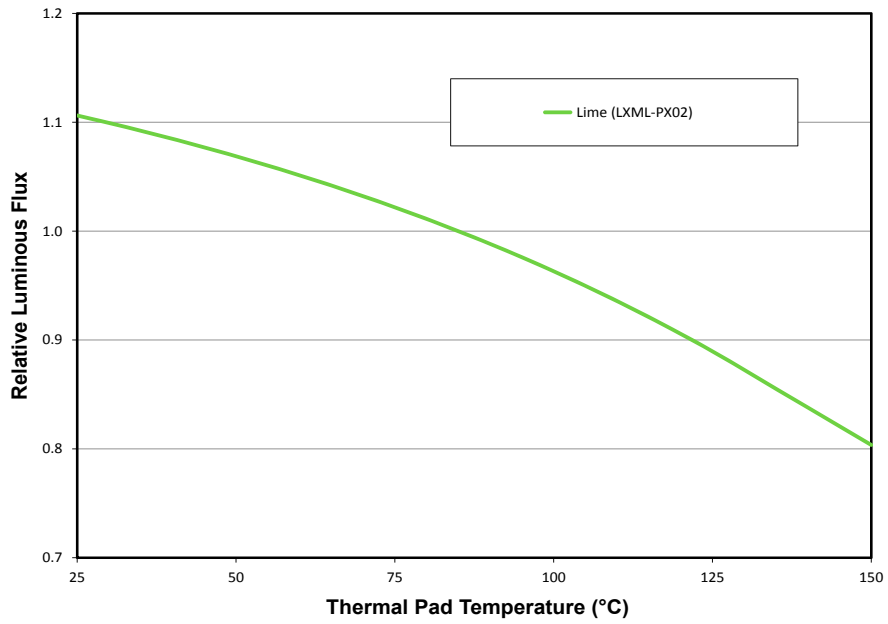

Figure 2e. Typical normalized light output vs. junction temperature for LXML-PX02 at test current.

Forward Current Characteristics

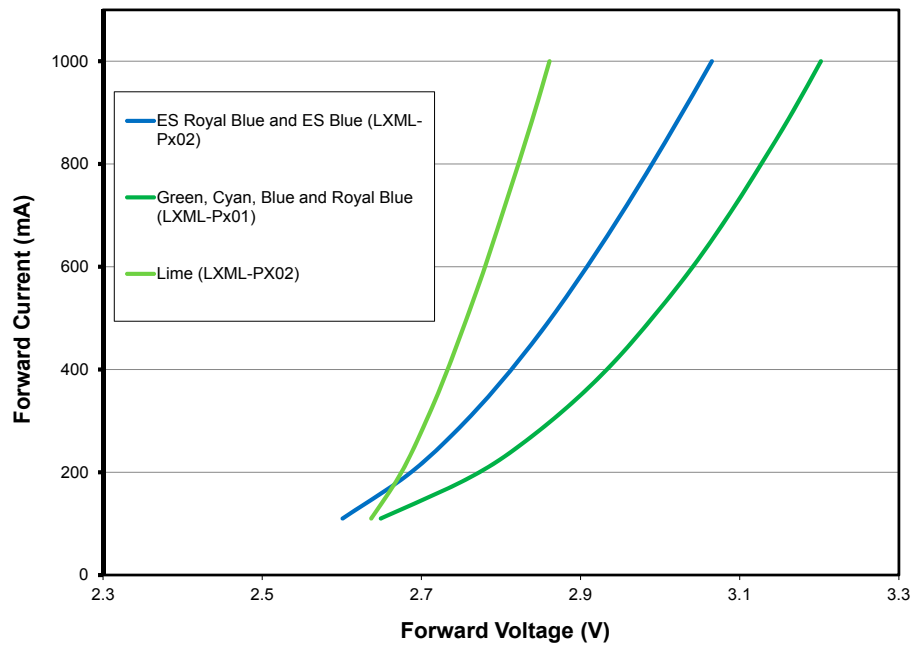

Figure 3a. Typical forward current vs. forward voltage for LXML-PX02, LXML-Px01 and LXML-Px02 at test temperature.

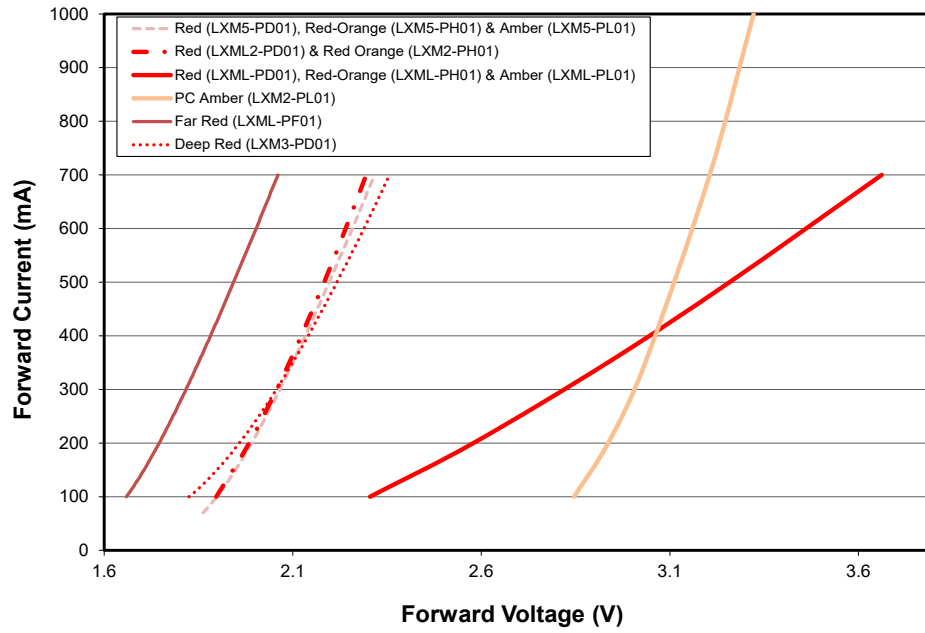

Figure 3b. Typical forward current vs. forward voltage for LXML-PF01, LXM3-PD01, LXM2-PD01, LXM5-PD01, LXML-PD01, LXM2-PH01, LXM5-PH01, LXML-PH01, LXM2-PL01, LXM5-PL01 and LXML-PL01 at test temperature.

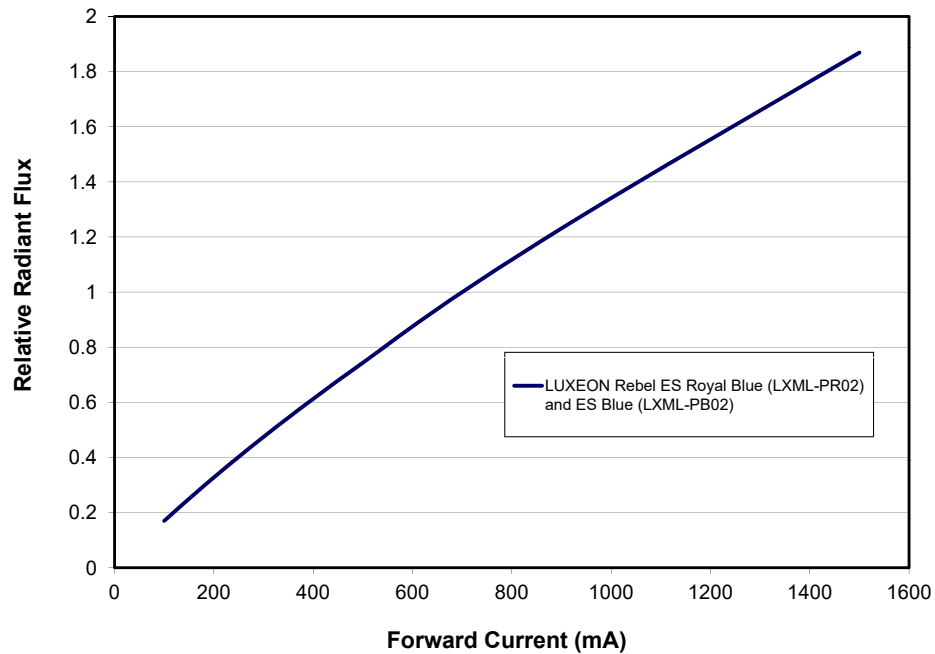

Figure 3c. Relative luminous flux or radiometric power vs. forward current for LXML-PB02 and LXML-PR02 at test temperature.

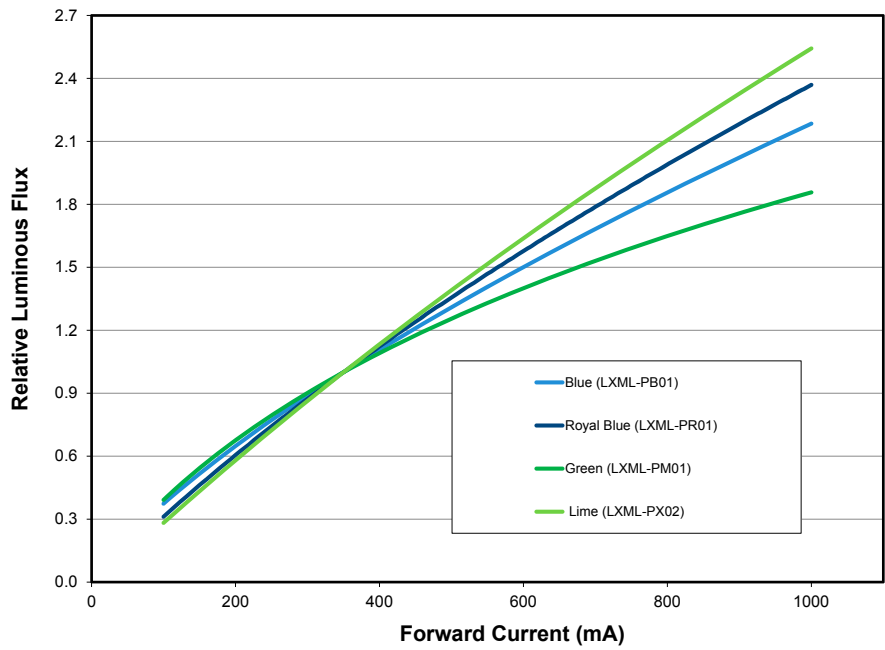

Figure 3d. Relative luminous flux vs. forward current for LXML-PX02, LXML-PM01, LXML-PB01 and LXML-PR01 at test temperature.

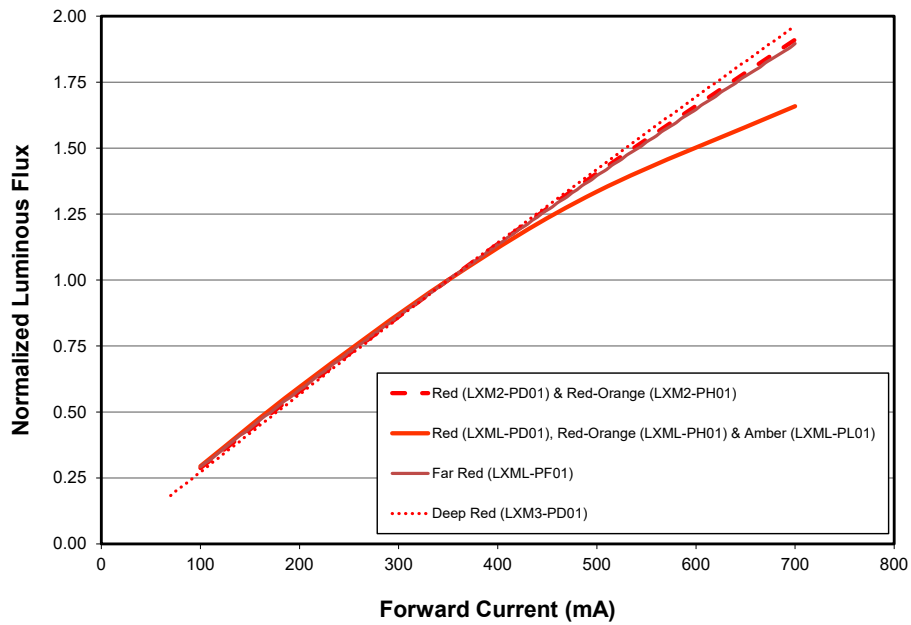

Figure 3e. Normalized luminous flux or radiometric power vs. forward current for LXML-PF01, LXM3-PD01, LXM2-PD01, LXM5-PD01, LXML-PD01, LXM2-PH01, LXM5-PH01, LXML-PH01, LXM5-PL01 and LXML-PL01 at test temperature.

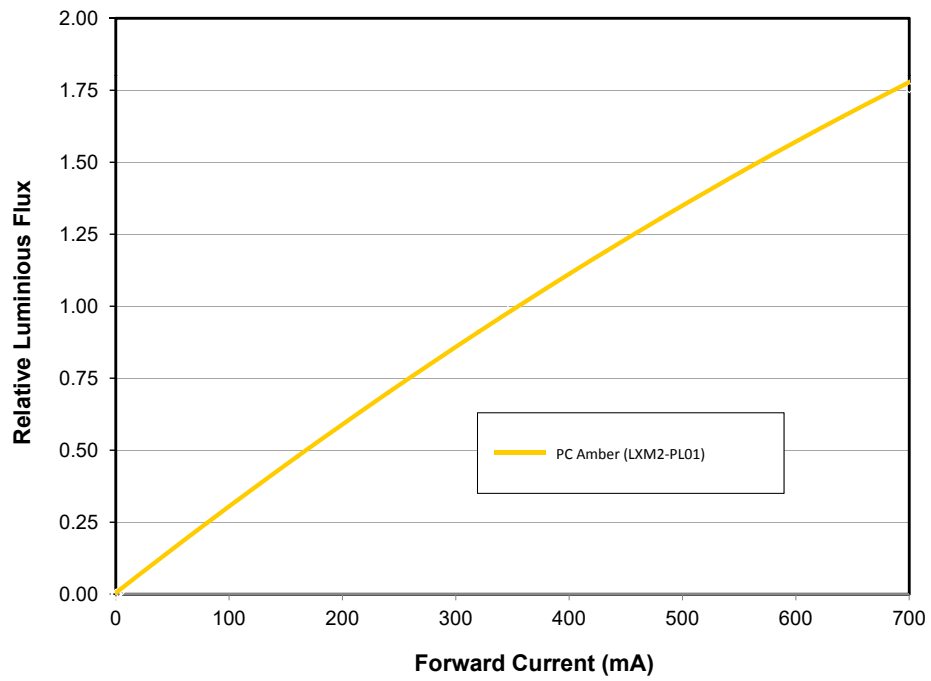

Figure 3f. Relative luminous flux vs. forward current for LXM2-PL01 at test temperature.

Radiation Pattern Characteristics

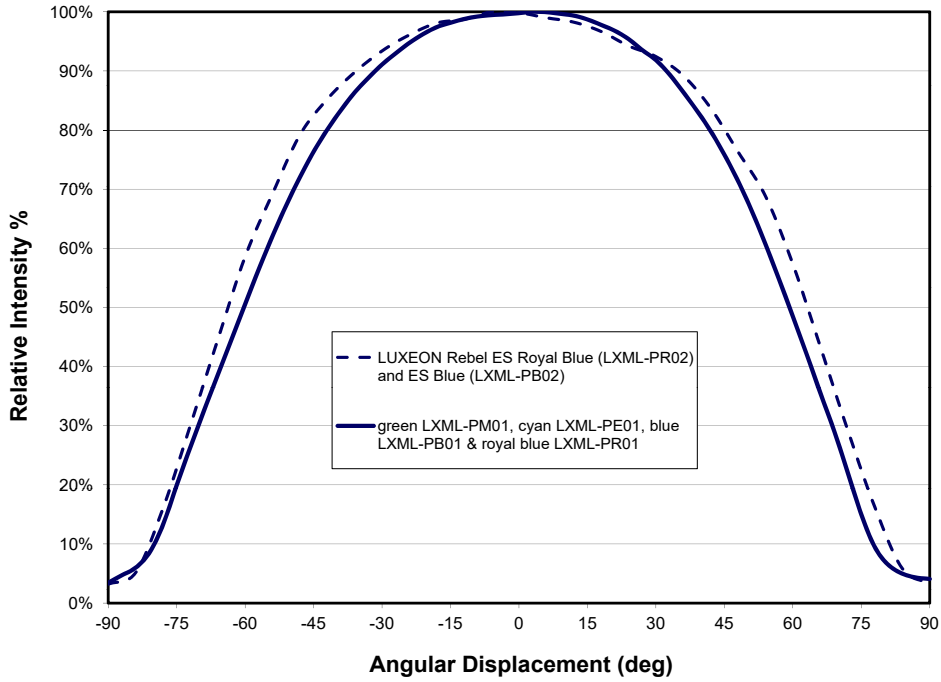

Figure 4a. Typical radiation pattern for LXML-PM01, LXML-PE01, LXML-PB01, LXML-PB02, LXML-PR01 and LXML-PR02 at test conditions.

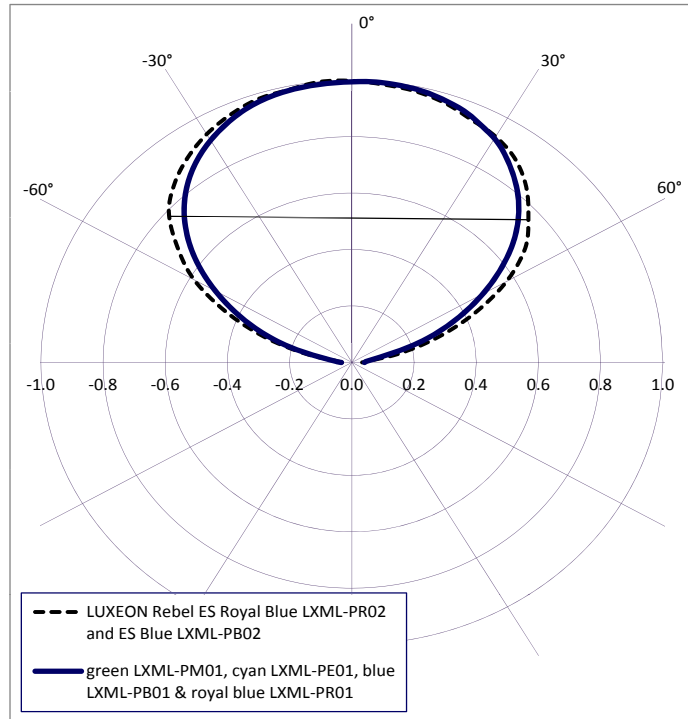

Figure 5a. Typical polar radiation pattern for LXML-PM01, LXML-PE01, LXML-PB01, LXML-PB02, LXML-PR01 and LXML-PR02 at test conditions.

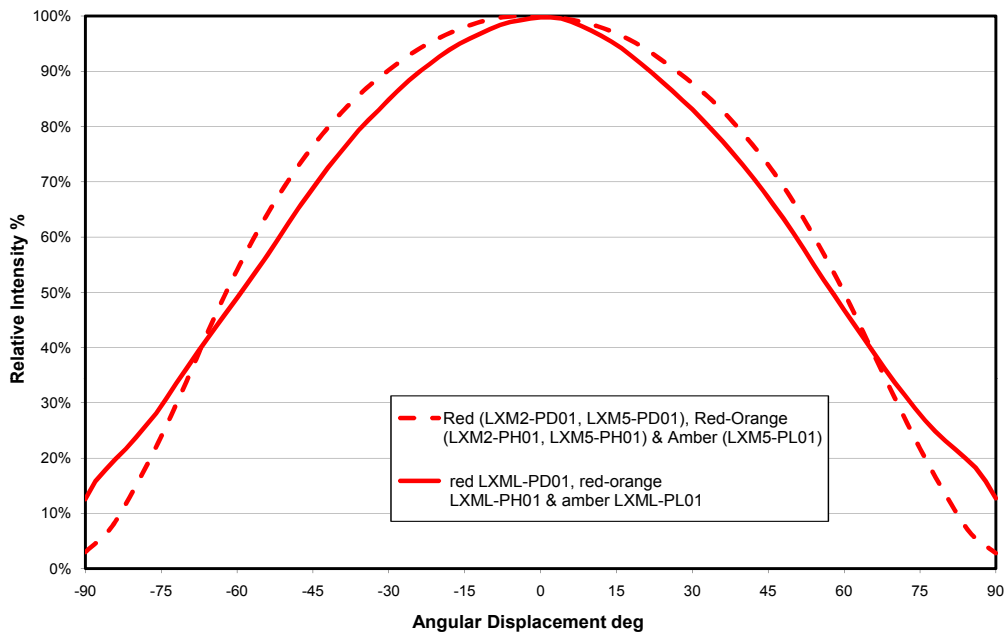

Figure 4b. Typical radiation pattern for LXM2-PD01, LXM5-PD01, LXML-PD01, LXM2-PH01, LXM5-PH01, LXML-PH01, LXM5-PL01 and LXML-PL01 at test conditions.

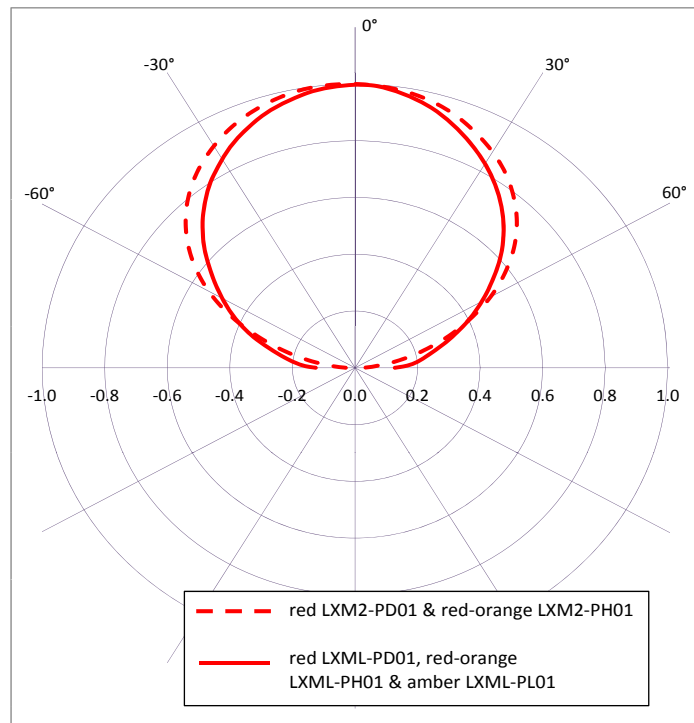

Figure 5b. Typical polar radiation pattern for LXM2-PD01, LXML-PD01, LXM2-PH01, LXML-PH01 and LXML-PL01 at test conditions.

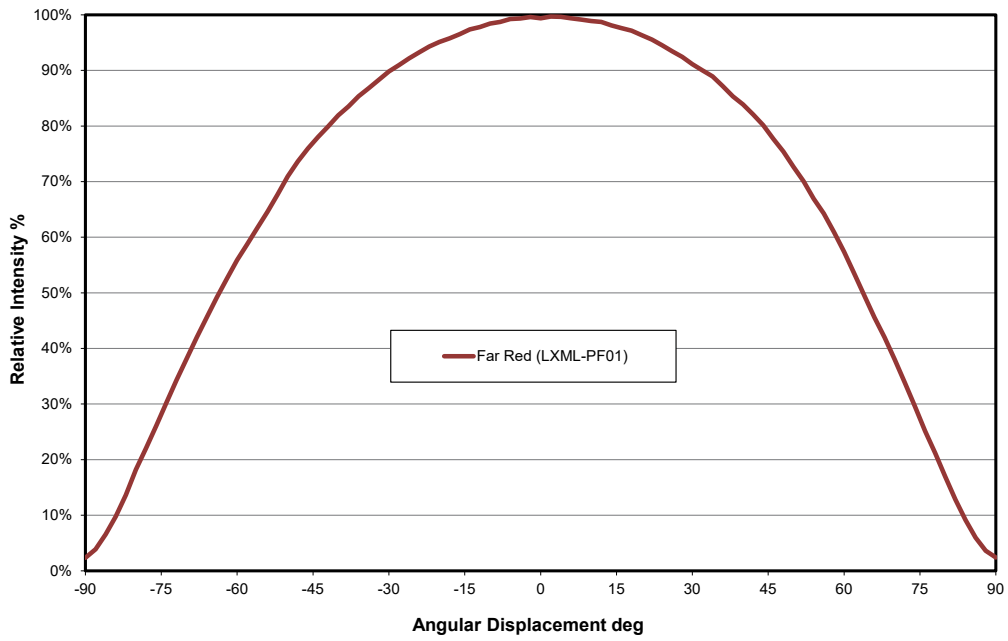

Figure 4c. Typical radiation pattern for LXML-PF01 at test conditions.

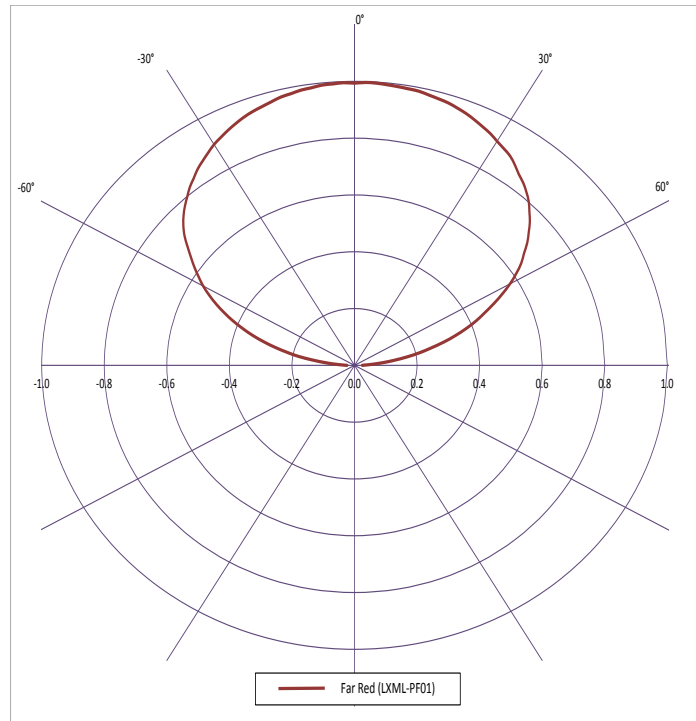

Figure 5c. Typical polar radiation pattern for LXML-PF01 at test conditions.

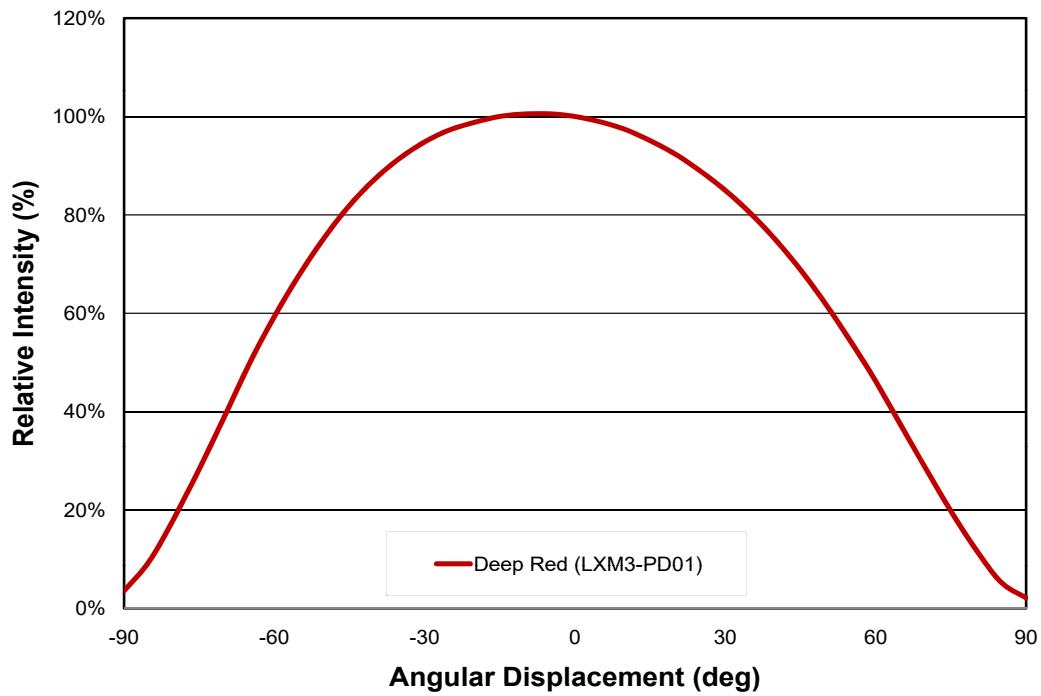

Figure 4d. Typical radiation pattern for LXM3-PD01 at test conditions.

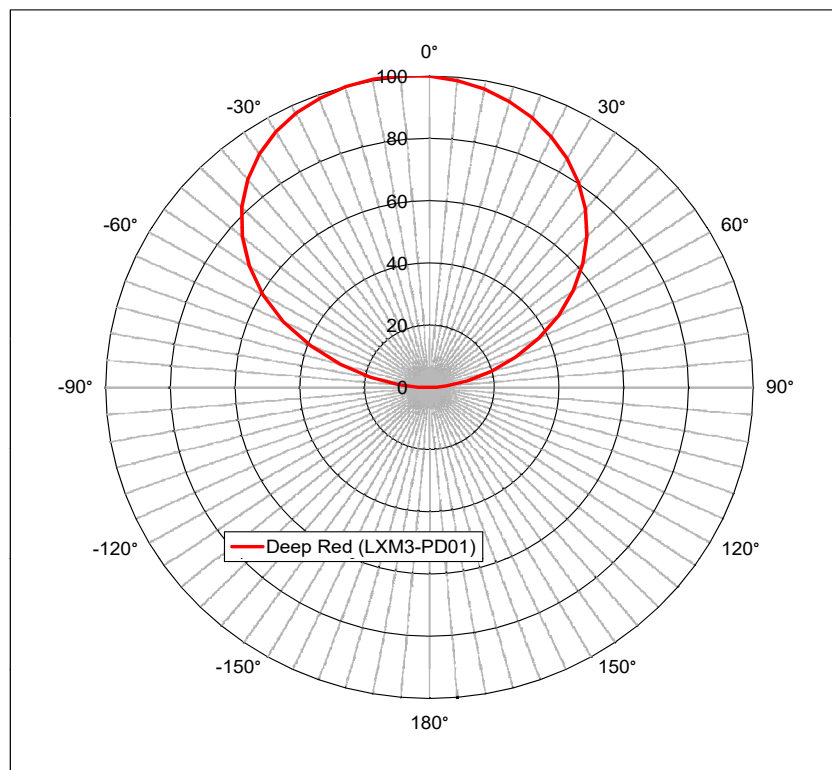

Figure 5d. Typical polar radiation pattern for LXM3-PD01 at test conditions.

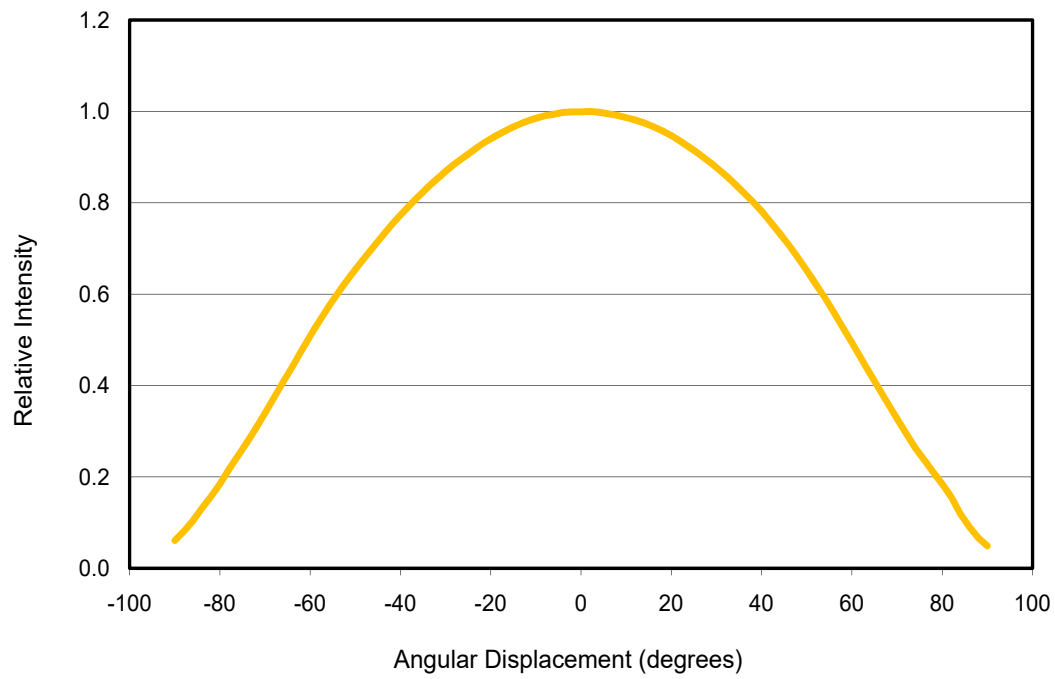

Figure 4e. Typical radiation pattern for LXM2-PL01 at test conditions.

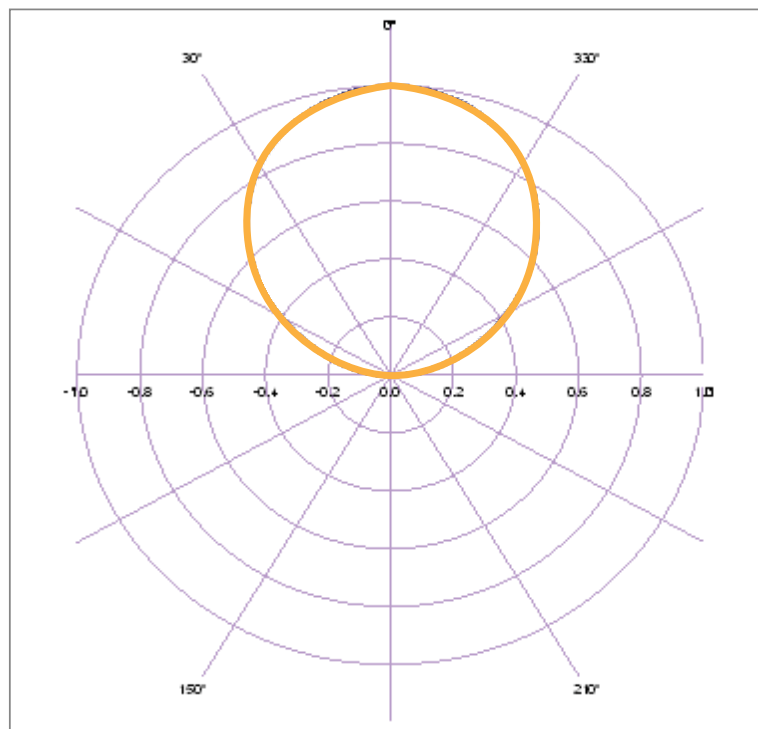

Figure 5e. Typical polar radiation pattern for LXM2-PL01 at test conditions.

Product Bin and Labeling Definitions

Decoding Product Bin Labeling

In the manufacturing of semiconductor products, there are variations in performance around the average values given in the technical datasheet. For this reason, Lumileds bins LED components for luminous flux or radiometric power, color point, peak or dominant wavelength and forward voltage.

Reels of LUXEON Rebel Far Red, Deep Red, Red, Red-Orange, PC Amber, Amber, Green, Cyan, Blue and Royal Blue are labeled using a 3-digit alphanumeric CAT code following the format below:

A B C

Where:

- A** – designates luminous flux or radiometric power bin (example: Deep Red D=300 to 350 lumens, Green K=70 to 80 lumens)
- B** – designates peak or dominant wavelength bin (example: Green 2=525 to 530nm, Cyan 2=495 to 500nm)
- C** – designates forward voltage bin (example: Far Red U=1.60 to 1.80V, Green B=2.55 to 2.79V)

Therefore, LUXEON Rebel Green with a lumen range of 70 to 80, a dominant wavelength of 525 to 530nm and a forward voltage range of 2.55 to 2.79V has the following CAT code:

K 2 B

Reels of LUXEON Rebel Lime are labeled using a 4-digit alphanumeric CAT code following the format below:

A B C D

Where:

- A** – designates luminous flux bin (example: F=150 to 160 lumens, J=180 to 190 lumens, M=210 to 220 lumens)
- B C** – designates color bin (example: A0)
- D** – designates forward voltage bin (example: P=2.60 to 2.75V, R=2.75 to 3.00V)

Therefore, LUXEON Rebel Lime with a lumen range of 180 to 190, color bin A0 and a forward voltage range of 2.75 to 3.00V has the following CAT code:

J A 0 R

Luminous Flux Bins

Tables 5a and 5b list the standard luminous flux bins for LUXEON Rebel Color Line emitters. Although several bins are outlined, product availability in a particular bin varies by production run and by product performance. Not all bins are available in all CCTs.

Table 5a. Luminous flux bin definitions for LUXEON Rebel Red, Red-Orange, PC Amber, Amber, Green, Cyan and Blue.

BIN	LUMINOUS FLUX ^[1] (lm)	
	MINIMUM	MAXIMUM
D	18	24
E	24	30
F	30	40
G	40	50
H	50	60
J	60	70
K	70	80
L	80	90
M	90	100
N	100	110
X	110	120
P	120	130
Y	130	140
Q	140	160
R	160	180
S	180	200

Notes for Table 5a:

1. Lumileds maintains a tolerance of $\pm 6.5\%$ on luminous flux measurements.
2. Tested and binned at test conditions.

Table 5b. Luminous flux bin definitions for LUXEON Rebel Lime.

BIN	LUMINOUS FLUX ^[1] (lm)	
	MINIMUM	MAXIMUM
E	140	150
F	150	160
G	160	170
H	170	180
J	180	190
K	190	200
L	200	210
M	210	220

Notes for Table 5b:

1. Lumileds maintains a tolerance of $\pm 6.5\%$ on luminous flux measurements.
2. Tested and binned at test conditions.

Radiometric Power Bins

Table 6a. Radiometric power bin definitions for LUXEON Rebel Royal Blue.

BIN	RADIOMETRIC POWER ^[1] (mW)	
	MINIMUM	MAXIMUM
D	350	425
E	425	500
F	500	600
G	600	700
H	700	800
J	800	900
K	900	950
Y	950	1000
A	1000	1050
B	1050	1100
M	1100	1200
N	1200	1300
P	1300	1400

Notes for Table 6a:

1. Lumileds maintains a tolerance of $\pm 6.5\%$ for radiometric power measurements.
2. Tested and binned at test conditions.

Table 6b. Radiometric power bin definitions for LUXEON Rebel Far Red and Deep Red.

BIN	RADIOMETRIC POWER ^[1] (mW)	
	MINIMUM	MAXIMUM
B	210	260
C	260	300
D	300	350
E	350	400

Notes for Table 6b:

1. Lumileds maintains a tolerance of $\pm 6.5\%$ for radiometric power measurements.
2. Tested and binned at test conditions.

Dominant and Peak Wavelength Bins

Table 7a. Dominant wavelength bin definitions for LUXEON Rebel Red, Red-Orange, Amber, Green, Cyan and Blue.

COLOR	PART NUMBER	BIN	DOMINANT WAVELENGTH ⁽¹⁾ (nm)	
			MINIMUM	MAXIMUM
Red	LXM2-PD01, LXM5-PD01 and LXML-PD01	4	620	630
		5	630	645
Red-Orange	LXM2-PH01, LXM5-PH01 and LXML-PH01	2	610	620
Amber	LXM5-PL01 and LXML-PL01	1	585	587
		2	587	590
		4	590	592
		6	592	595
Green	LXML-PM01	1	520	525
		2	525	530
		3	530	535
		4	535	540
Cyan	LXML-PE01	1	490	495
		2	495	500
		3	500	505
		4	505	510
		5	510	515
Blue	LXML-PB01 and LXML-PB02	1	460	465
		2	465	470
		3	470	475
		4	475	480
		5	480	485

Notes for Table 7a:

1. Lumileds maintains a tolerance of ±0.5nm for dominant wavelength measurements.

Table 7b. Peak wavelength bin definitions for LUXEON Rebel Far Red, Deep Red and Royal Blue.

COLOR	PART NUMBER	BIN	PEAK WAVELENGTH ⁽¹⁾ (nm)	
			MINIMUM	MAXIMUM
Far Red	LXML-PF01	1	720	730
		2	730	740
		3	740	750
Deep Red	LXM3-PD01	6	650	660
		7	660	670
Royal Blue	LXML-PR01 and LXML-PR02	3	440	445
		4	445	450
		5	450	455
		6	455	460

Notes for Table 7b:

1. Lumileds maintains a tolerance of ±2nm for peak wavelength measurements.

Color Bin Definitions

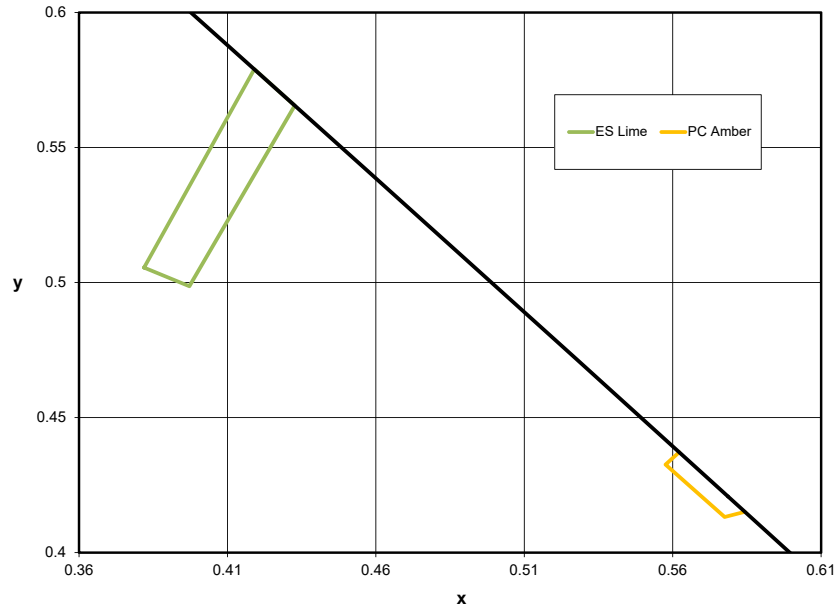

Figure 6. Color bin structure for LUXEON Rebel PC Amber and Lime for Table 8.

Table 8. Peak wavelength bin definitions for LUXEON Rebel PC Amber and Lime.

COLOR	PART NUMBER	BIN	x	y
PC Amber	LXM2-PL01	2	0.5622	0.4372
			0.5576	0.4326
			0.5775	0.4132
			0.5843	0.4151
Lime	LXML-PX02	A0	0.3819	0.5055
			0.4191	0.5790
			0.4327	0.5655
			0.3972	0.4986

Notes for Table 8:

- Lumileds maintains a tolerance of ± 0.005 on x and y coordinates in the CIE 1931 color space.

Forward Voltage Bins

Table 9. Forward voltage bin definitions for LUXEON Rebel Color Line at test conditions.

PART NUMBER	BIN	FORWARD VOLTAGE ^[1] (V _f)	
		MINIMUM	MAXIMUM
	U	1.60	1.80
Far Red - LXML-PF01	V	1.80	2.00
Deep Red - LXM3-PD01	W	2.00	2.20
Red - LXM2-PD01	X	2.20	2.40
Red - LXM5-PD01	Y	2.40	2.60
Red-Orange - LXM2-PH01	Z	2.60	2.80
Red-Orange - LXM5-PH01	P	2.60	2.75
Amber - LXM5-PL01	R	2.75	3.00
Lime - LXML-PX02	A	2.31	2.55
Red - LXML-PD01	B	2.55	2.79
Red-Orange - LXML-PH01	C	2.79	3.03
PC Amber - LXM2-PL01	D	3.03	3.27
Amber - LXML-PL01	E	3.27	3.51
Green - LXML-PM01	P	2.50	2.75
Cyan - LXML-PE01	R	2.75	3.00
Blue - LXML-PB01	S	3.00	3.25
Royal Blue - LXML-PR01	T	3.25	3.50
ES Blue - LXML-PB02			
ES Royal Blue - LXML-PR02			

Notes for Table 9:

1. Lumileds maintains a tolerance of $\pm 0.06V$ on forward voltage measurements.

Mechanical Dimensions

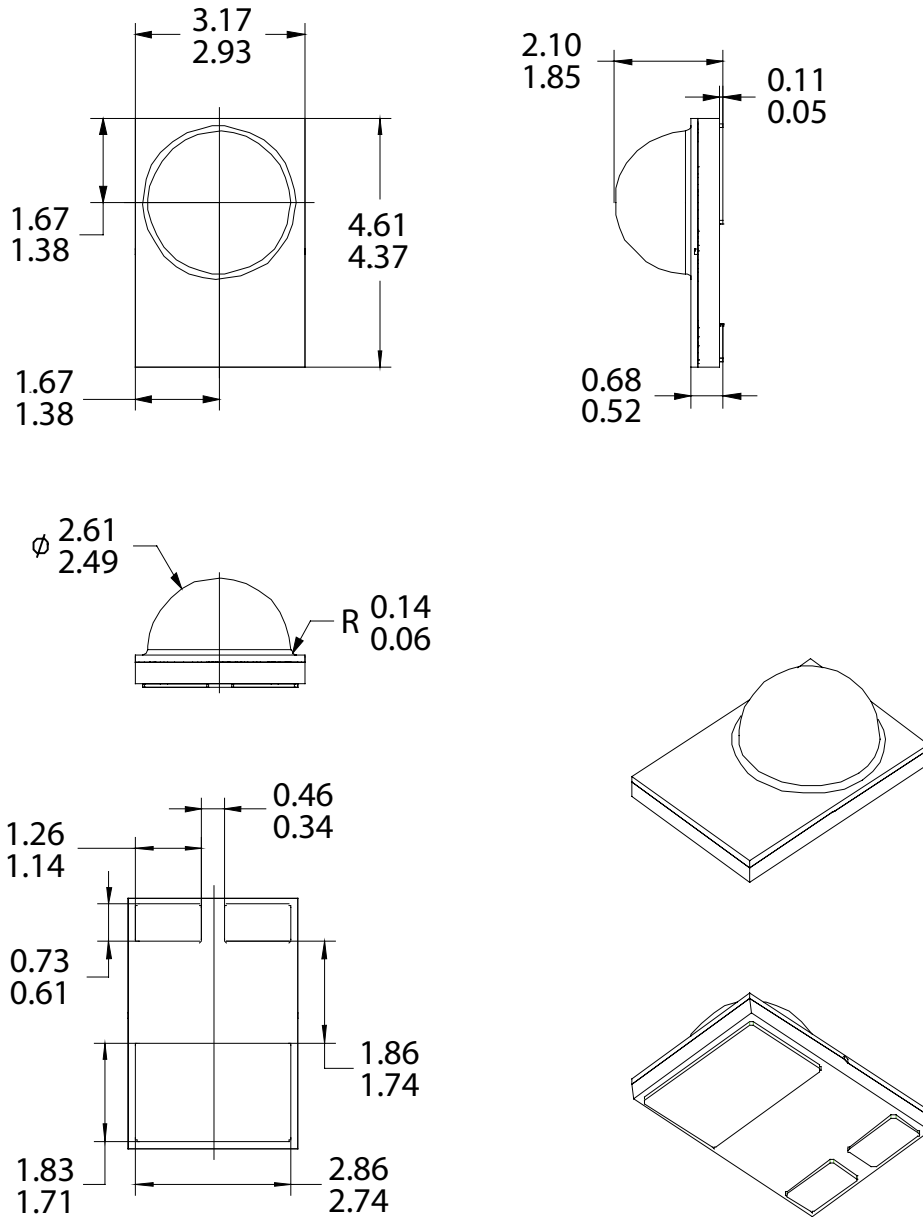

Figure 7a. Mechanical dimensions for LUXEON Rebel Color Line.

Notes for Figure 7a:

1. Drawings are not to scale.
2. All dimensions are in millimeters.

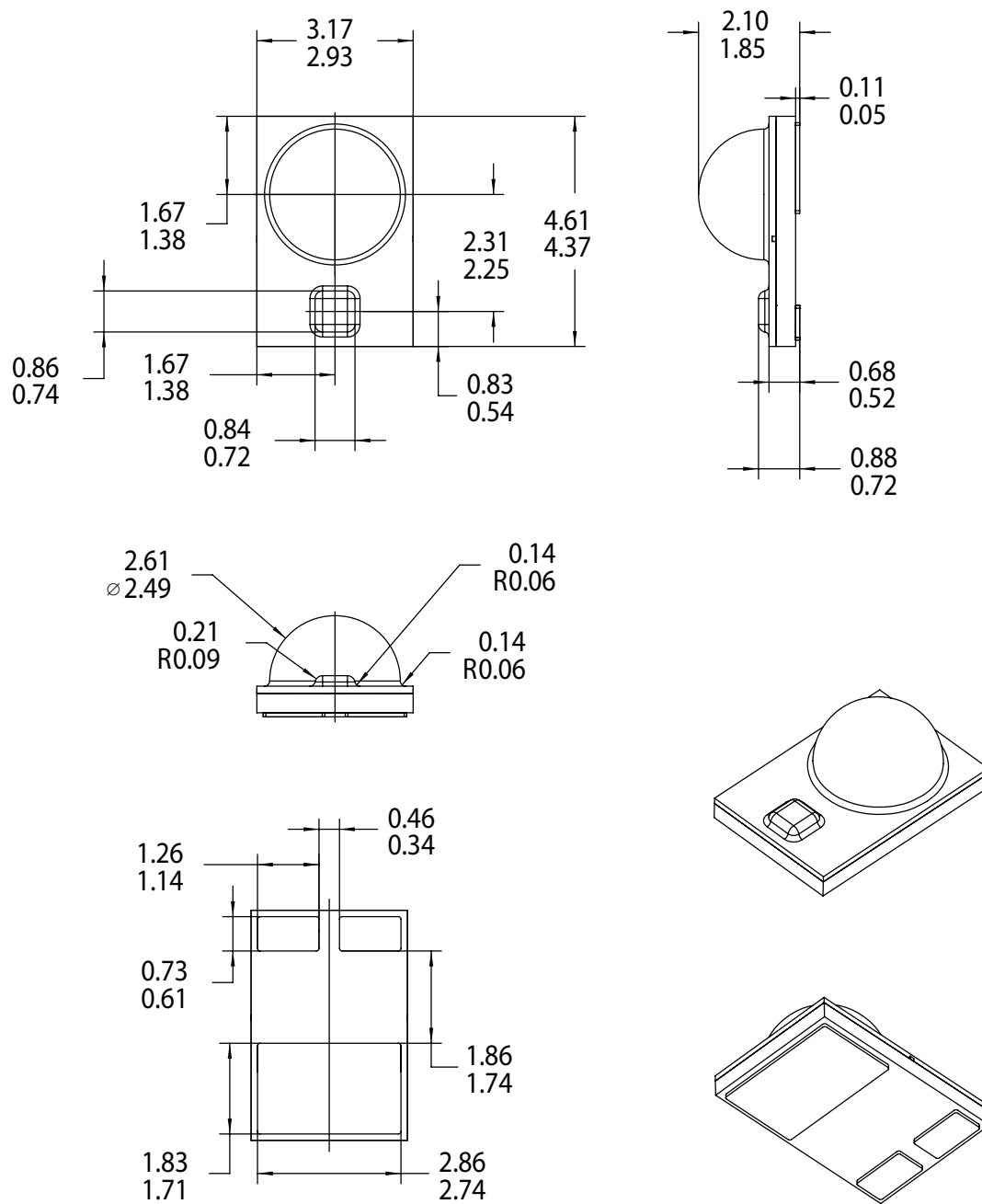

Figure 7b. Mechanical dimensions for LUXEON Rebel ES Blue and LUXEON Rebel ES Royal Blue.

Notes for Figure 7b:

1. Drawings are not to scale.
2. All dimensions are in millimeters.

Reflow Soldering Guidelines

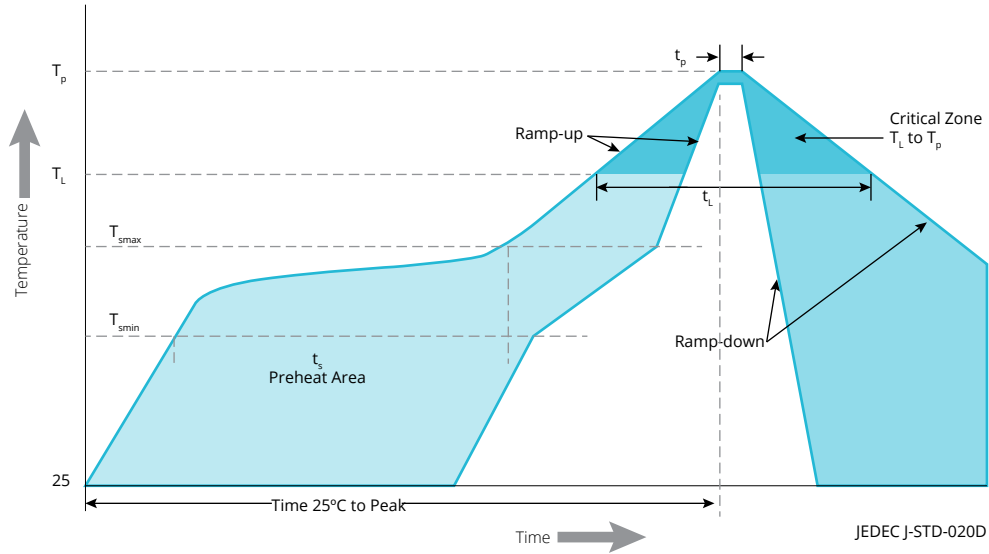

Figure 8. Visualization of the acceptable reflow temperature profile as specified in Table 10.

Table 10. Reflow profile characteristics for LUXEON Rebel Color Line.

PROFILE FEATURE	LEAD-FREE ASSEMBLY
Preheat Minimum Temperature (T_{smin})	150°C
Preheat Maximum Temperature (T_{smax})	200°C
Preheat Time (t_{smin} to t_{smax})	60 to 180 seconds
Ramp-Up Rate (T_L to T_p)	3°C / second maximum
Liquidus Temperature (T_L)	217°C
Time Maintained Above Temperature T_L (t_t)	60 to 150 seconds
Peak / Classification Temperature (T_p)	260°C
Time Within 5°C of Actual Temperature (t_p)	20 to 40 seconds
Ramp-Down Rate (T_p to T_L)	6°C / second maximum
Time 25°C to Peak Temperature	8 minutes maximum

JEDEC Moisture Sensitivity

Table 11. Moisture sensitivity levels for LUXEON Rebel Color Line.

LEVEL	FLOOR LIFE		SOAK REQUIREMENTS STANDARD	
	TIME	CONDITIONS	TIME	CONDITIONS
1	Unlimited	≤30°C / 85% RH	168 Hours +5 / -0	85°C / 85% RH

Solder Pad Design

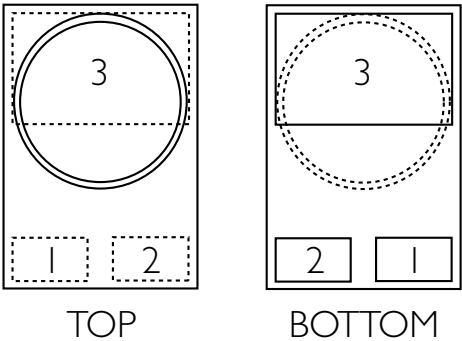

PAD	FUNCTION
1	CATHODE
2	ANODE
3	THERMAL

Figure 9a. LUXEON Rebel Color Line pad configuration.

- Notes for Figure 9a:
- 1. The Thermal Pad is electrically isolated from the Anode and Cathode contact pads.
 - 2. Drawings are not to scale.

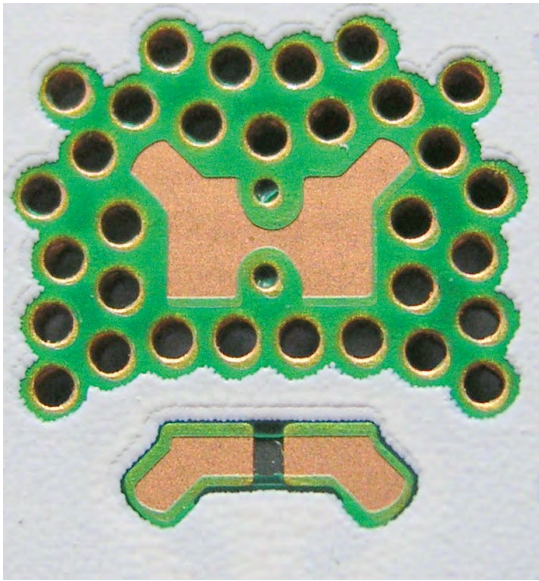
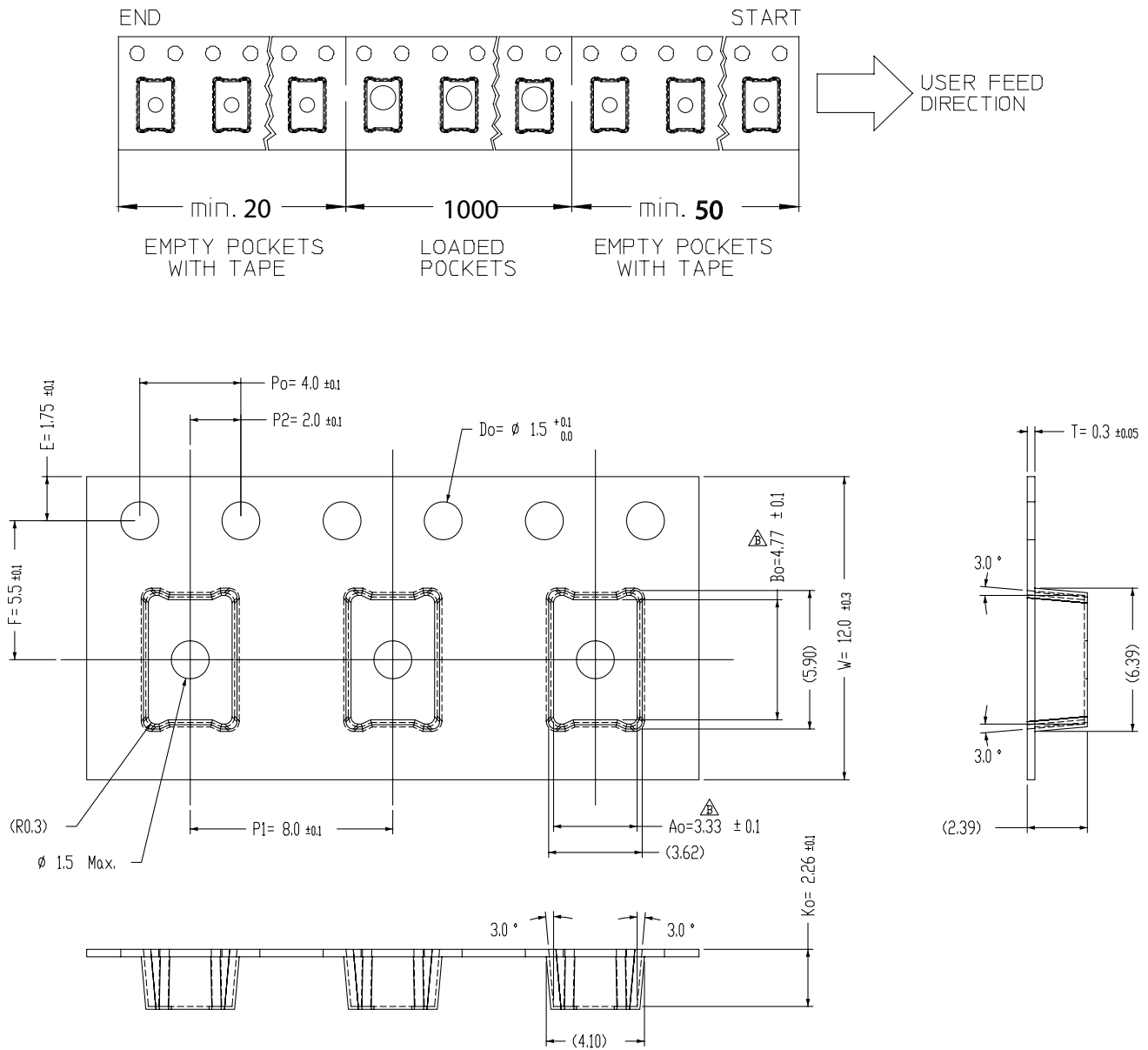

Figure 9b. LUXEON Rebel Color Line solder pad design.

- Notes for Figure 9b:
- 3. The photograph shows the recommended LUXEON Rebel Color Portfolio layout on printed circuit board (PCB). This design easily achieves a thermal resistance of 7K/W.
 - 4. Drawings are not to scale.

Packaging Information

Pocket Tape Dimensions



Notes for Figure 10:

1. Drawings are not to scale.
2. All dimensions are in millimeters.

Reel Dimensions

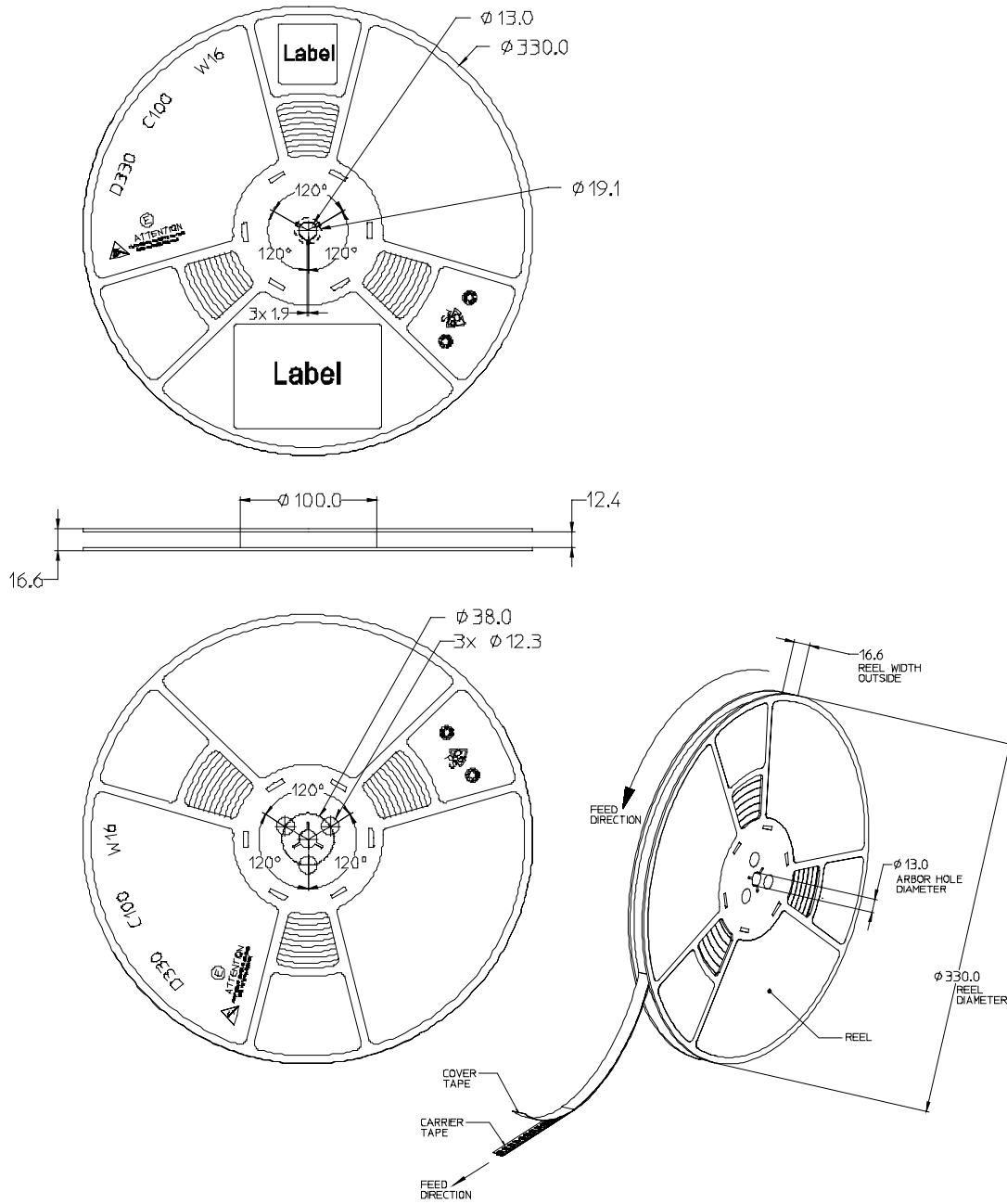

Figure 11. Reel dimensions for LUXEON Rebel Color Line.

Notes for Figure 11:

1. Drawings are not to scale.
2. All dimensions are in millimeters.

About Lumileds

Companies developing automotive, mobile, IoT and illumination lighting applications need a partner who can collaborate with them to push the boundaries of light. With over 100 years of inventions and industry firsts, Lumileds is a global lighting solutions company that helps customers around the world deliver differentiated solutions to gain and maintain a competitive edge. As the inventor of Xenon technology, a pioneer in halogen lighting and the leader in high performance LEDs, Lumileds builds innovation, quality and reliability into its technology, products and every customer engagement. Together with its customers, Lumileds is making the world better, safer, more beautiful—with light.

To learn more about our lighting solutions, visit lumileds.com.



©2022 Lumileds Holding B.V. All rights reserved.
LUXEON is a registered trademark of the Lumileds Holding B.V. in the United States and other countries.

lumileds.com

Neither Lumileds Holding B.V. nor its affiliates shall be liable for any kind of loss of data or any other damages, direct, indirect or consequential, resulting from the use of the provided information and data. Although Lumileds Holding B.V. and/or its affiliates have attempted to provide the most accurate information and data, the materials and services information and data are provided "as is," and neither Lumileds Holding B.V. nor its affiliates warrants or guarantees the contents and correctness of the provided information and data. Lumileds Holding B.V. and its affiliates reserve the right to make changes without notice. You as user agree to this disclaimer and user agreement with the download or use of the provided materials, information and data. A listing of Lumileds product/patent coverage may be accessed at lumileds.com/patents.