

## Modular Jacks

### KLS12-108

#### Materials:

HOUSING : PBT (UL 94V-0)  
PA46 (UL 94V-0)  
PA66 (UL 94V-0)  
CONTACT WIRE : DIAMETER 0.46MM PHOSPHOR BRON GOLD  
PLATING OVER NICKEL  
SHIELD : 0.2-0.25MM THICKNESS BRASS  
WITH NICKEL PLATED

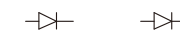
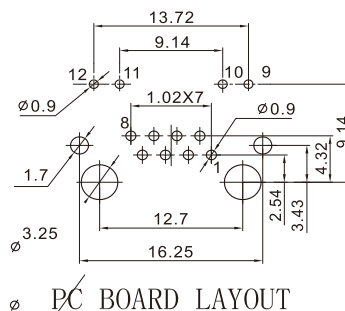
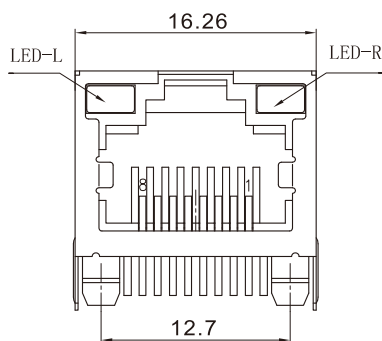
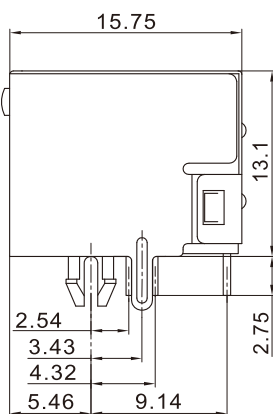
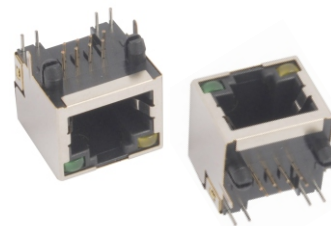

TYPICAL FOR SINGLE  
COLOR LED



TYPICAL FOR  
BL-COLOR LED

CODE	LED-L (LEFT)	LED-R (RIGHT)	CODE	LED-L (LEFT)	LED-R (RIGHT)
0	NO LED	NO LED	A	GREEN/RED (绿/红)	GREEN/RED (绿/红)
1	GREEN (绿色)	YELLOW (黄色)	B	GREEN/YELLOW (绿/黄)	GREEN/YELLOW (绿/黄)
2	YELLOW (黄色)	GREEN (绿色)	C	YELLOW (黄色)	GREEN/ORANGE (绿/橙)
3	GREEN (绿色)	GREEN (绿色)	D	YELLOW (黄色)	GREEN/YELLOW (绿/黄)
4	RED (红色)	GREEN (绿色)	E	GREEN (绿色)	YELLOW/ORANGE (黄/橙)
5	YELLOW (黄色)	YELLOW (黄色)	F	GREEN (绿色)	GREEN/ORANGE (绿/橙)
6	GREEN (绿色)	RED (红色)			

## ORDER INFORMATION

### KLS12-108-8P8C-X-X-X-X

LED STYLE (LED 颜色类型)

W/O EMI (无弹片), W/EMI (带弹片)

FU" 1.5U" 3U"  
6U" 15U" 30U" 50U"

PBT NYLON66 (尼龙66) -NYLON46 (尼龙46)

## Modular Jacks

### KLS12-108

#### Materials:

- HOUSING : PBT (UL 94V-0)  
PA46 (UL 94V-0)  
PA66 (UL 94V-0)
- CONTACT WIRE : DIAMETER 0.46MM PHOSPHOR BRON GOLD  
PLATING OVER NICKEL
- SHIELD : 0.2-0.25MM THICKNESS BRASS  
WITH NICKEL PLATED

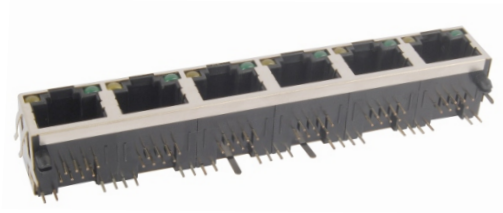

XII

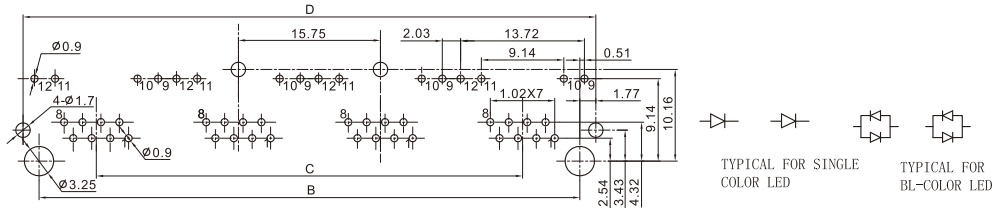
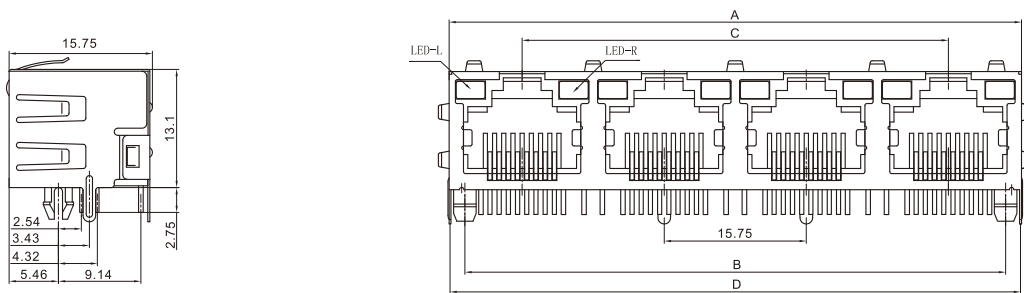

PC BOARD LAYOUT

CODE	LED-L (LEFT)	LED-R (RIGHT)	CODE	LED-L (LEFT)	LED-R (RIGHT)	NO. OF PORTS	DIMENSIONS			
							A	B	C	D
0	NO LED	NO LED	A	GREEN/RED(绿/红)	GREEN/RED(绿/红)					
1	GREEN(绿色)	YELLOW(黄色)	B	GREEN/YELLOW(绿/黄)	GREEN/YELLOW(绿/黄)					
2	YELLOW(黄色)	GREEN(绿色)	C	YELLOW(黄色)	GREEN/ORANGE(绿/橙)					
3	GREEN(绿色)	GREEN(绿色)	D	YELLOW(黄色)	GREEN/YELLOW(绿/黄)	1X2	32.25	28.45	15.75	32
4	RED(红色)	GREEN(绿色)	E	GREEN(绿色)	YELLOW/ORANGE(黄/橙)	1X4	63.75	59.95	47.25	63.5
5	YELLOW(黄色)	YELLOW(黄色)	F	GREEN(绿色)	GREEN/ORANGE(绿/橙)	1X6	95.25	91.45	78.75	95
6	GREEN(绿色)	RED(红色)				1X8	126.75	122.95	110.25	126.5

## ORDER INFORMATION

### KLS12-108-1XN-8PXC-X-X-X-X-X

