

## Data sheet

Commercial Art.No.: 25.197.0553.0

Printed circuit board terminal 8893 / 5 OB

PCB terminal with screw connection with rising cage clamp system, 5 poles, with solder pin (3.5mm), max. cross section: 1.5 mm<sup>2</sup>, pitch: 3.81 mm, type of packing: carton, color: grey

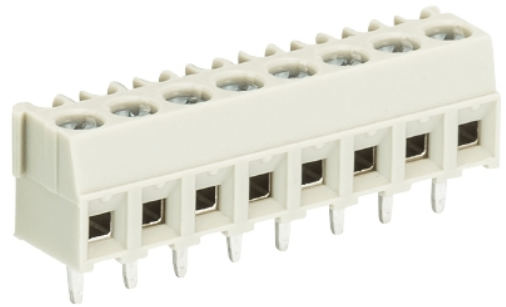

Commercial Art.No.	25.197.0553.0
EAN	4015573317031
Order Unit	50

Certificates / Approvals



## Technical data

### General

Modular spacing	3.81 mm
Connection type	screw connection
Soldering process	Wave soldering
Packaging	Carton
Number of poles	5
Conductor to circuit board	180°
Number of levels	1
Integrated test socket	yes
Insulation plate	No
Retaining pins	No
Marking	No

### Technical data

Nominal cross section	1 mm <sup>2</sup>
Rated current	10 A
Overtoltage Category I	690 V
Overtoltage Category II	250 V
Overtoltage Category III	160
Rated impulse voltage	2.5 kV
Wire strip length	5 mm

### Connection Data

Minimum cross section solid	0.14 mm <sup>2</sup>
-----------------------------	----------------------

Maximum cross section solid	1.5 mm <sup>2</sup>
Minimum cross section fine stranded	0.14 mm <sup>2</sup>
Maximum cross section fine stranded	1 mm <sup>2</sup>
Wire strip length	5 mm

**Technical Data UL/CSA**

Cross section UL	30-16 AWG
Voltage UL	300 V
Current field wiring	10 A
Current factory wiring	10 A
Cross section CSA	30-16 AWG
Voltage CSA	300 V
Current CSA	10 A

**Other**

Type of insulation material	Thermoplastic
Color	Grey
Height	8.5 mm
Length	19.05 mm
Depth	7.2 mm
Material attachment screw	Steel
Material contact base	CuSn
Material contact surface	Sn

**Classification**

ECLASS 11	
ECLASS 8.1	27440401
ETIM 7.0	EC002643
ETIM 6.0	EC002643
ETIM 5.0	EC002643
ETIM 4.0	EC002643

**Product compliance**

ROHS conformity status	Compliant/Exempted
ROHS exceptions	III-6(c)
REACH-SVHC conformity status	Duty-To-Declare
REACH-SVHC substances	Lead
REACH-SVHC CAS numbers	7439-92-1

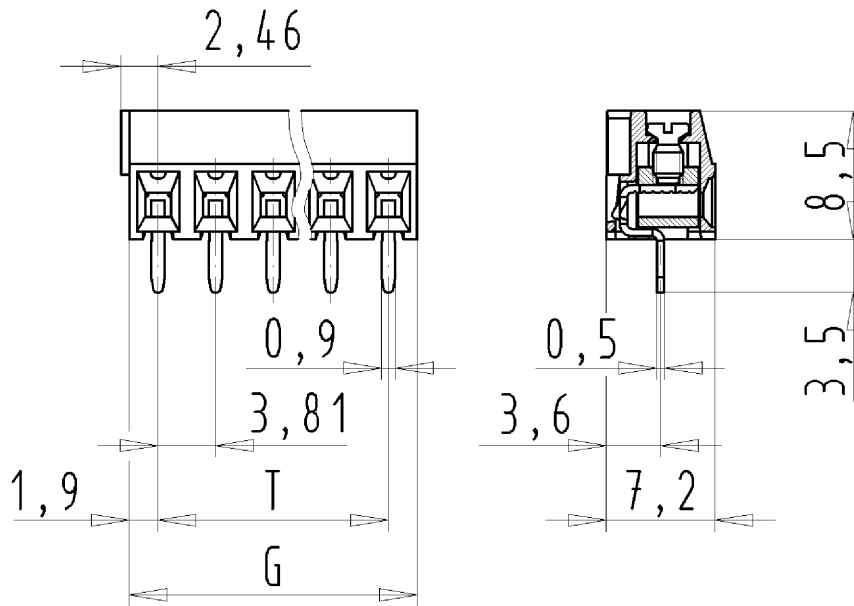

für folgende Tabellen-Zchnng.  
 25.197.0253.0 8893/.. OB

LP.KLEMME  
 25.197.0253.0 10W  
 08.11.2007 DÜT  
 M 2:1