

## DETAILS

<b>Product Number</b>	F13660_ANGELINA-M-B
<b>Family</b>	ANGELINA
<b>Type</b>	Reflector
<b>Color</b>	metal
<b>Diameter</b>	82 mm
<b>Height</b>	31 mm
<b>Style</b>	round
<b>Optic Material</b>	PC
<b>Holder Material</b>	
<b>Fastening</b>	
<b>Status</b>	production ready
<b>ROHS Compliant</b>	Yes
<b>Date Updated</b>	12/04/2017



## OPTICAL PROPERTIES

LED	Viewing	Light	Effi-		Connector
	Angle	Beam	ciency	cd/lm	
BXRA ES Rectangle	38 deg	Medium	92 %	1.320	BJB: 47.319.2040
V18 Gen6	44 deg	Medium	93 %	1.100	BJB: 47.319.2274
V15 Gen6	41 deg	Medium	93 %	1.200	BJB: 47.319.2224
V18 Gen7	44 deg	Medium	93 %	1.100	BJB: 47.319.2350
CLL04x/CLU04x	sim: 37	Medium	sim: 95 %	sim: 1.600	BJB: 47.319.2030
CLL03x/CLU03x	37 deg	Medium	92 %	1.400	BJB: 47.319.2021
CLL03x/CLU03x	39 deg	Medium	94 %	1.220	A.A.G. STUCCHI: 8101/G2
CLL04x/CLU04x	39 deg	Medium	94 %	1.200	A.A.G. STUCCHI: 8102/G2
CLU730/731	sim: 37	Medium	sim: 91 %	sim: 1.570	BJB: 47.319.2030
CLU720/721	35 deg	Medium	94 %	1.300	A.A.G. STUCCHI: 8101/G2
CLU720/721	34 deg	Medium	94 %	1.400	BJB: 47.319.2021
CXA/B 30xx	45 deg	Medium	92 %	1.070	A.A.G. STUCCHI: 8404/G2
CXA/B 25xx	42 deg	Medium	93 %	1.140	A.A.G. STUCCHI: 8401/G2
CXA/B 25xx	44 deg	Medium	92 %	1.100	BJB: 47.319.2141
COB 10W/13W/17W/24W	38 deg	Medium	93 %	1.300	BJB: 47.319.2080
COB 10W/13W/17W/24W	37 deg	Medium	94 %	1.280	A.A.G. STUCCHI: 8600/G2
COB 40W/60W	46 deg	Medium	91 %	1.050	A.A.G. STUCCHI: 8102/G2
LUXEON K16	44 deg	Medium	94 %	1.100	BJB: 47.319.2070
LUXEON K12	sim: 29	Medium	-	-	BJB: 47.319.2070
LUXEON CoB 1204/1205	38 deg	Medium	94 %	1.260	A.A.G. STUCCHI: 8301/G2
LUXEON CoB 1208	39 deg	Medium	94 %	1.230	A.A.G. STUCCHI: 8301/G2
LUXEON CoB 1211	43 deg	Medium	92 %	1.130	A.A.G. STUCCHI: 8102/G2
LUXEON CoB 1211	44 deg	Medium	92 %	1.100	BJB: 47.319.2030
LUXEON CoB 1216	49 deg	Medium	91 %	1.000	BJB: 47.319.2030
CXM-22	48 deg	Medium	92 %	1.000	BJB: 47.319.2030

## OPTICAL PROPERTIES

LED	Viewing Angle	Light Beam	Effi- ciency	cd/lm	Connector
CXM-14	40 deg	Medium	94 %	1.300	BJB: 47.319.2021
Soleriq E30	42 deg	Medium	90 %	1.190	BJB: 47.319.2090
Soleriq S13	37 deg	Medium	94 %	1.270	A.A.G. STUCCHI: 8502/G2
Soleriq S19	41 deg	Medium	94 %	1.170	BJB: 47.319.2170
Soleriq S19	41 deg	Medium	93 %	1.200	A.A.G. STUCCHI: 8503/G2
Soleriq P13	39 deg	Medium	94 %	1.230	A.A.G. STUCCHI: 8502/G2
Soleriq S13 Gen2	37 deg	Medium	93 %	0.920	BJB: 47.319.2021
COB D Series LES 22 mm	sim: 41	Medium	sim: 90 %	sim: 1.270	BJB: 47.319.2030
COB D Series LES 14.5 mm	41 deg	Medium	93 %	1.170	A.A.G. STUCCHI: 8101/G2
COB D Series LES 14.5 mm	41 deg	Medium	93 %	1.170	BJB: 47.319.2021
ZC12/18	39 deg	Medium	93 %	1.230	A.A.G. STUCCHI: 8101/G2
ZC25/40	47 deg	Medium	92 %	1.030	A.A.G. STUCCHI: 8102/G2
Mega Zenigata (GW6DME)	40 deg	Medium	94 %	1.210	A.A.G. STUCCHI: 8301/G2
STARK SLE PURE G3 LES17	41 deg	Medium	94 %	1.170	A.A.G. STUCCHI: 8101/G2
SLE G4 LES23 H	42 deg	Medium	92 %	1.200	-
SLE G4 LES19 H	37 deg	Medium	92 %	1.300	-
SLE G5 LES15	38 deg	Medium	94 %	1.260	BJB: 47.319.2021
SLE G5 LES19 H	37 deg	Medium	91 %	1.270	-
SLE G5 LES23 H	42 deg	Medium	92 %	1.150	-
SLE G6 LES19 H	sim: 34	Medium	sim: 91 %	sim: 1.620	-
SLE G6 LES23 H	sim: 36	Medium	sim: 90 %	sim: 1.510	-
SLE G6 LES17 H	sim: 32	Medium	sim: 91 %	sim: 1.800	-
SLE G6 LES15 H D50	sim: 35	Medium	sim: 91 %	sim: 1.560	-

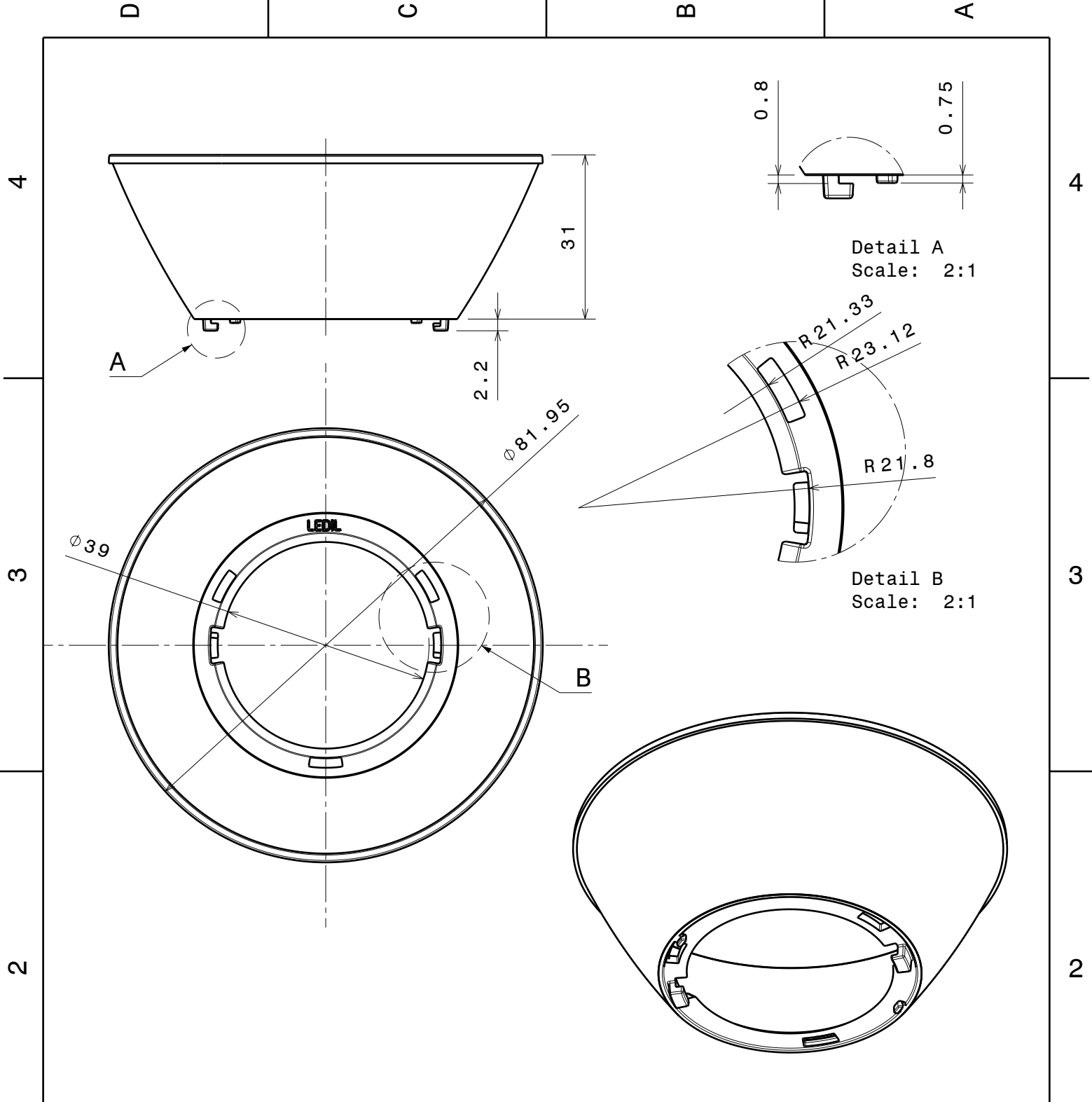

INDEX	PART NO	DESCRIPTION	MATERIAL	COLOUR
1		ANGELINA-B	PC	metal

Tolerances if not otherwise shown  
 According to DIN ISO 2768-1  
 Linear measures:  
 Up to 30mm class M, otherwise class C.  
 According to DIN ISO 2768-2  
 Form and position: class L

**LEDiL** Ledil Oy  
 Salorankatu 10  
 FIN 24240 SALO  
 Finland

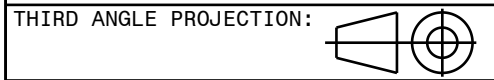

DRAWING TITLE  
**ANGELINA-B series Reflector**

This drawing is the property of LEDiL Oy. It may not be reproduced, copied or communicated without a written agreement with LEDiL Oy."

SIZE	PART NUMBER
A4	-

SCALE	1:1	WEIGHT	-	SHEET	1/1
-------	-----	--------	---	-------	-----

Luminaire: LEDiL Oy C13660\_ANGELINA-M-B\_(BXRA\_ES) Eff. 92%  
Lamps: 1 x Bridgelux BXRA\_ÉS\_(QQ40\_BXRA-W1202\_1019A-2010) 268lm@250mA\_P=3.36W\_I=250mA

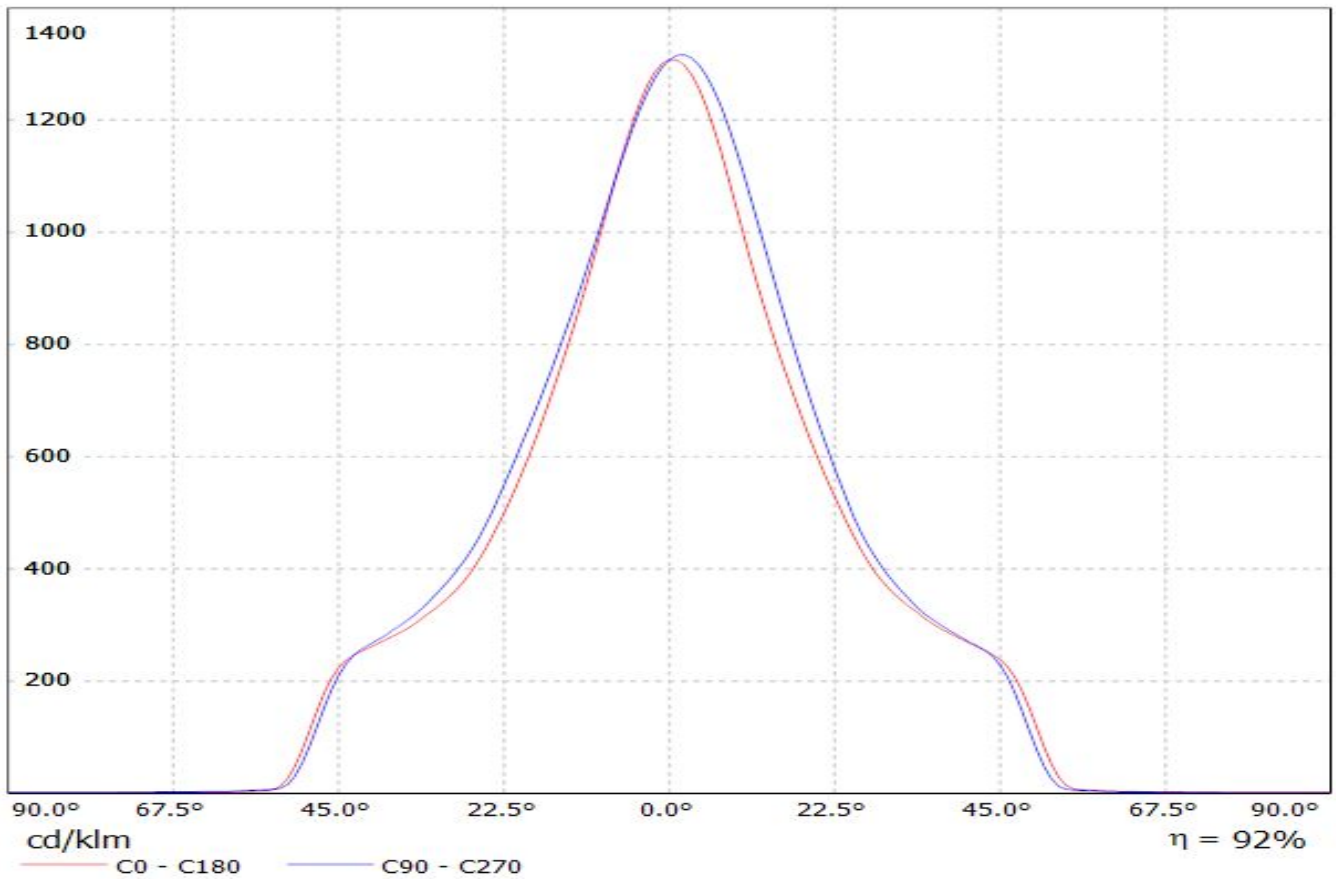

Luminaire: Ledil F13660\_ANGELINA-M-B\_(V18+BJB)  
Lamps: 1 x Bridgelux\_V18\_(BXRC-30E4000-F-23)  
\_+47.319.2274\_1094.62lm@250mA\_CCT=3000K\_P=6.875W\_I=0.25A

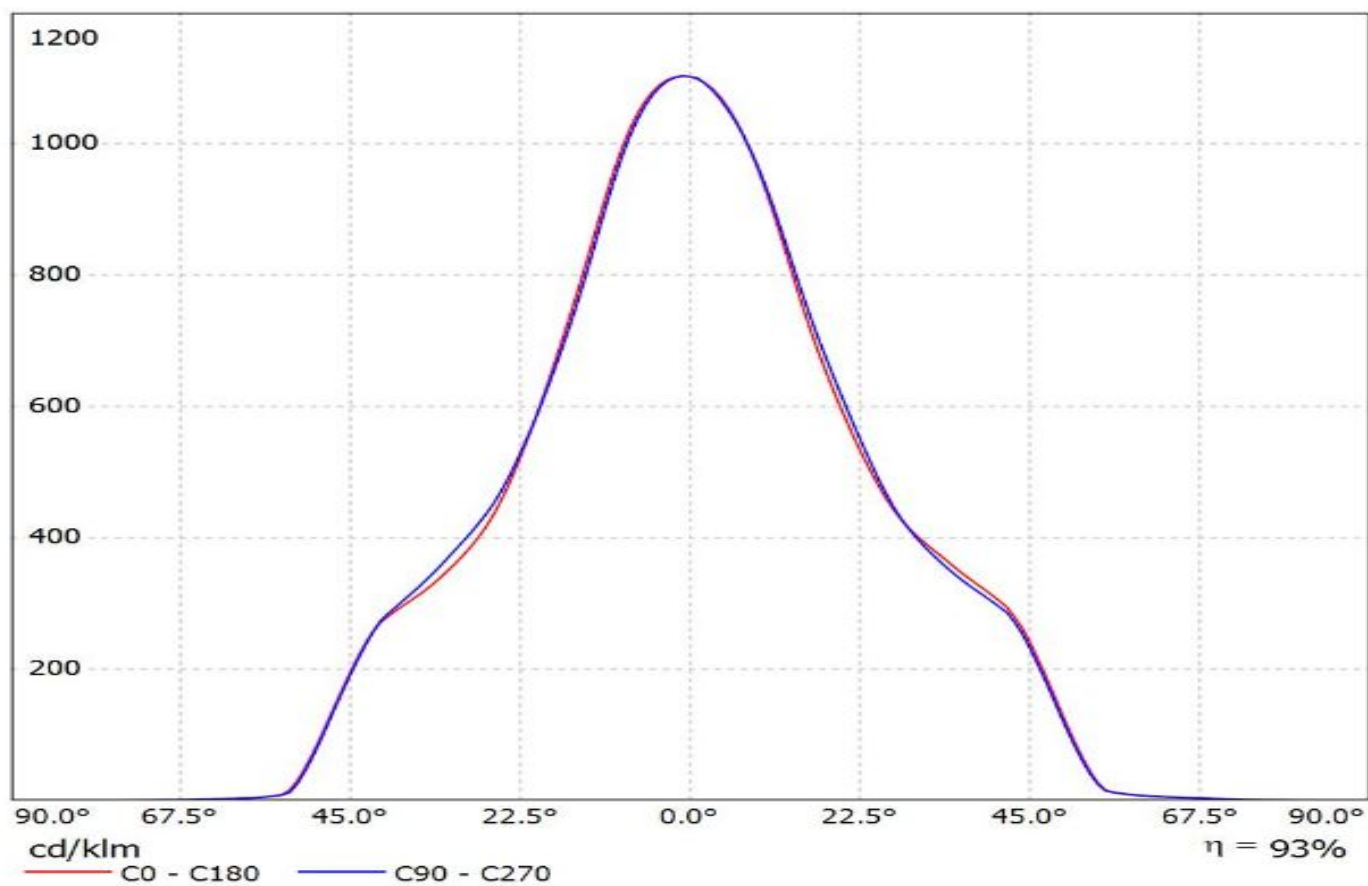

Luminaire: Ledil F13660\_ANGELINA-M-B\_(V15+BJB)

Lamps: 1 x Bridgelux\_V15\_+47.319.2224\_1096.43lm@250mA\_P=8.2647W\_I=0.25A

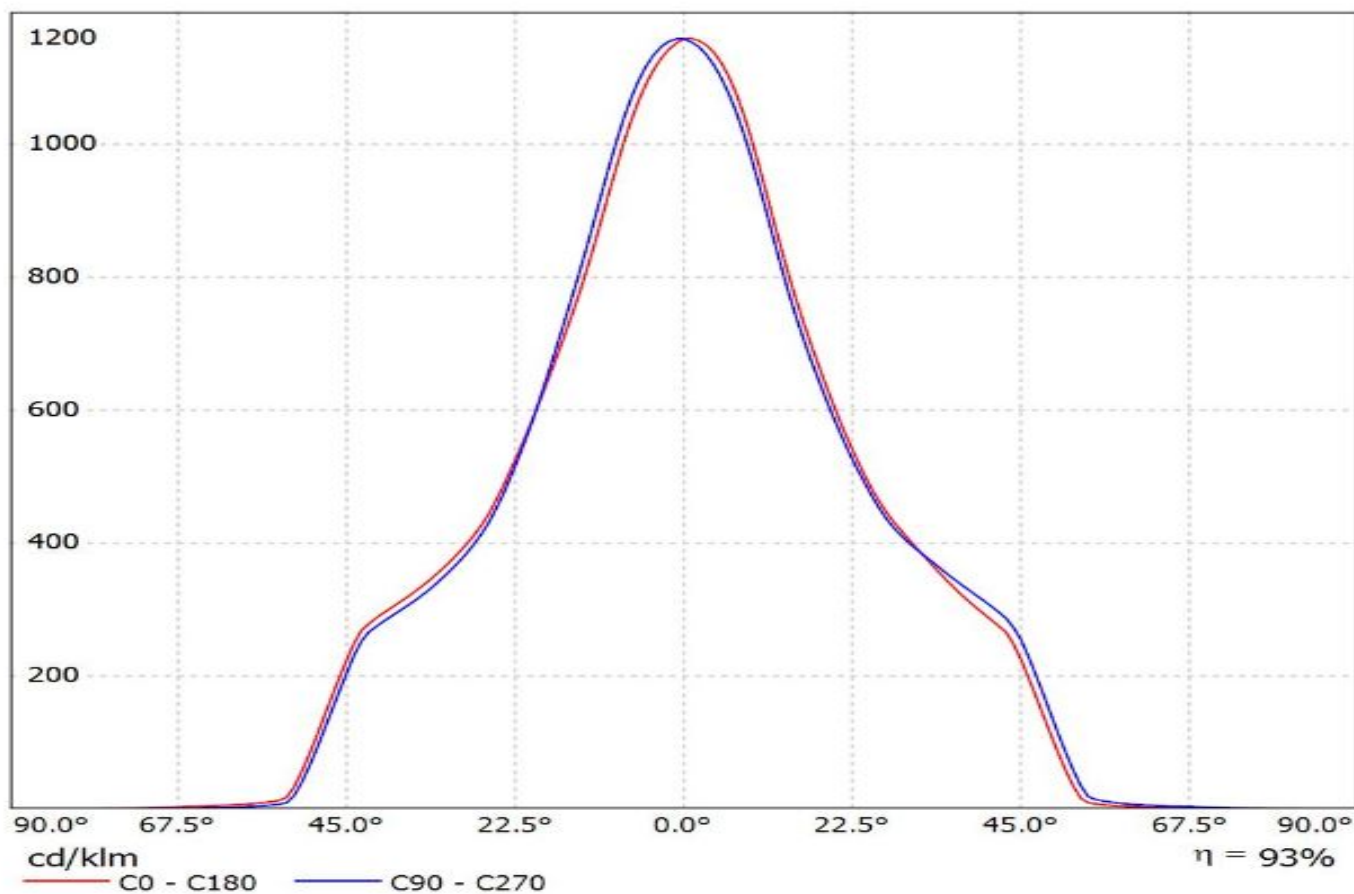

Luminaire: LEDiL Oy F13660\_ANGELINA-M-B\_(V18\_Gen7)+BJB

Lamps: 1 x Bridgelux\_V18\_Gen7\_(BXRE-30E4000-B)+BJB\_47.319.2350\_1384.73lm@250mA\_P=8.09577W\_I=0.25A

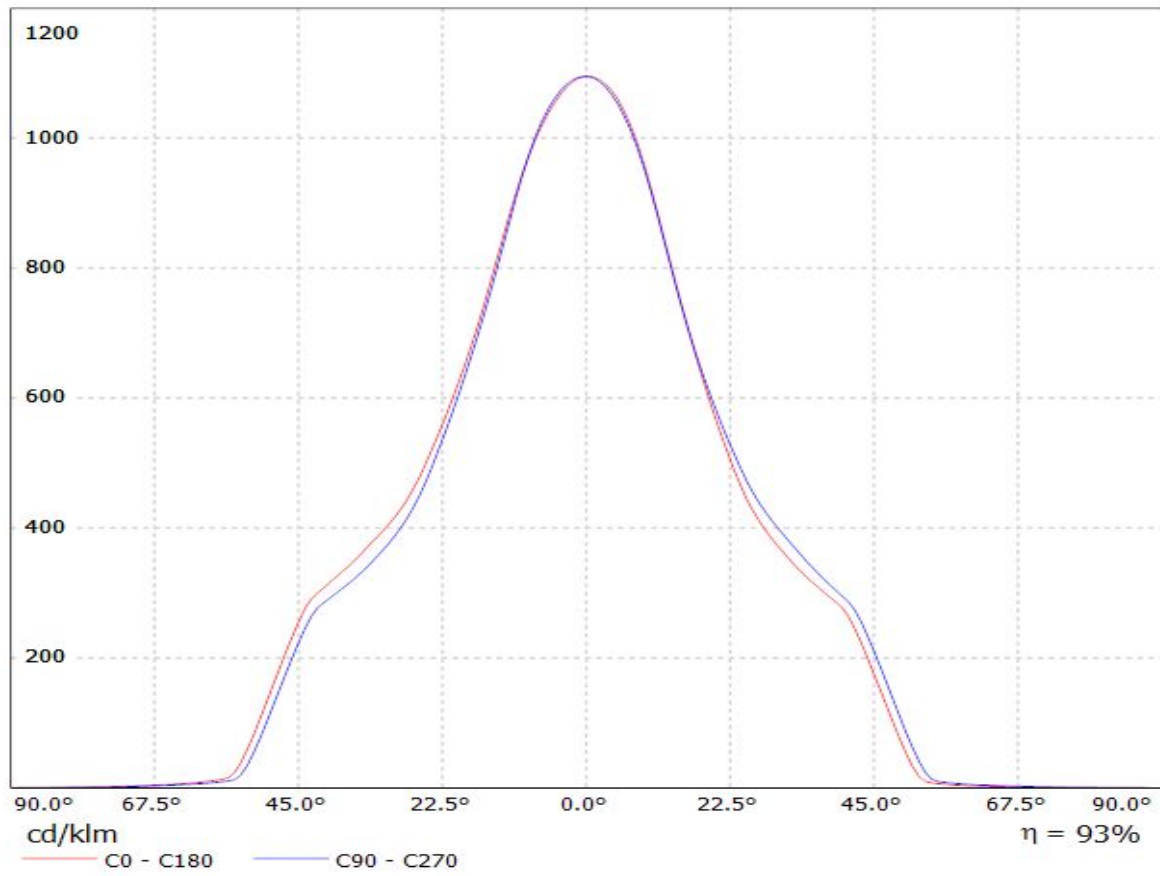

# LEDiL Oy C13660\_ANGELINA-M-B\_(CLL030) Eff.91.7% / LDC (Linear)

Luminaire: LEDiL Oy C13660\_ANGELINA-M-B\_(CLL030) Eff.91.7%

Lamps: 1 x CITIZEN\_CLL030\_(CLL030-1205A5-303H1A7) 797.292lm@250mA CCT=3000K P=8.65307W I=249.8mA

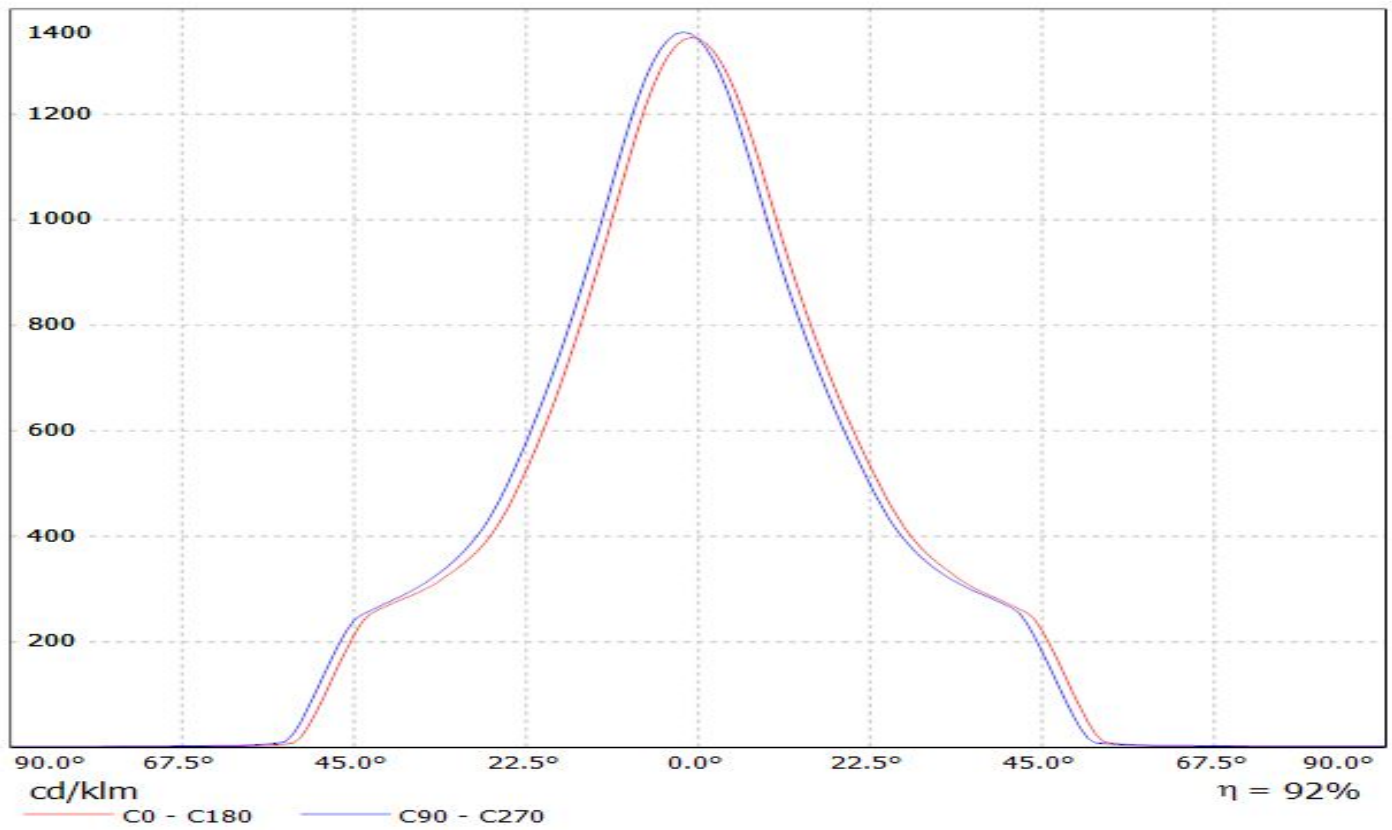



Luminaire: LEDiL Oy F13660\_ANGELINA-M-B\_(CLU034)

Lamps: 1 x Citizen\_CLU034\_(CLU034-1205B8-303M1A2)\_1159.11lm@250mA\_P=8.46586W\_I=249.9mA

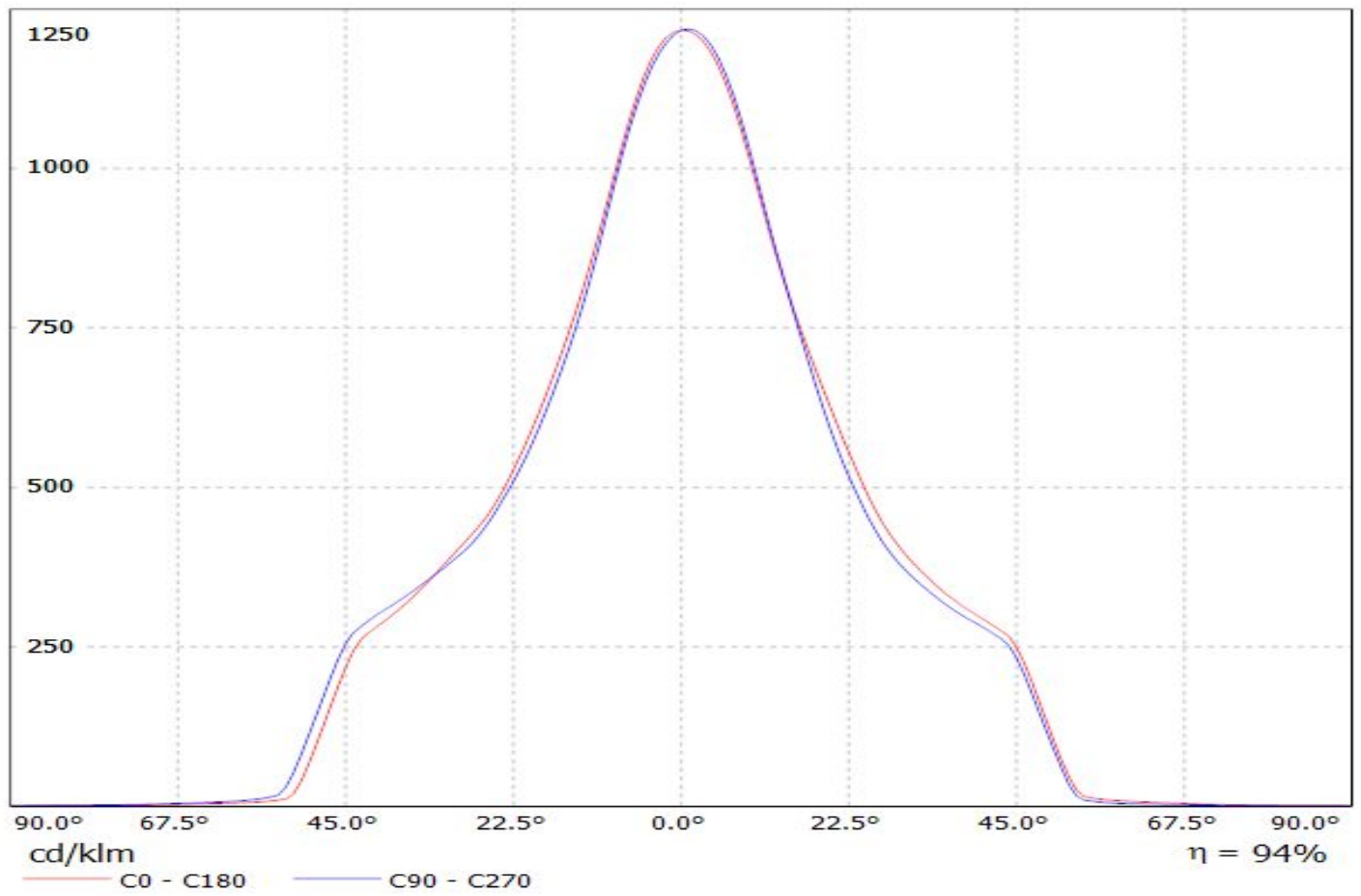

Luminaire: LEDiL Oy F13660\_ANGELINA-M-B\_(CLU044)

Lamps: 1 x Citizen\_CLU044\_(CLU044-1212B8-303M1A2)\_1300.9lm@250mA\_P=8.14849W\_I=249.9mA

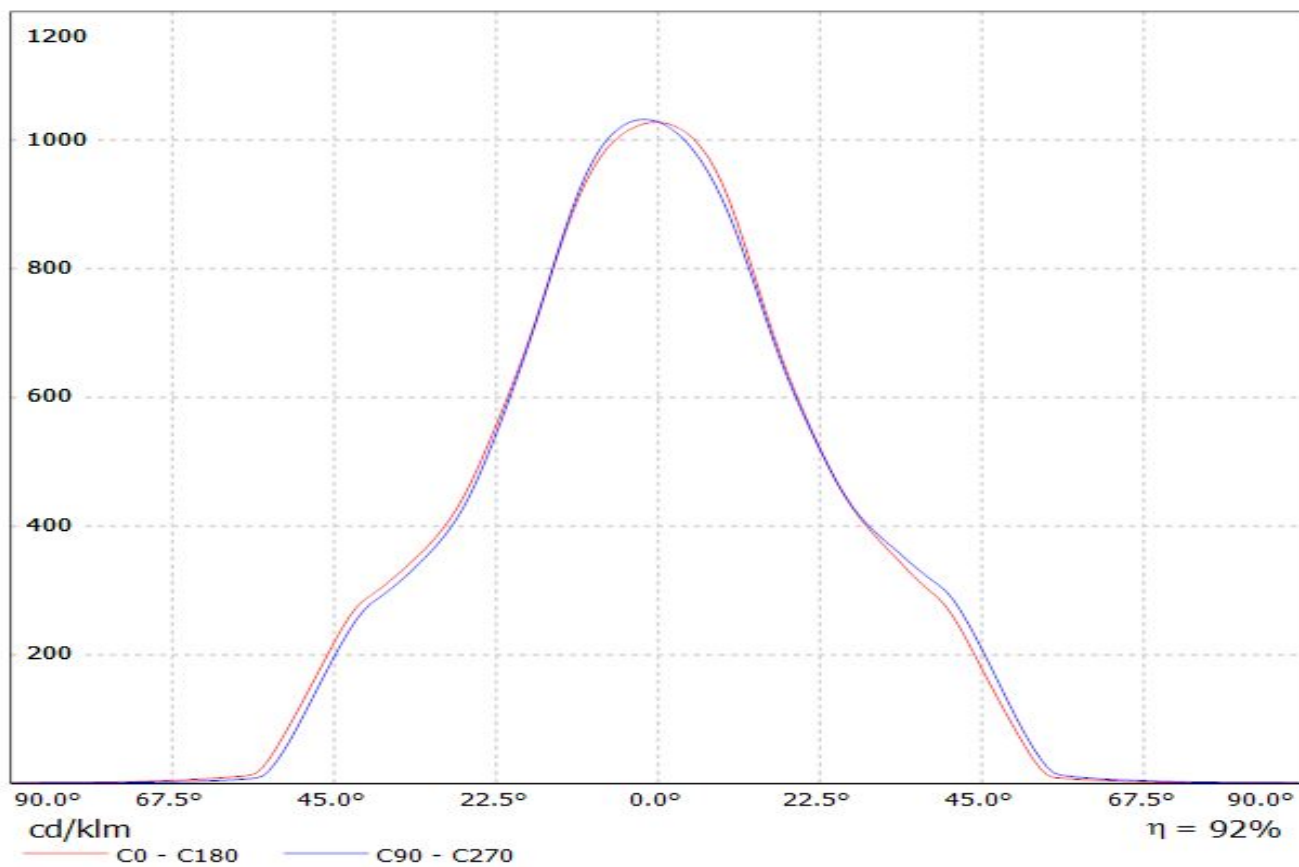

Luminaire: Ledil F13660\_ANGELINA-M-B\_(CITIZEN\_CLU720)  
Lamps: 1 x CITIZEN\_CLU720\_(CLU720-1206B8-273M2)  
\_1320.42lm@250mA\_CCT=2700K\_P=8.35W\_I=0.25A

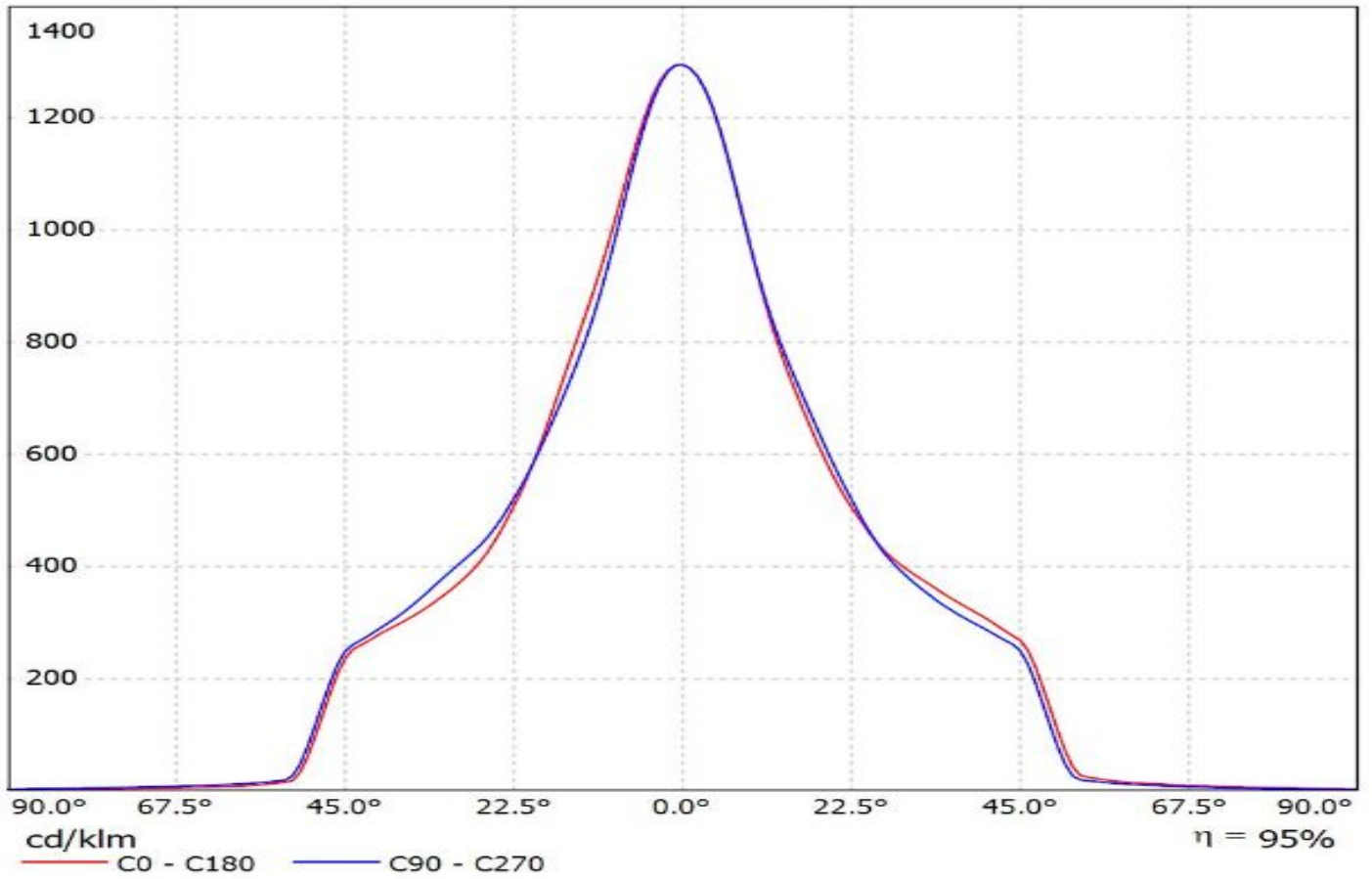

Luminaire: LEDiL Oy F13660\_ANGELINA-M-B\_(CITIZEN\_CLU720)  
Lamps: 1 x CITIZEN\_CLU720\_(BJB: 47.319.2020)\_1214.68lm@250mA\_CCT=2700K\_P=8.31842W\_I=0.25A

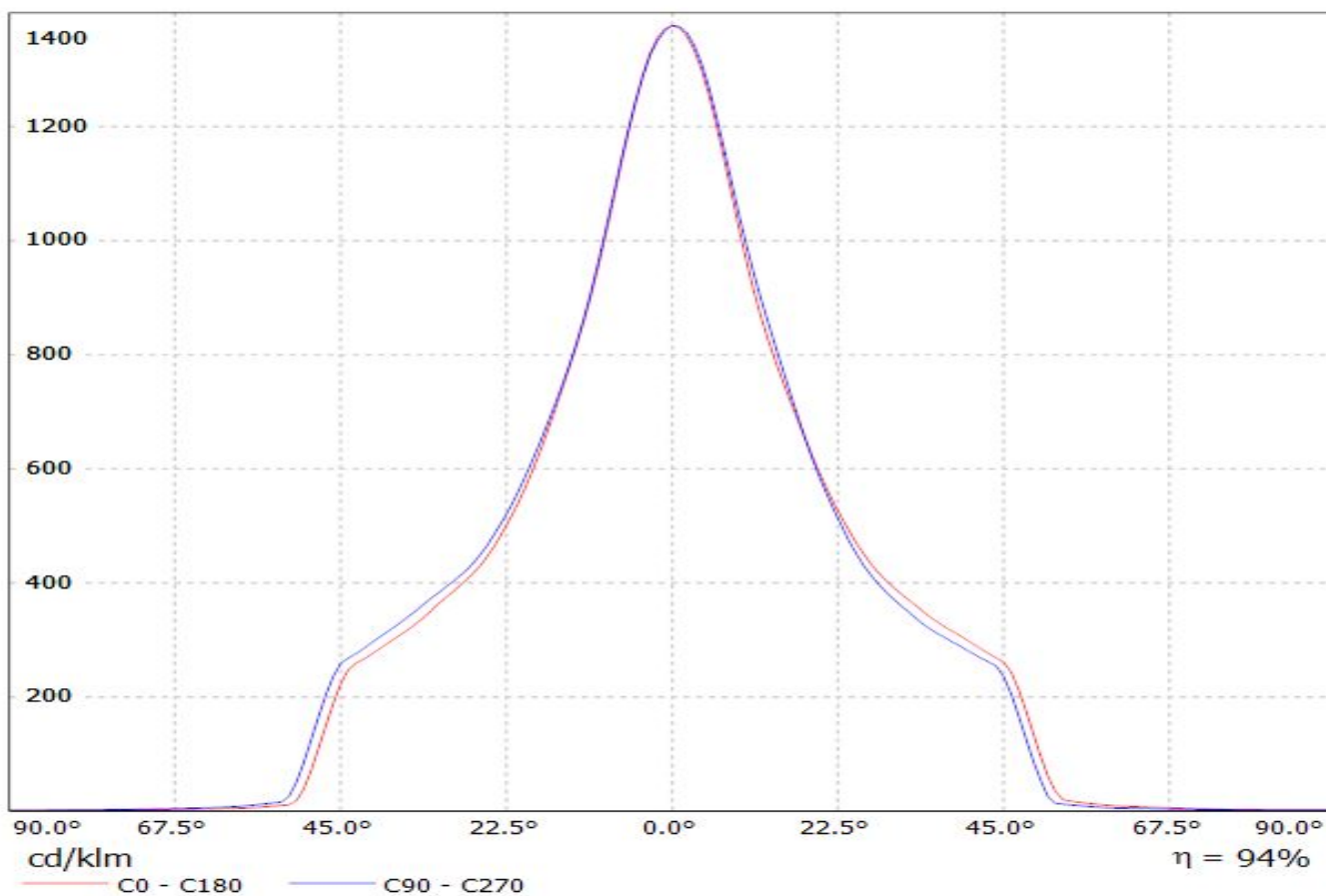

Luminaire: LEDiL Oy F13660\_ANGELINA-M-B\_(CXA30)

Lamps: 1 x Cree\_CXA30\_(CXA3050-3C0-Y2-N0H)\_1395.36lm@250mA\_P=8.20318W\_I=249.8mA

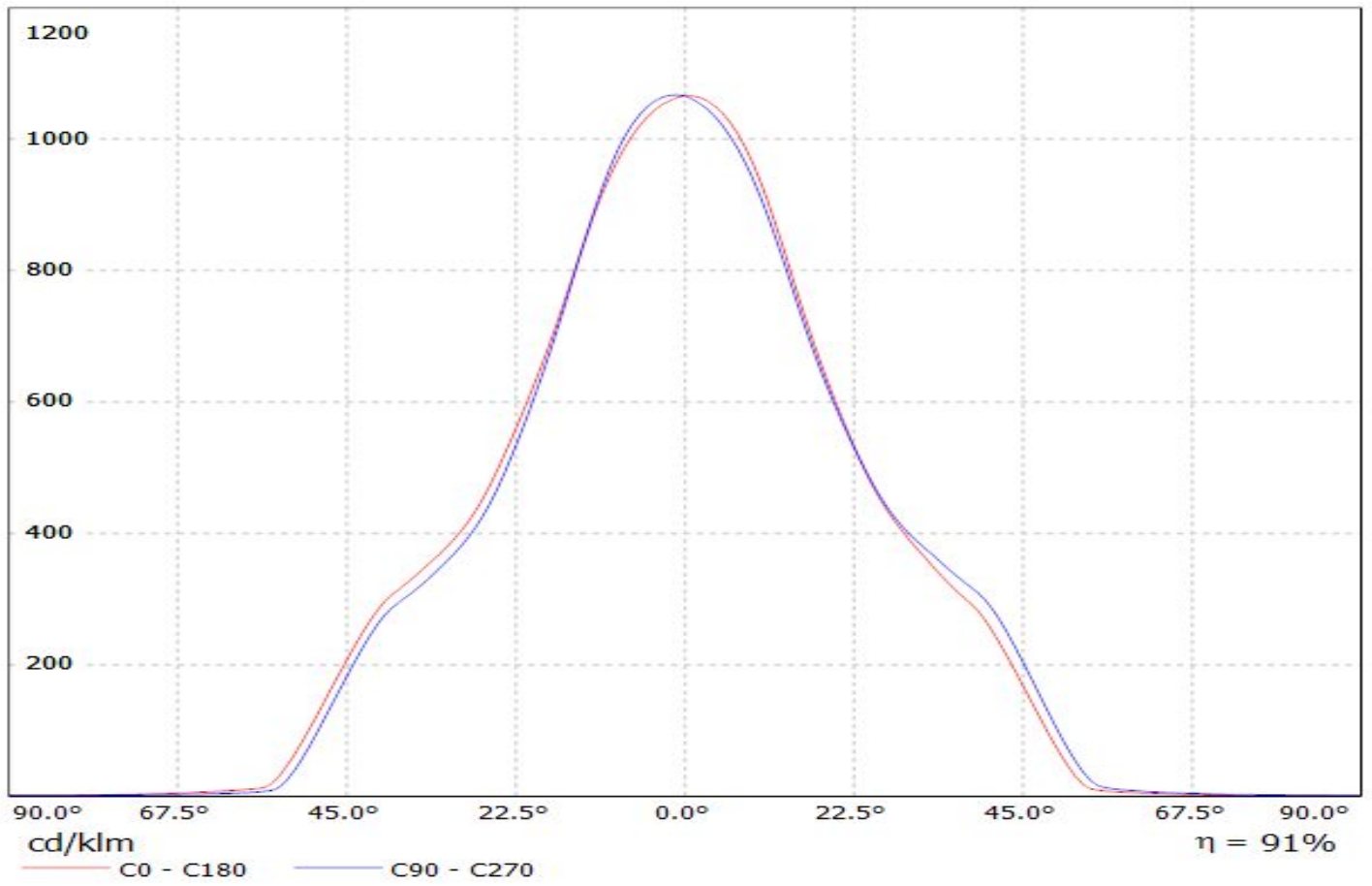

Luminaire: LEDiL Oy F13660\_ANGELINA-M-B\_(CXA2590)  
Lamps: 1 x CREE\_CXA2590\_(CXA2590-30F-Z4-RPH-00001)  
\_837.275lm@100mA\_CCT=3000K\_P=6.36316W\_I=100.1mA

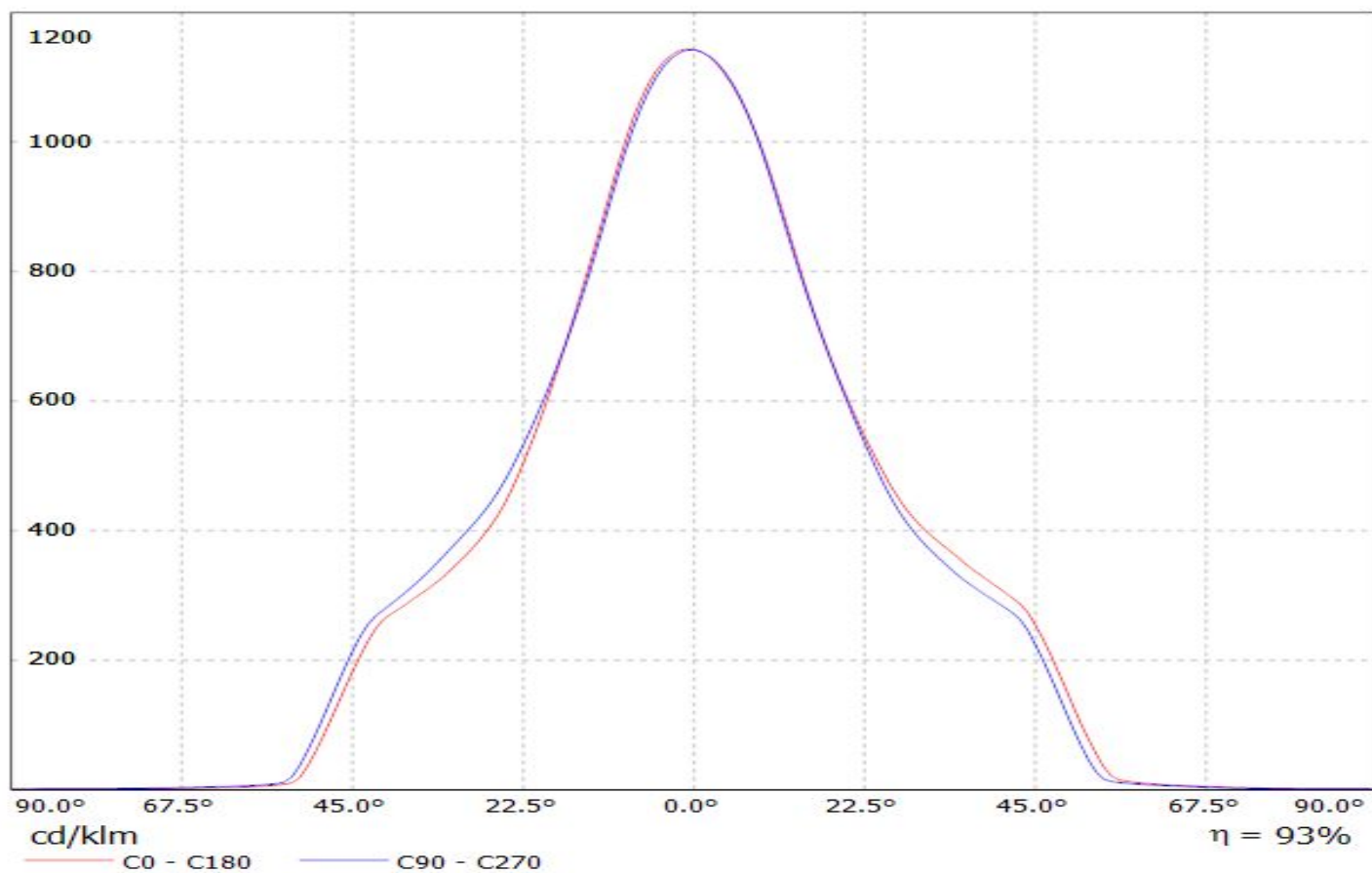

Luminaire: Ledil F13660\_ANGELINA-M-B (CXB2540\_+\_BJB\_47.319.2140)  
Lamps: 1 x CREE\_CXB2540 (-40G-W4-N0H-00002)  
+\_BJB\_47.319.2140\_1412.99lm@250mA\_CCT=40000K\_P=8.1310W\_I=0.25A

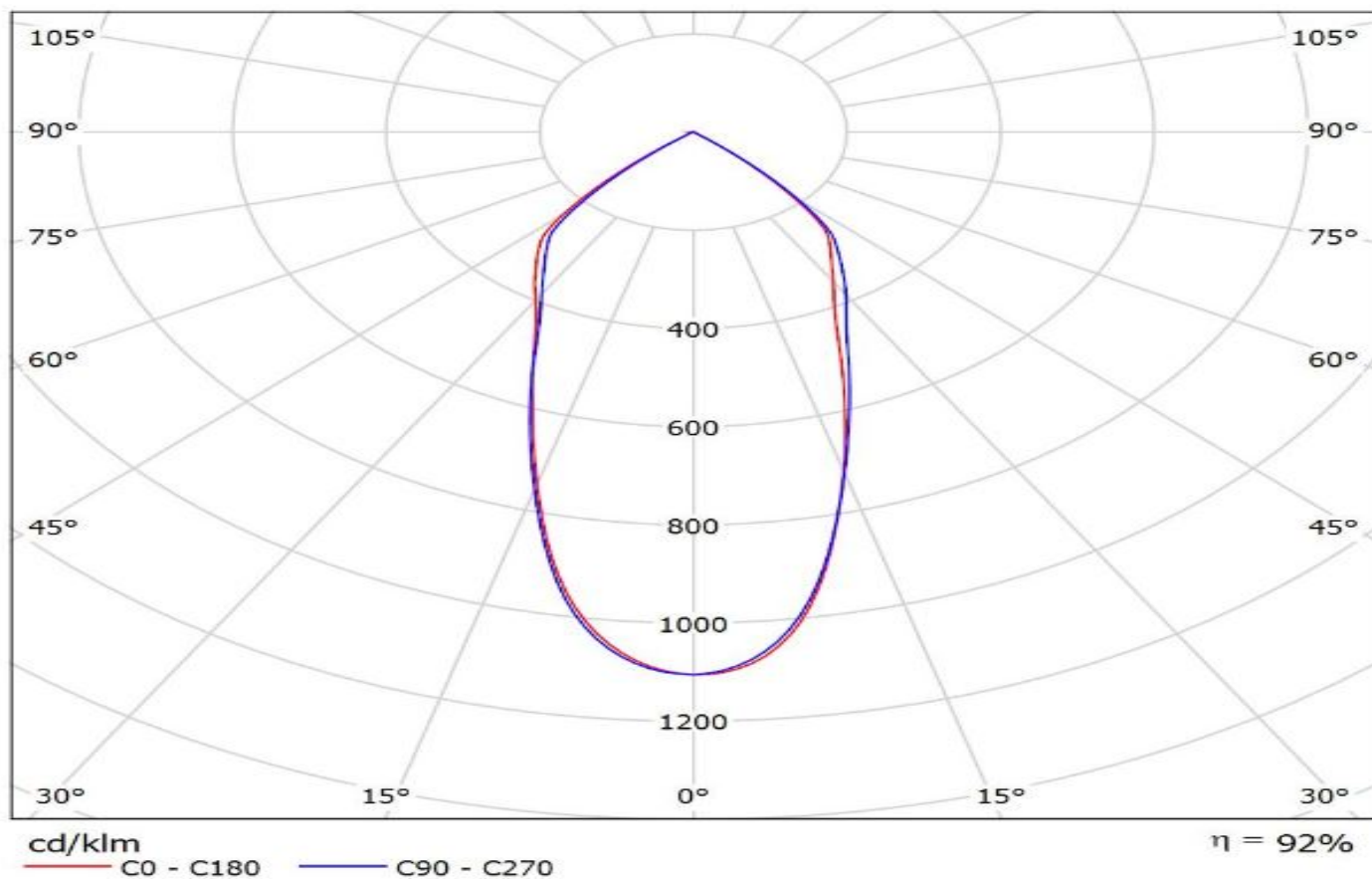

Ledil F13660\_ANGELINA-M-B\_(COB\_10W)\_(BJB\_47\_319\_2080) / LDC  
(Linear)

Luminaire: Ledil F13660\_ANGELINA-M-B\_(COB\_10W)\_(BJB\_47\_319\_2080)  
Lamps: 1 x LG\_COB\_10W\_(LEMWWM18580LG00)\_(BJB\_47\_319\_2080)  
\_947.453lm@250mA\_P=9.342W\_I=0.250A

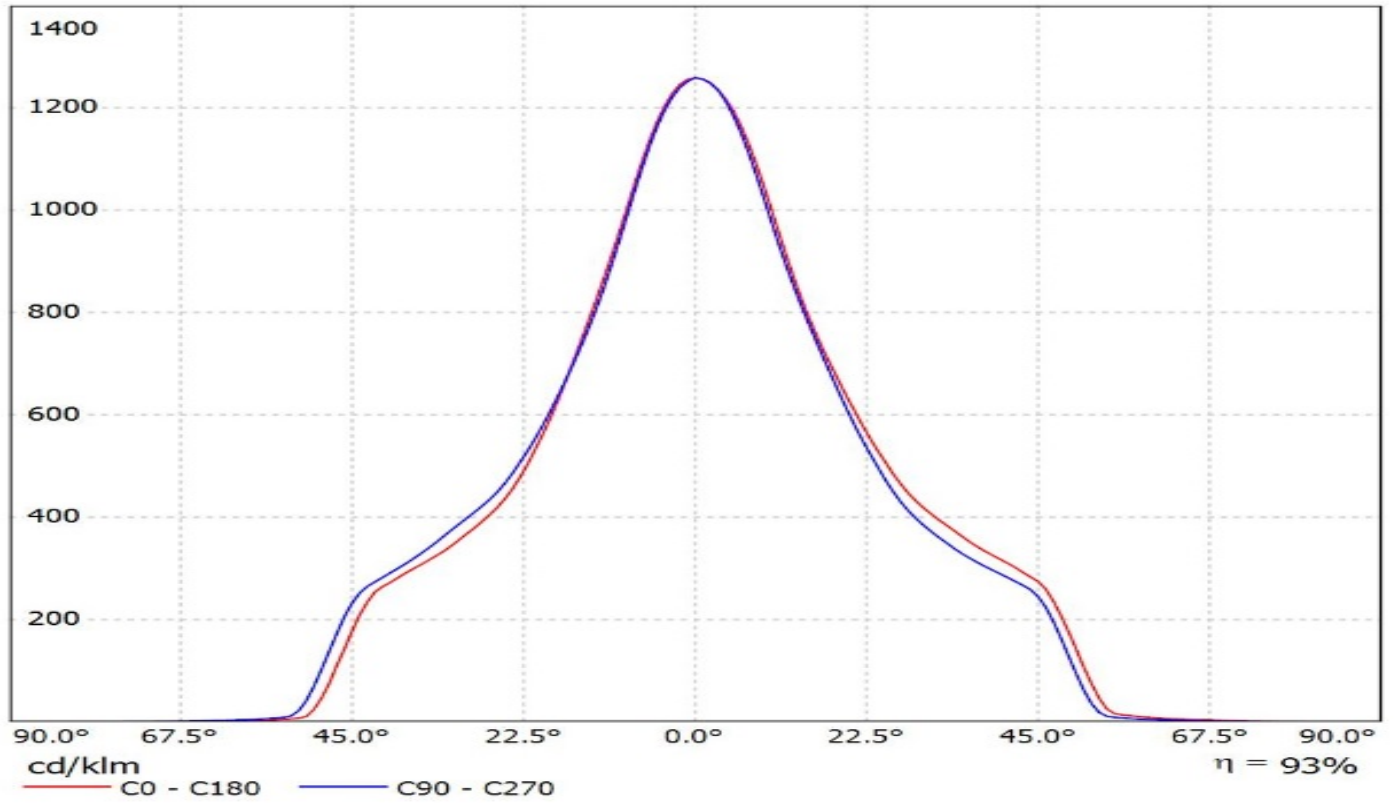



Luminaire: LEDiL Oy F13660\_ANGELINA-M-B\_(LG\_COB\_10W)

Lamps: 1 x LG\_COB\_10W\_(LEMWM18580LG00)\_917.757lm@250mA\_P=9.31304W\_I=249.8mA

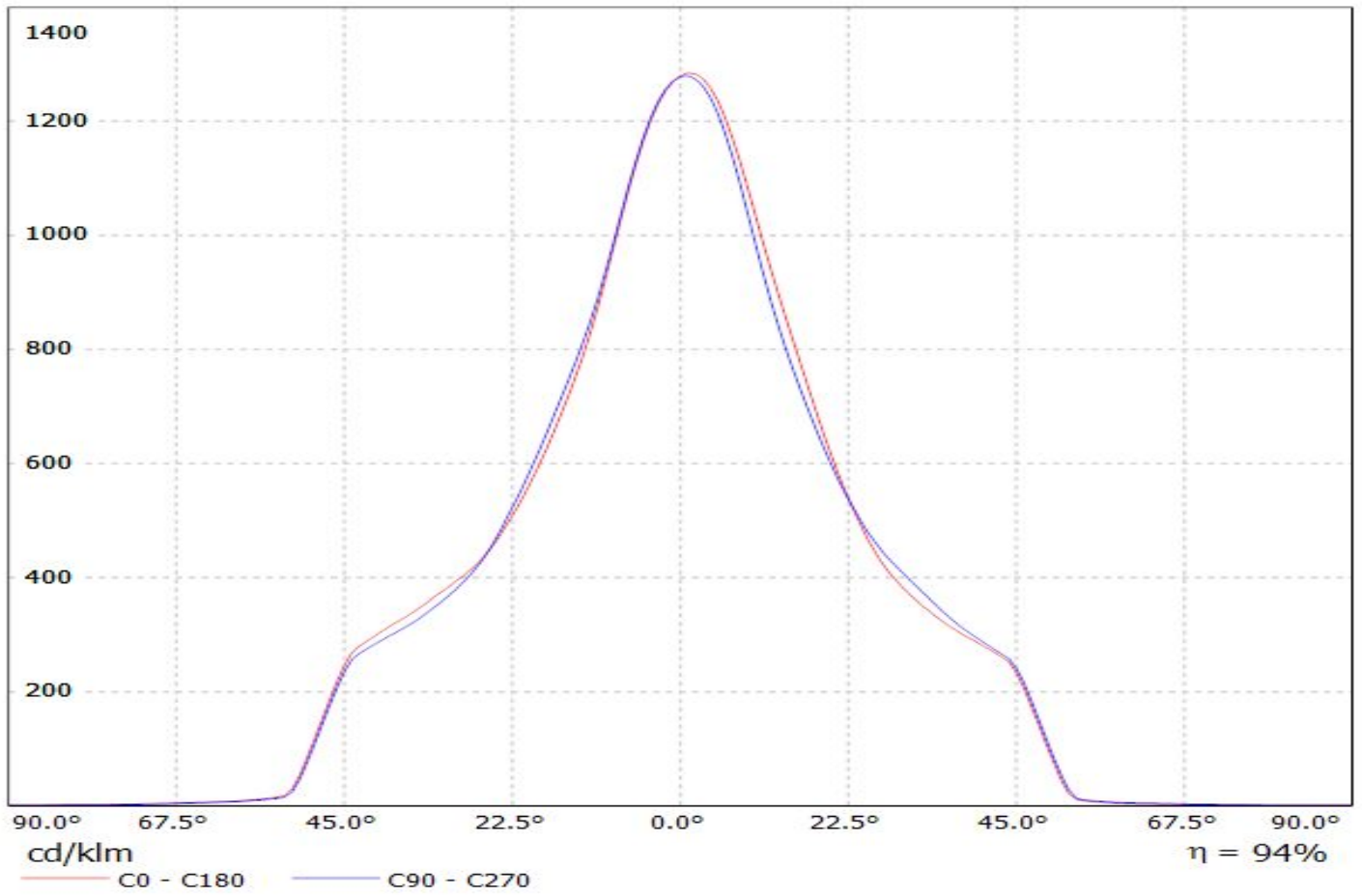

Luminaire: LEDiL Oy F13660\_ANGELINA-M-B\_(COB\_40W)

Lamps: 1 x LG\_COB\_40W\_1163.31lm@250mA\_CCT=3000K\_P=8.04906W\_I=249.8mA

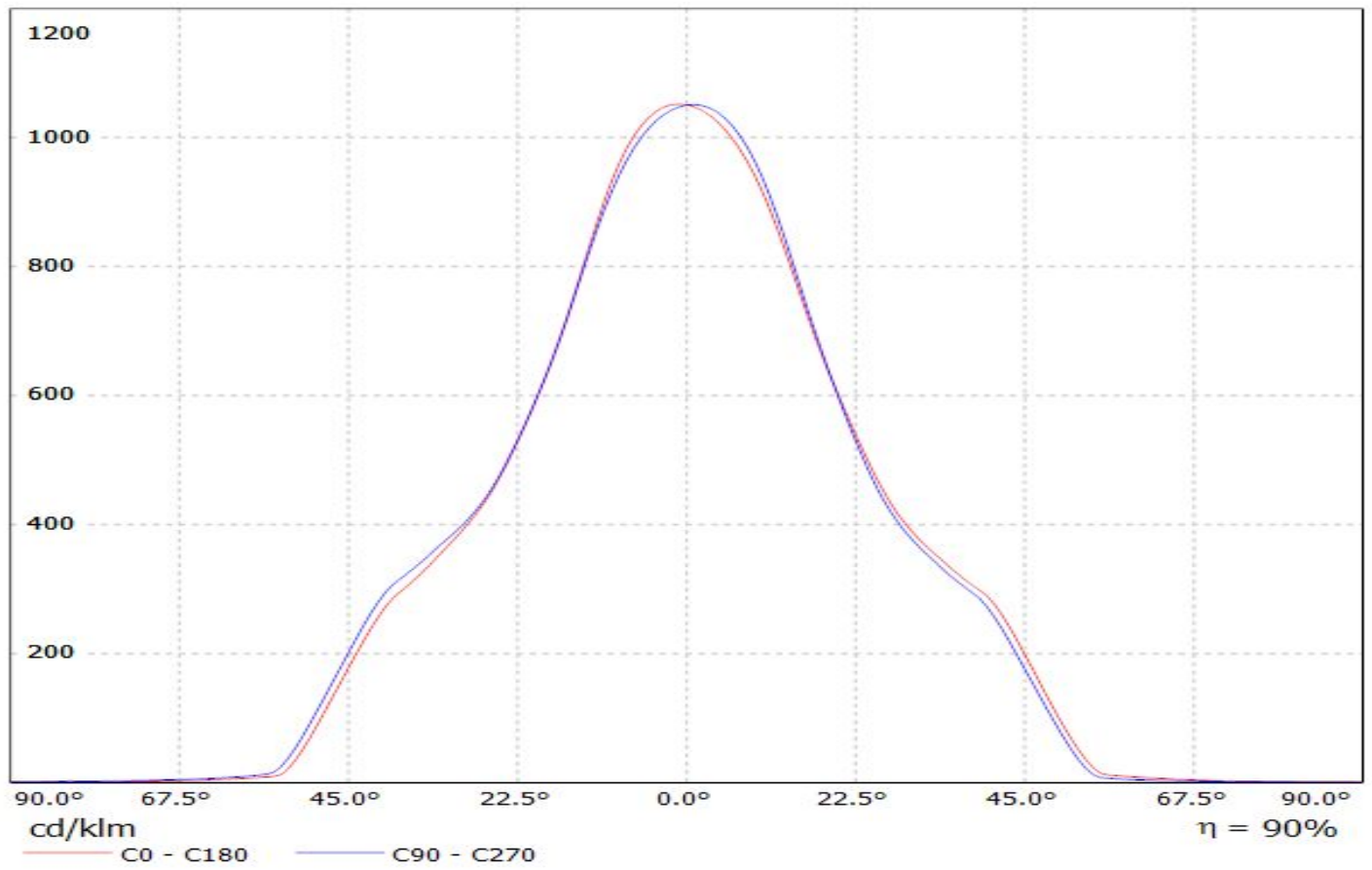

**Ledil F13660\_ANGELINA-M-B\_(Luxeon\_K16)\_(47\_319\_2070) / LDC (Linear)**

Luminaire: Ledil F13660\_ANGELINA-M-B\_(Luxeon\_K16)\_(47\_319\_2070)

Lamps: 1 x Philips\_Lumileds\_Luxeon\_K16\_(BJB.47.319.2070)  
\_1276.25lm@250mA\_P=10.95525W\_I=0.250A

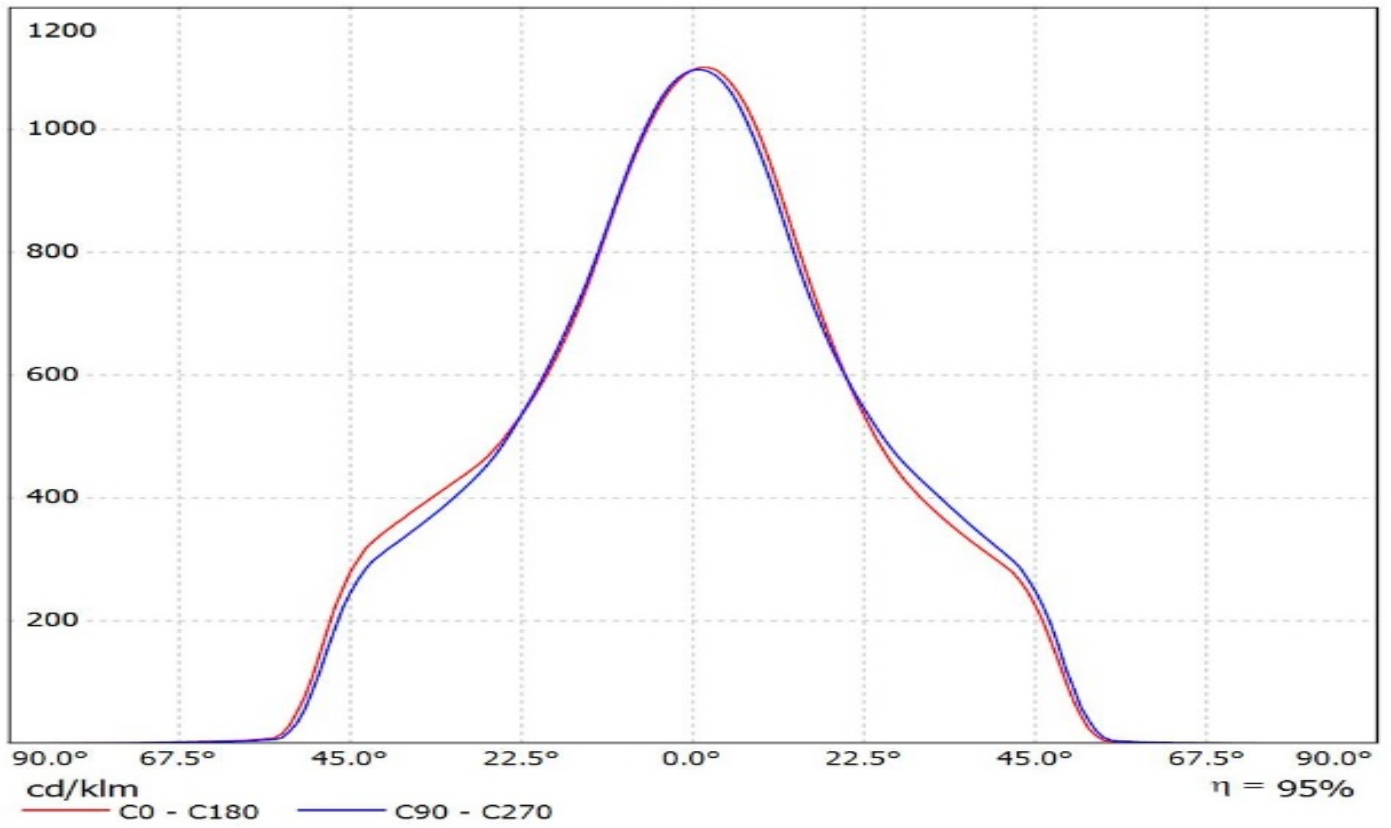

Luminaire: LEDiL Oy F13660\_ANGELINA-M-B\_(Luxeon\_CoB\_1205)

Lamps: 1 x LUXEON\_COB\_1205\_(LHC1-3080-1205)\_1274.35lm@250mA\_CCT=3000K\_P=11.183W\_I=249.8mA

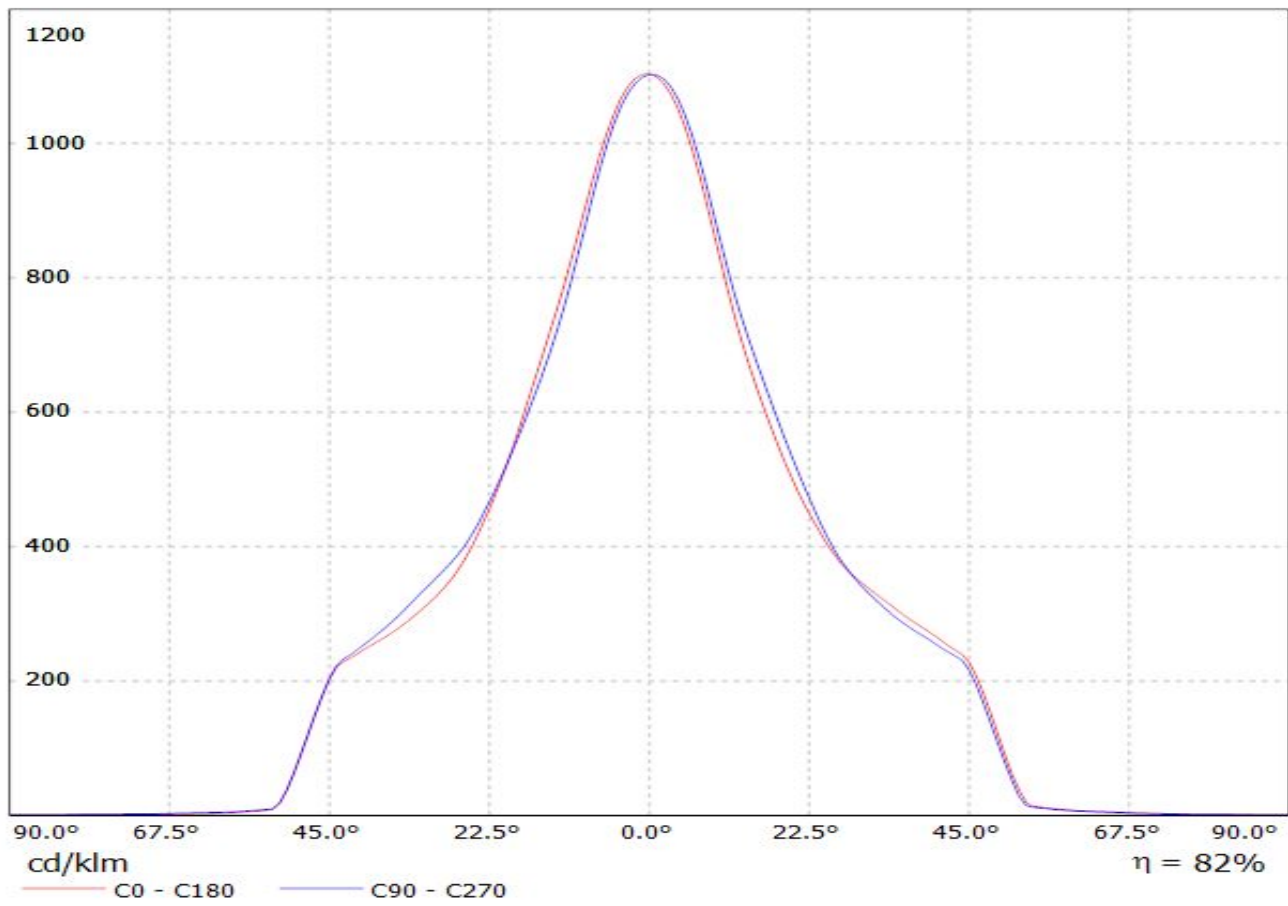

Luminaire: LEDiL Oy F13660\_ANGELINA-M-B\_(Luxeon\_CoB\_1208)  
Lamps: 1 x Luxeon\_CoB\_1208\_1057.71lm@250mA\_P=8.26438W\_I=249.8mA

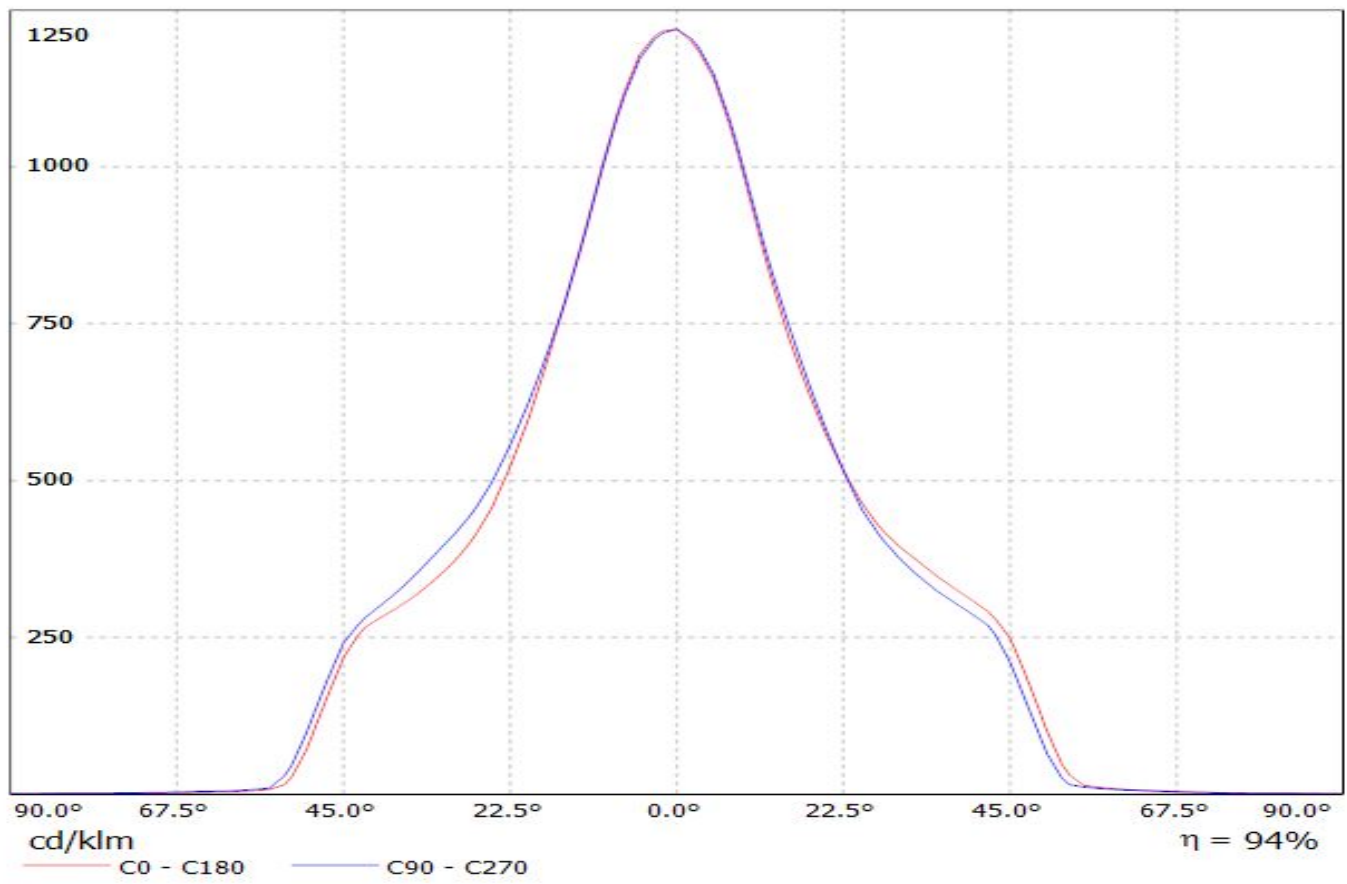

Luminaire: LEDiL Oy F13660\_ANGELINA-M-B\_(Luxeon\_CoB\_1211)  
Lamps: 1 x LUXEON\_COB\_1211\_(LHC1-2790-1211)  
\_923.583lm@250mA\_CCT=2700K\_P=8.00909W\_I=249.8mA

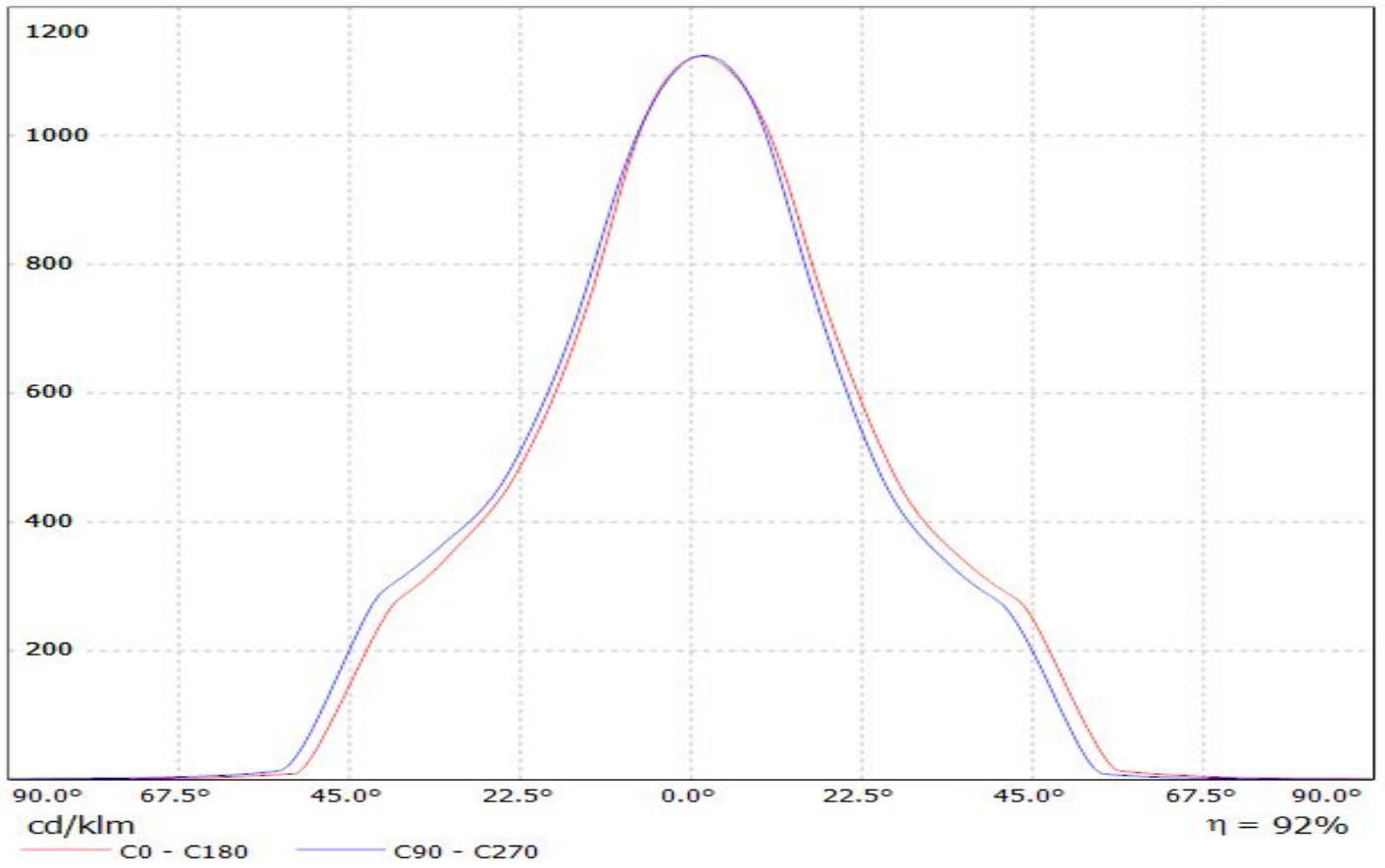

Luminaire: LEDiL Oy F13660\_ANGELINA-M-B\_(Luxeon\_CoB\_1211)\_(BJB2030) 82  
Lamps: 1 x Luxeon\_CoB\_1211\_(LHC1-5780-1211)\_(BJB2030)\_1330.16lm@250mA\_P=8.03503W\_I=0.2499A

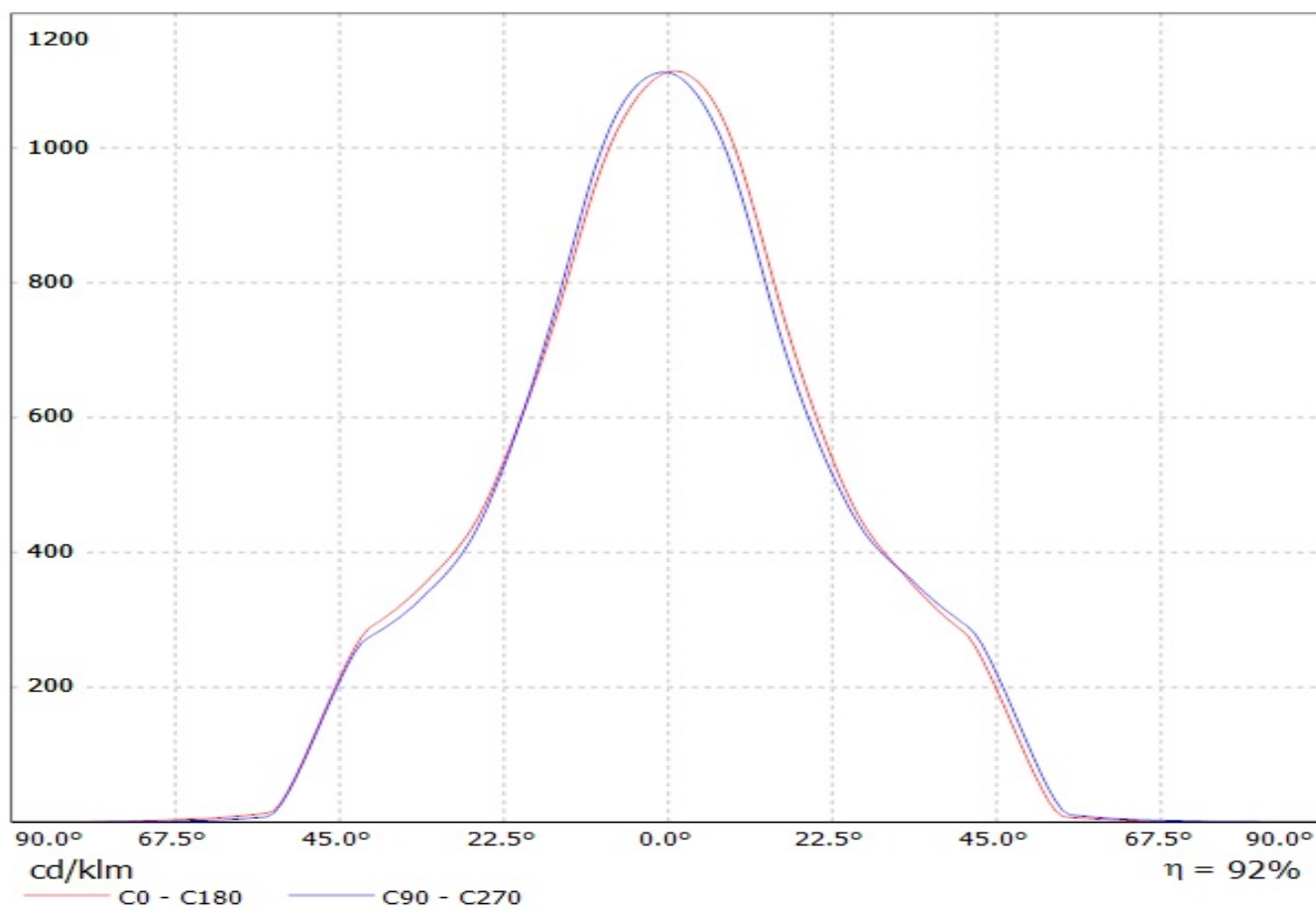

Luminaire: Ledil F13660\_ANGELINA-M-B\_(CoB\_1216)

Lamps: 1 x Luxeon\_CoB\_1216\_(L2C2-40801216E2300)\_1478.53lm@250mA\_P=8.0068W\_I=0.25A

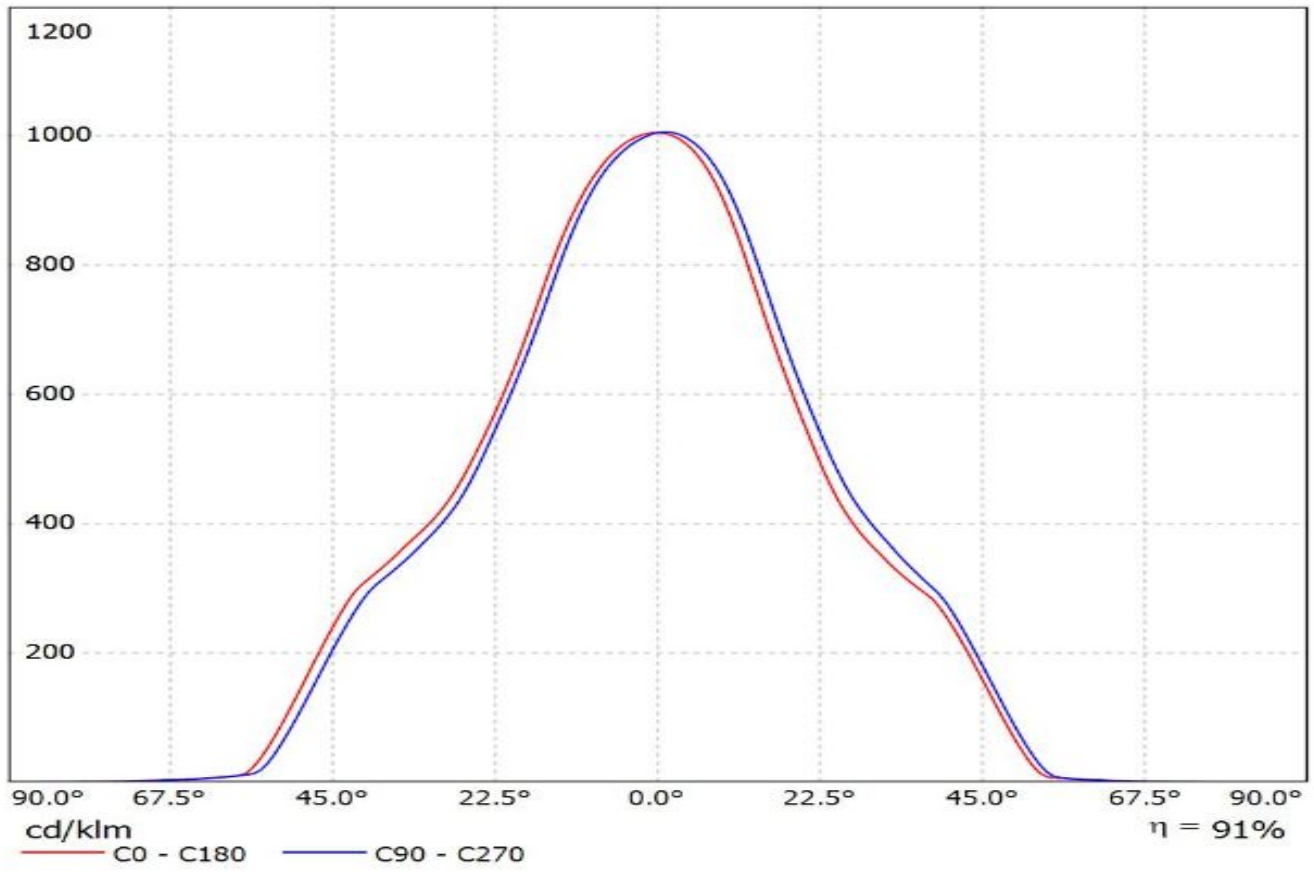



Luminaire: LEDiL Oy F13660\_ANGELINA-M-B\_(CXM-22) Eff.91.8%  
Lamps: 1 x LUMINUS\_CXM-22\_1221.8lm@250mA\_P=8.00809W\_CCT=3000K\_I=249.8mA

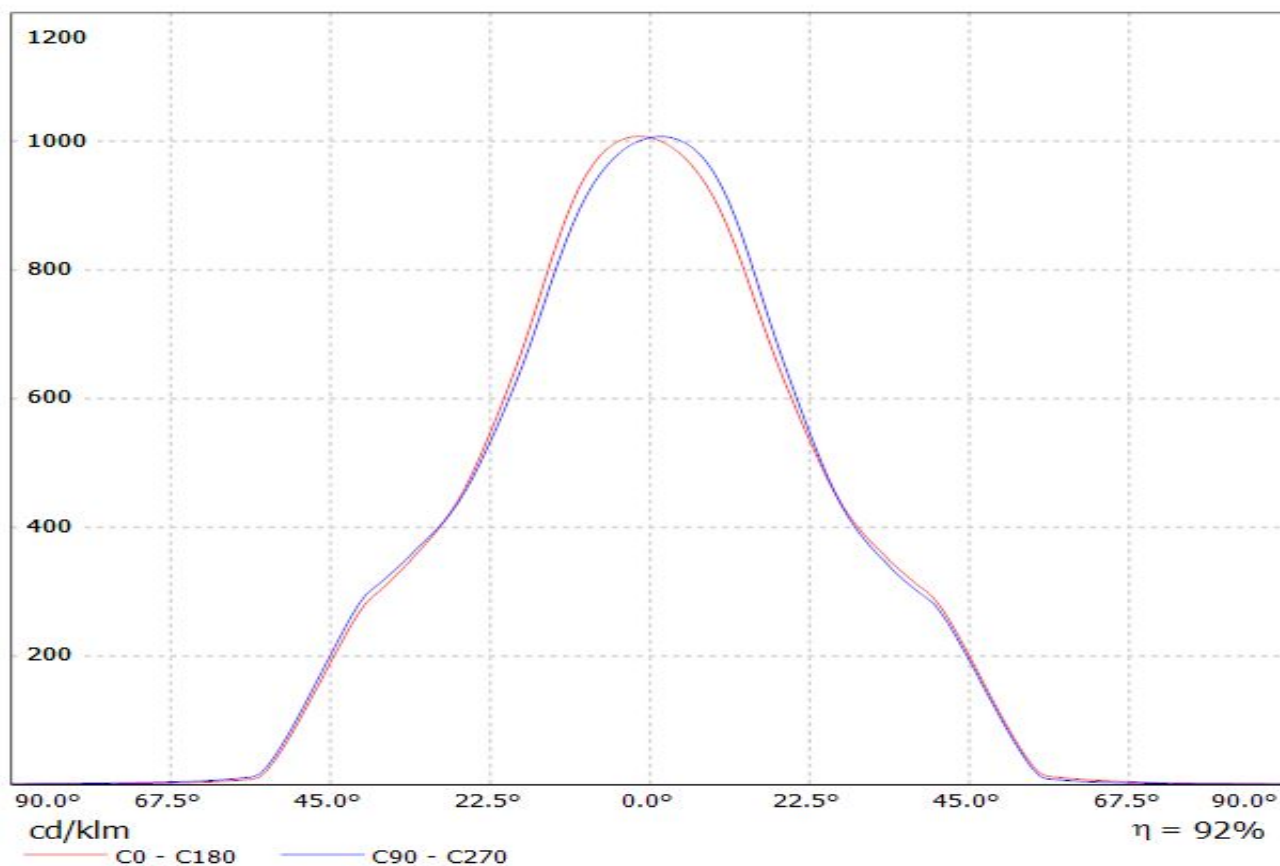

Luminaire: LEDil Oy F13660\_ANGELINA-M-B\_(CXM-14)

Lamps: 1 x Luminus CXM-14 (1078.95lm @ 250mA) CCT=3100K P=8.5W I=250mA

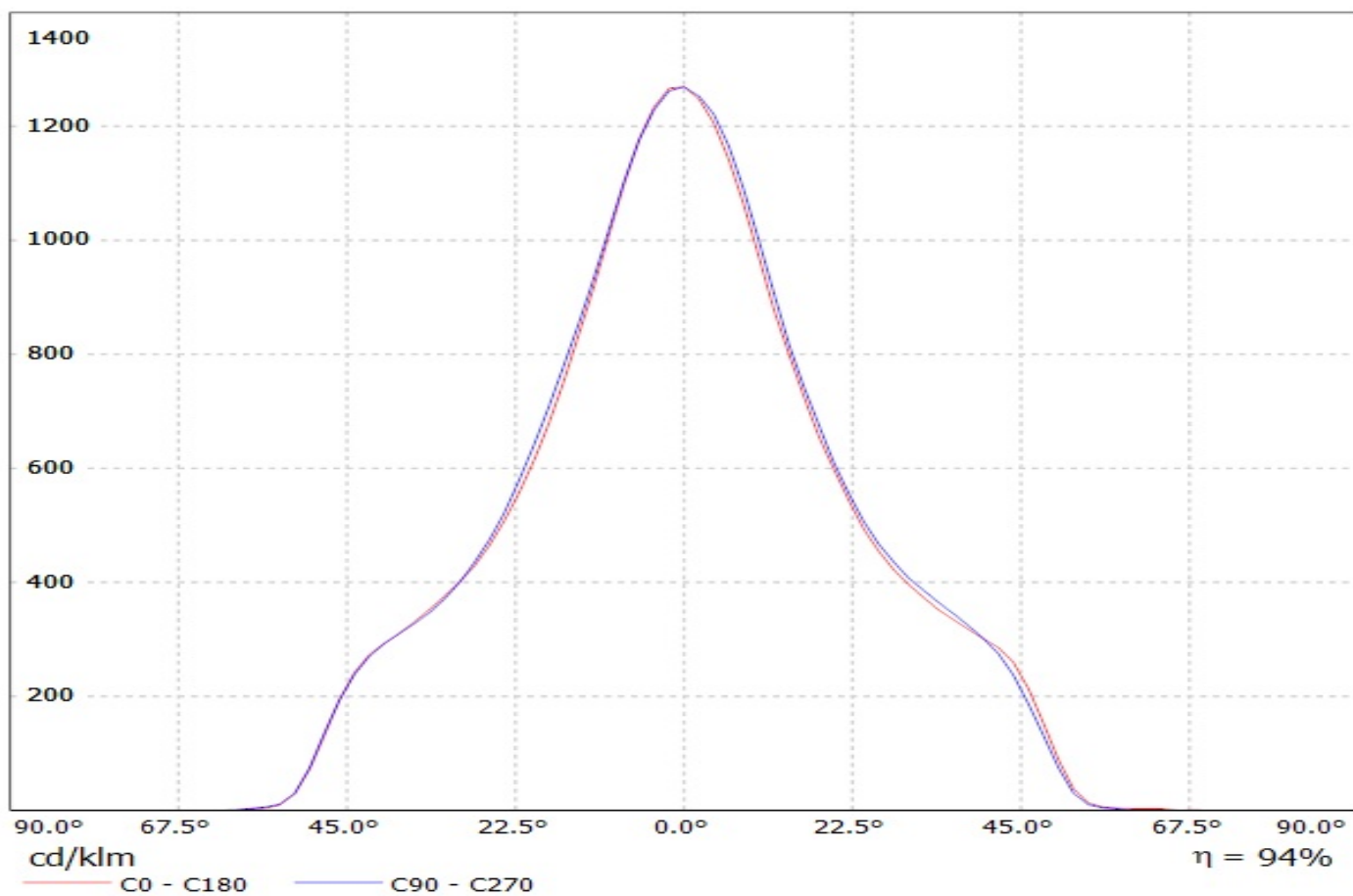

Luminaire: LEDiL Oy C13660\_ANGELINA-M-B\_(Soleriq-E30) Eff. 90 %  
Lamps: 1 x Osram Soleriq E30 (QW KAJRB2.EM-TPTR-50H4) 1358.6lm@250mA\_P=10.2338W\_I=0.2498mA

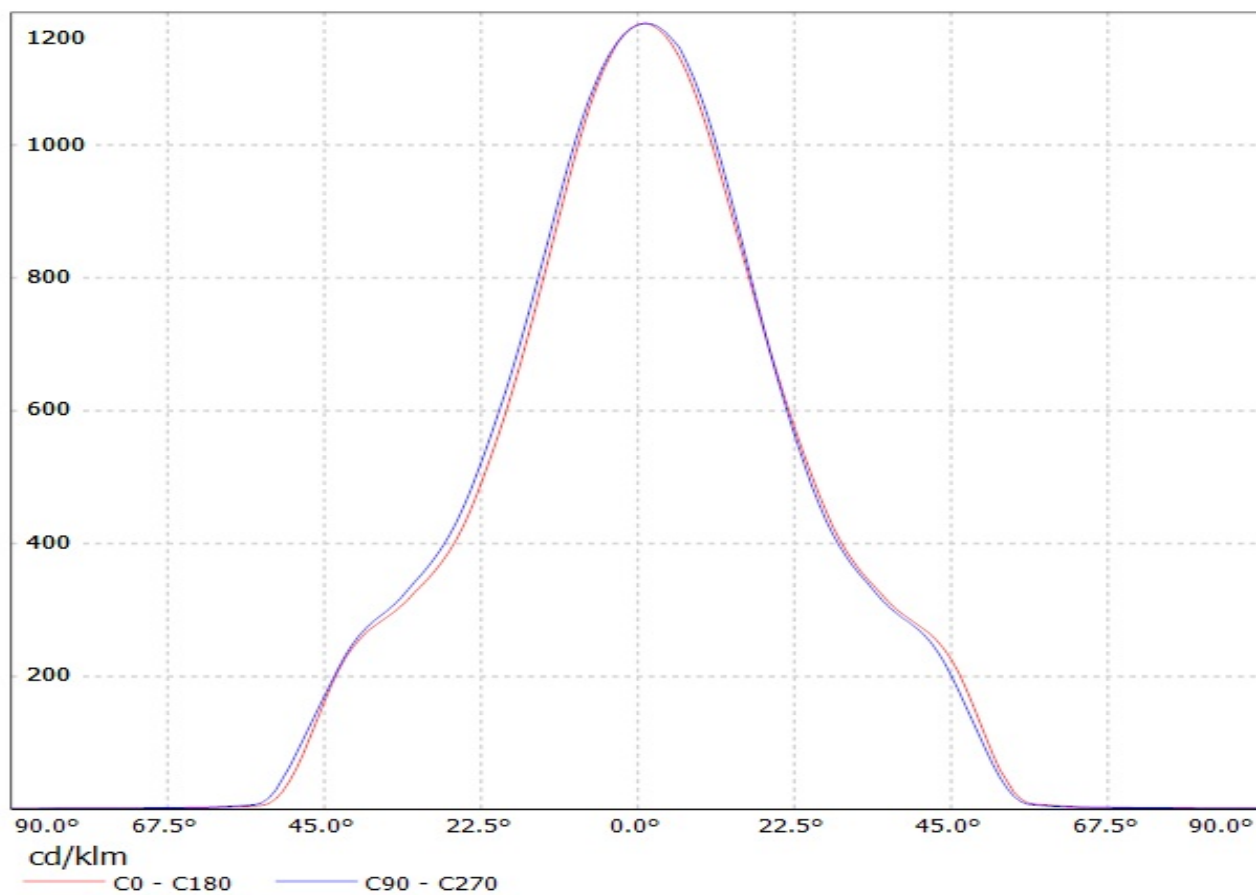

Luminaire: LEDiL Oy F13660\_ANGELINA-M-B\_(Soleriq\_S13) Eff.94.0%  
Lamps: 1 x Osram\_Soleriq\_S13\_825.418lm@250mA\_CCT=3125K\_P=7.33663W\_I=249.8mA

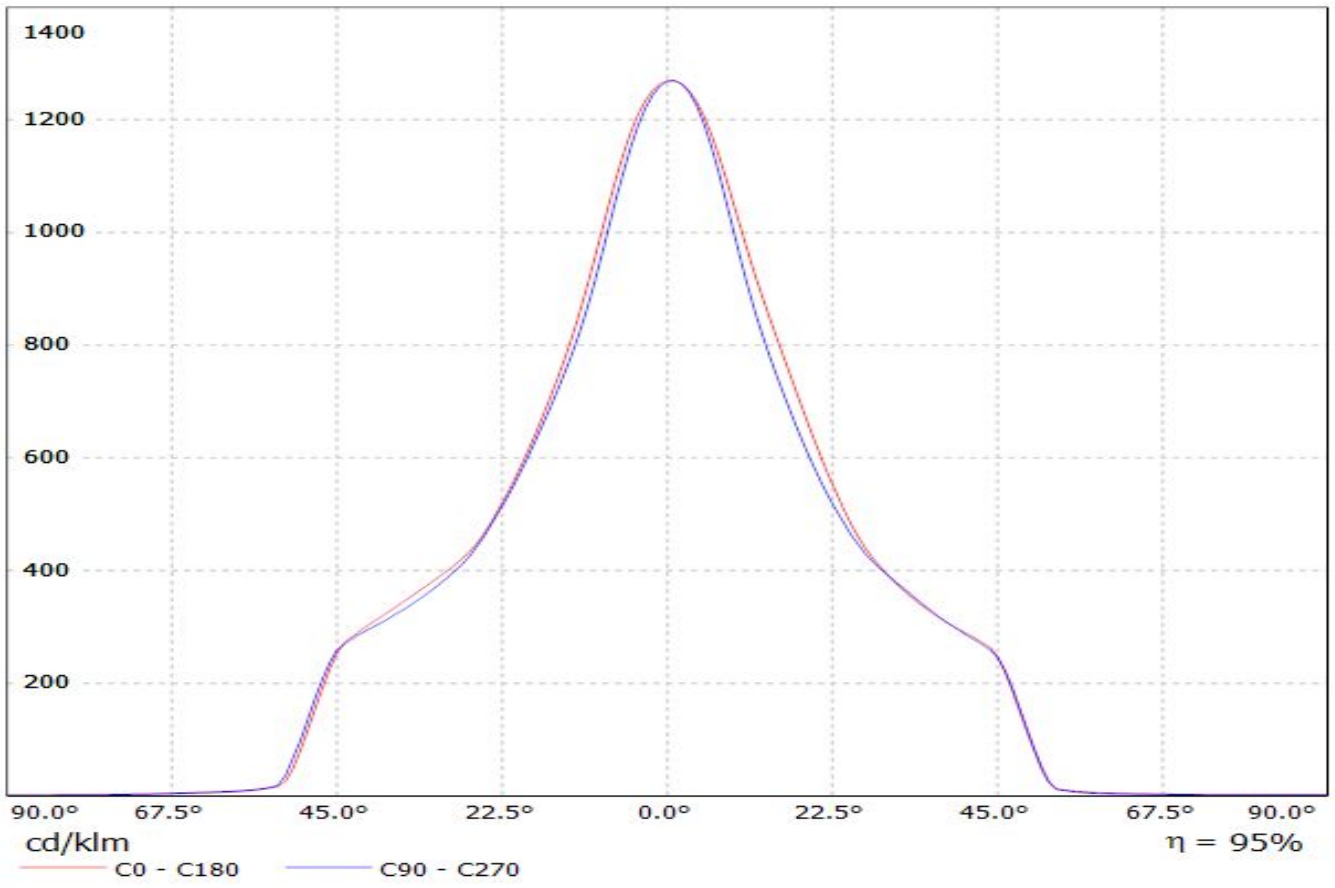

Luminaire: LEDiL Oy F13660\_ANGELINA-M-B\_(Soleriq S19) Eff.93.8%  
Lamps: 1 x OSRAM\_SOLERIQ\_S19\_(GW\_KAHJB1.EM)  
\_1445.44lm@250mA\_CCT=3000K\_P=10.558W\_I=249.8mA

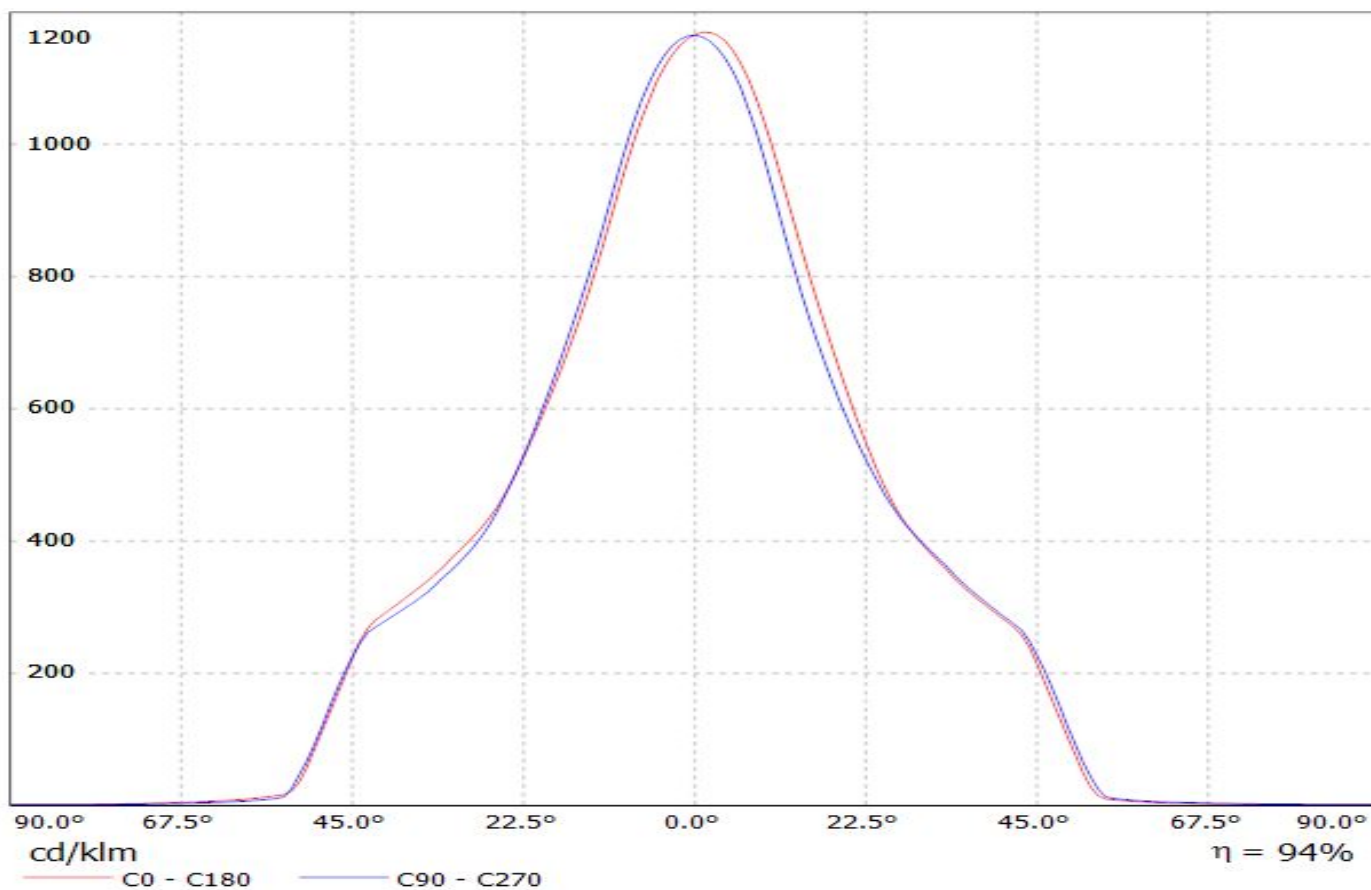

Luminaire: LEDiL Oy F13660\_ANGELINA-M-B\_(S19) Eff.93.3%  
Lamps: 1 x Osram\_SOLERIQ\_S19\_1434.85lm@250mA\_P=10.5595W\_I=249.8mA

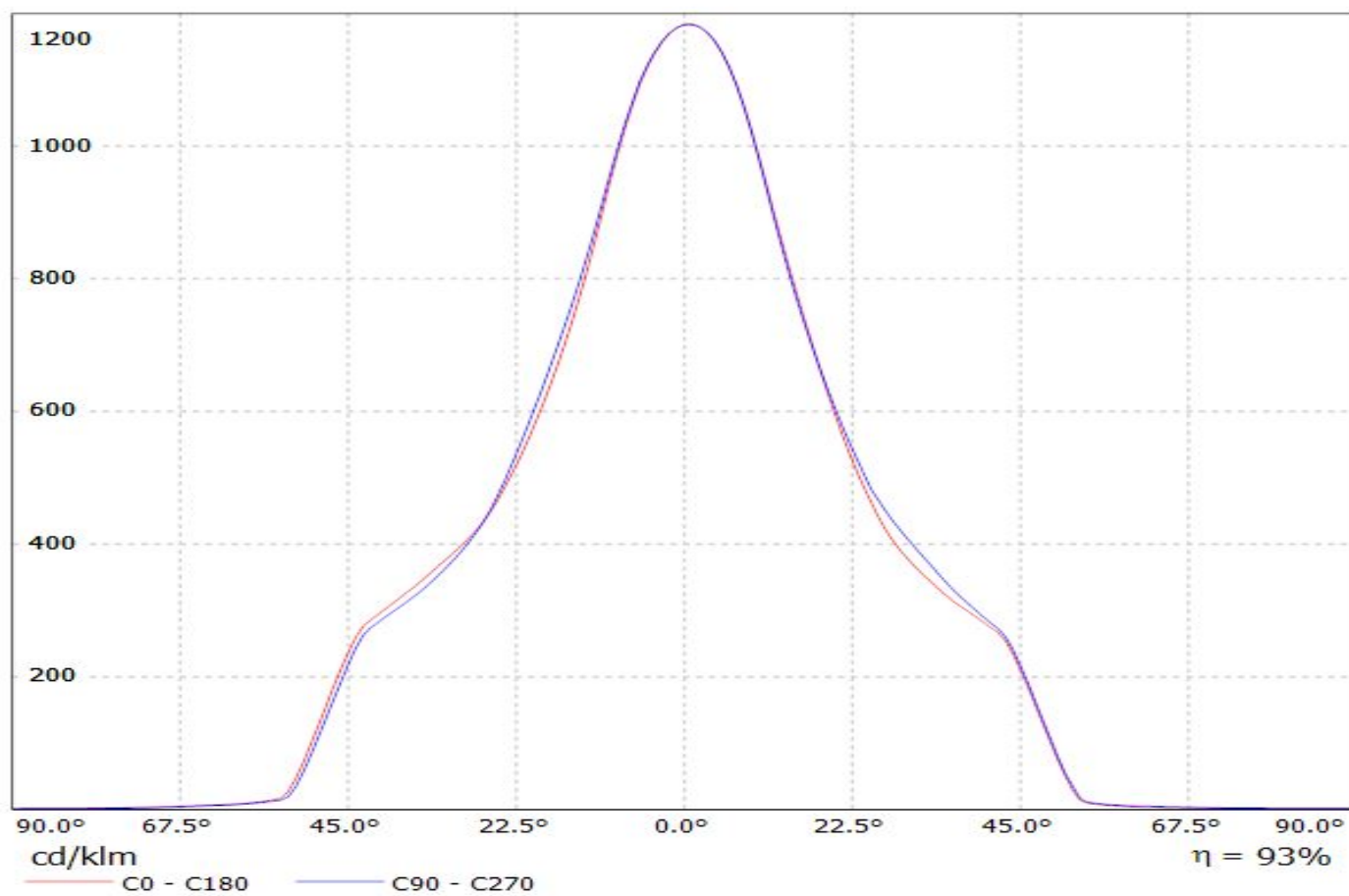

Luminaire: LEDiL Oy F13660\_ANGELINA-M-B\_(SOLERIQ\_P13)

Lamps: 1 x SOLERIQ\_P13\_(GW\_MAGMB1.EM)\_1053.65lm@250mA\_CCT=3000K\_P=8.82044W\_I=249.8mA

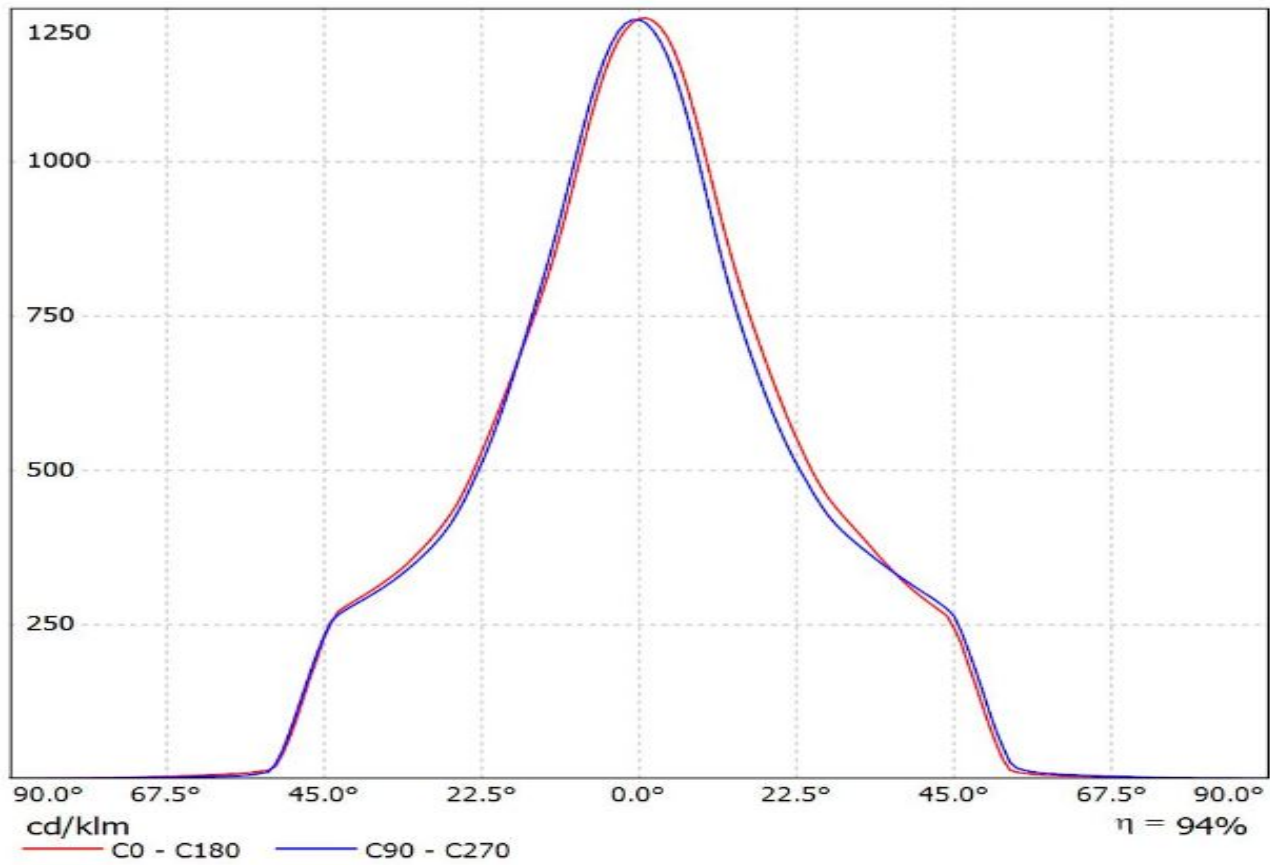

# Ledil F13660\_ANGELINA-M-B\_(Soleriq\_S13\_G2) / LDC (Linear)

Luminaire: Ledil F13660\_ANGELINA-M-B\_(Soleriq\_S13\_G2)

Lamps: 1 x Osram\_Soleriq\_S13\_G2\_(GW\_KAGHB2.EM)1353.18lm@250m\_P=8.46W\_I=0.25A

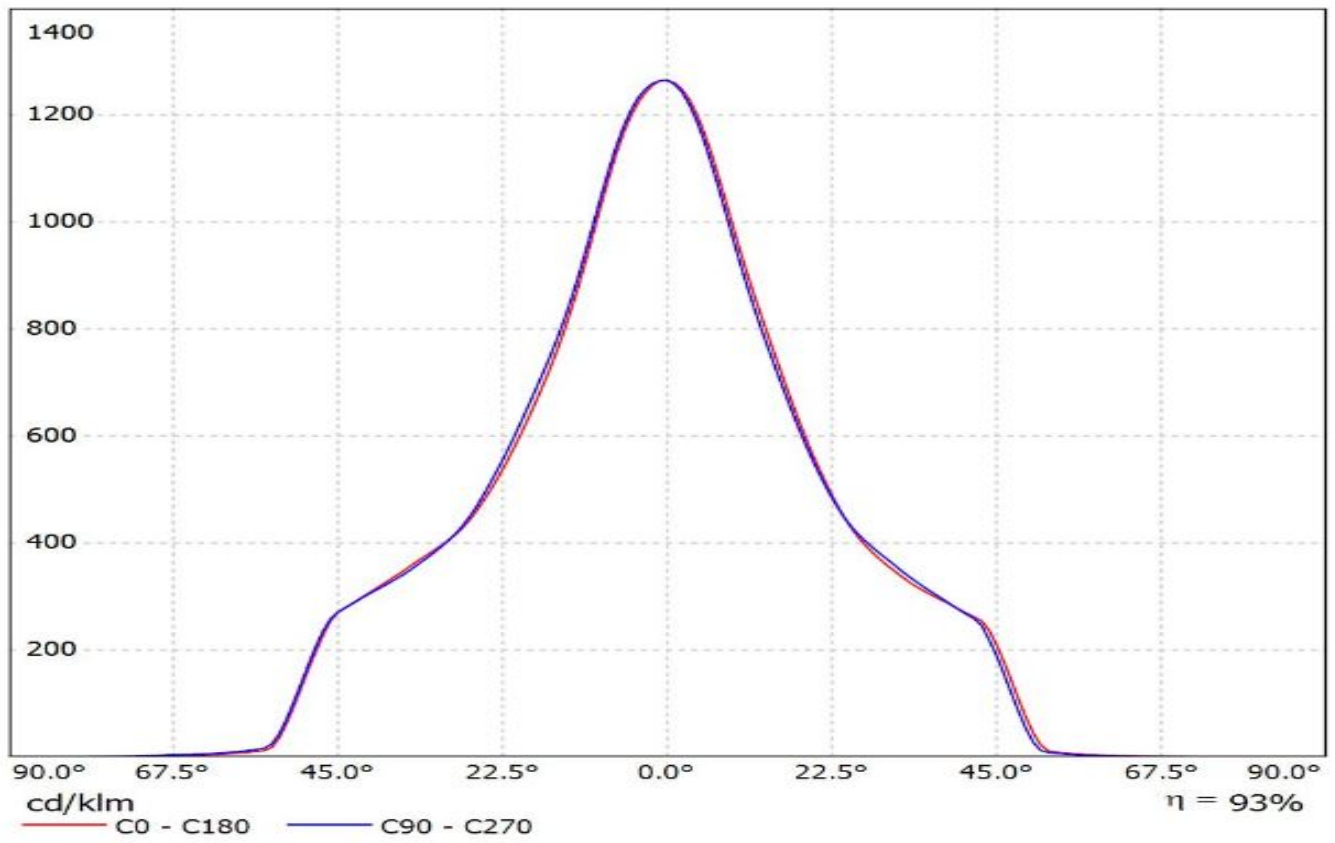



Luminaire: Ledil Oy F13660\_ANGELINA-M-B+\_BJB\_47.319.2030\_SAMSUNG\_COB\_D\_LC040D\_SIMULATED  
Lamps: 1 x SAMSUNG LC040D

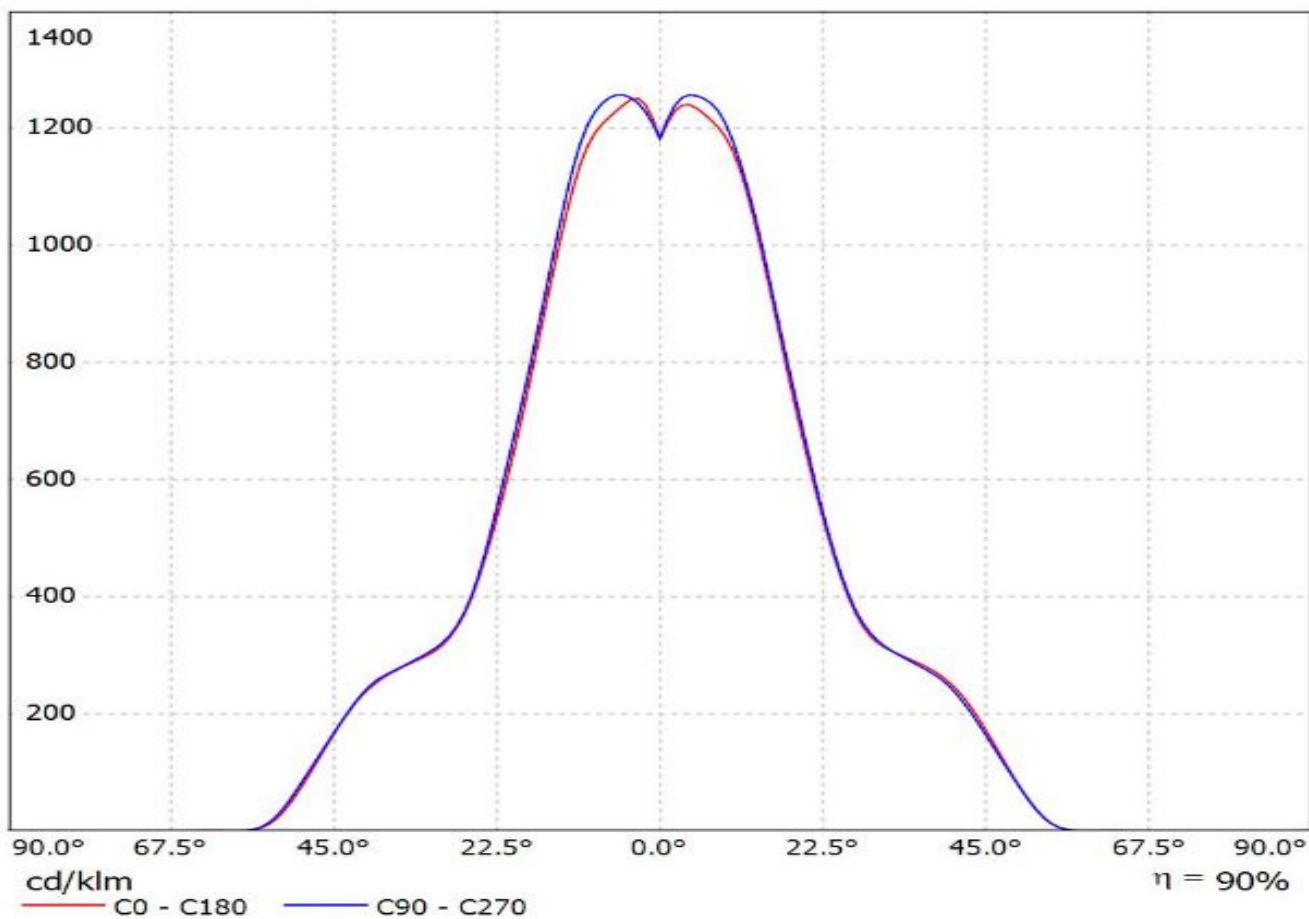

Luminaire: LEDiL Oy F13660\_ANGELINA-M-B\_(COB\_D\_14,5mm)

Lamps: 1 x Samsung\_COB\_D\_Series-LES-14,5\_LC026D\_1296.34lm@250mA\_CCT=3000K\_P=8.1225W\_I=0.250A

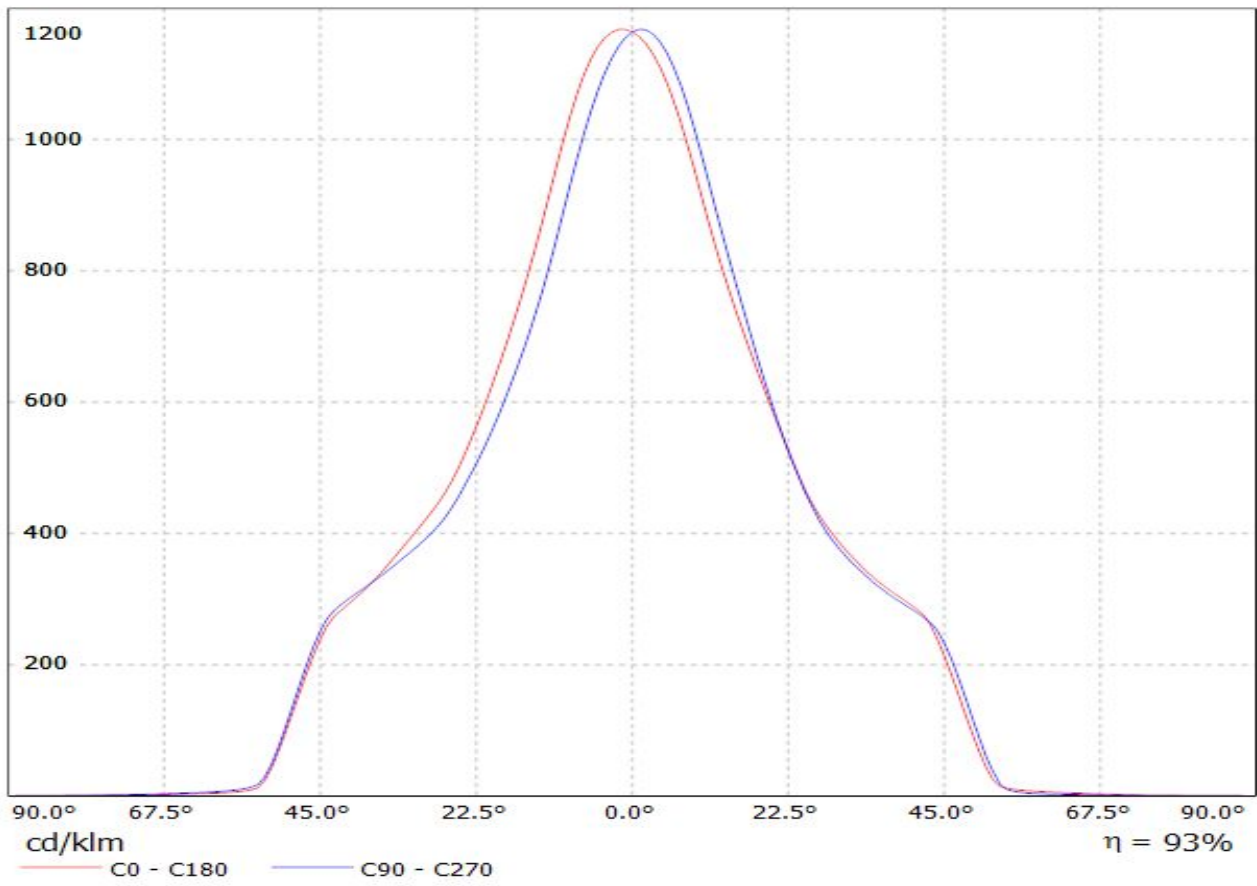

Luminaire: LEDiL Oy F13660\_ANGELINA-M-B\_(COB\_D\_14,5mm)

Lamps: 1 x Samsung\_COB\_D\_Series-LES-14,5\_LC026D\_1296.34lm@250mA\_CCT=3000K\_P=8.1225W\_I=0.250A

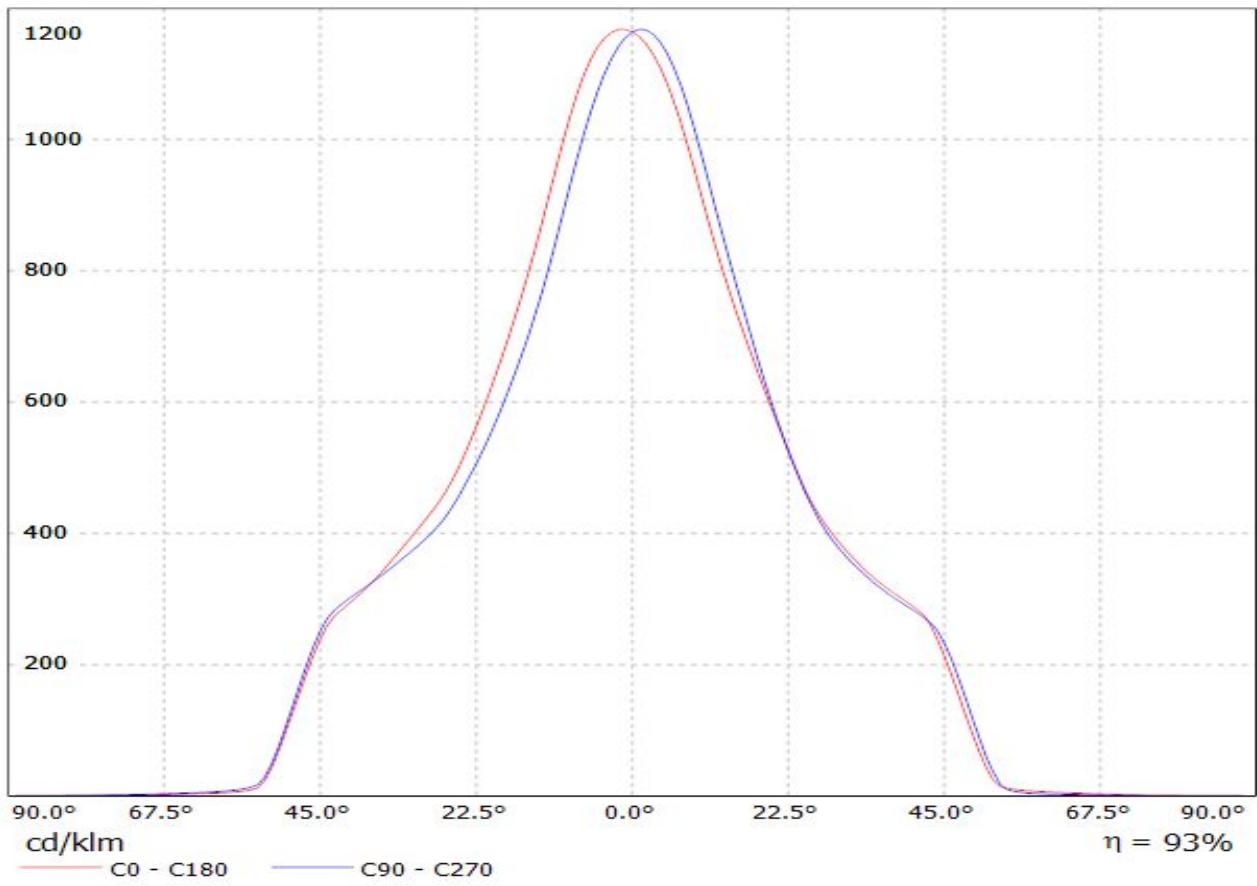

Luminaire: LEDiL Oy F13660\_ANGELINA-M-B\_(ZC12)

Lamps: 1 x SEOUL\_ZC12\_(SDW82F1C)\_1240.73lm@250mA\_P=8.68405W\_I=249.8mA

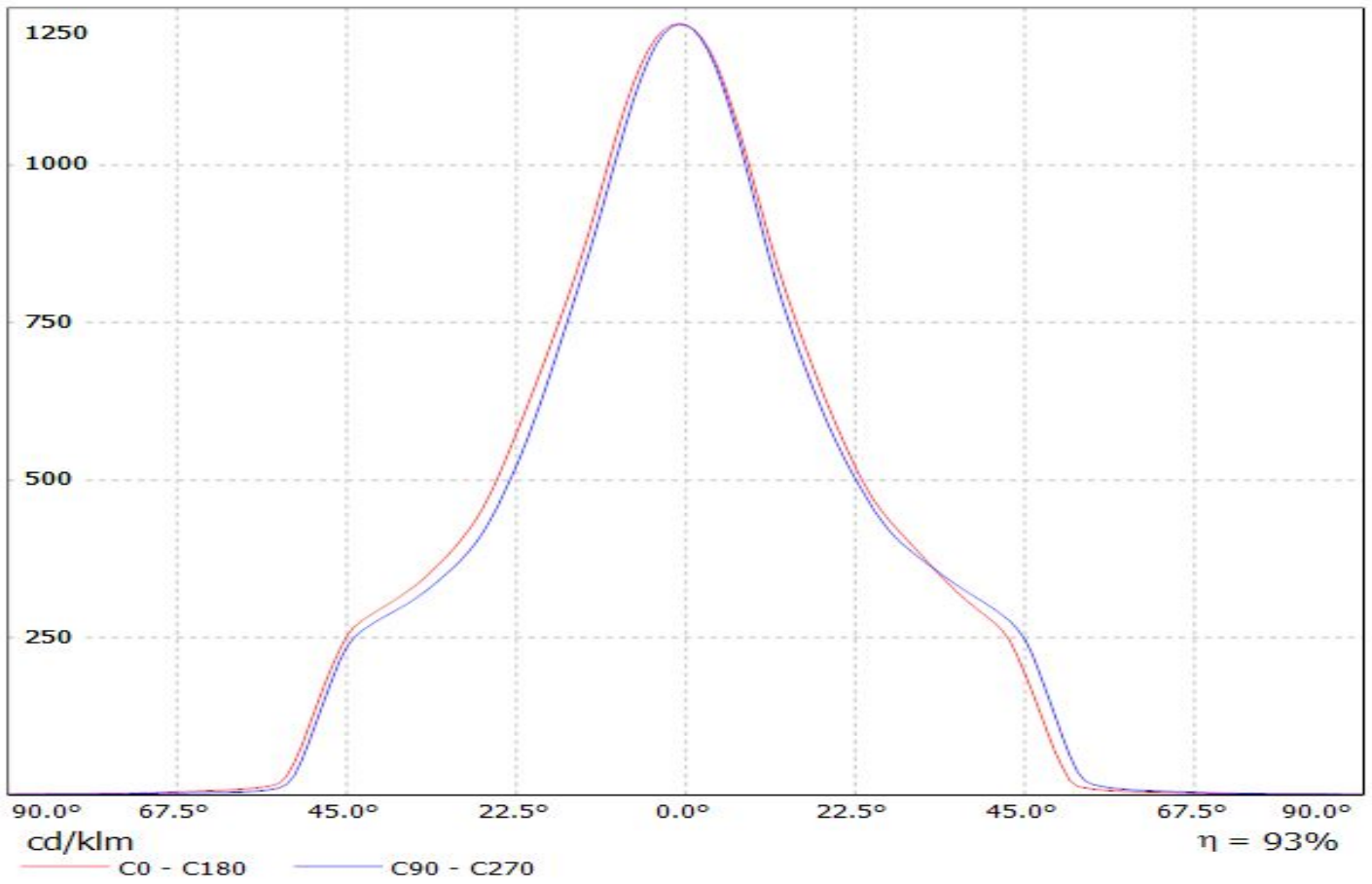

Luminaire: LEDiL Oy F13660\_ANGELINA-M-B\_(ZC40)

Lamps: 1 x SEOUL\_ZC40\_(SBWW5F1B)\_1185.55lm@250mA\_P=8.2384W\_I=249.8mA

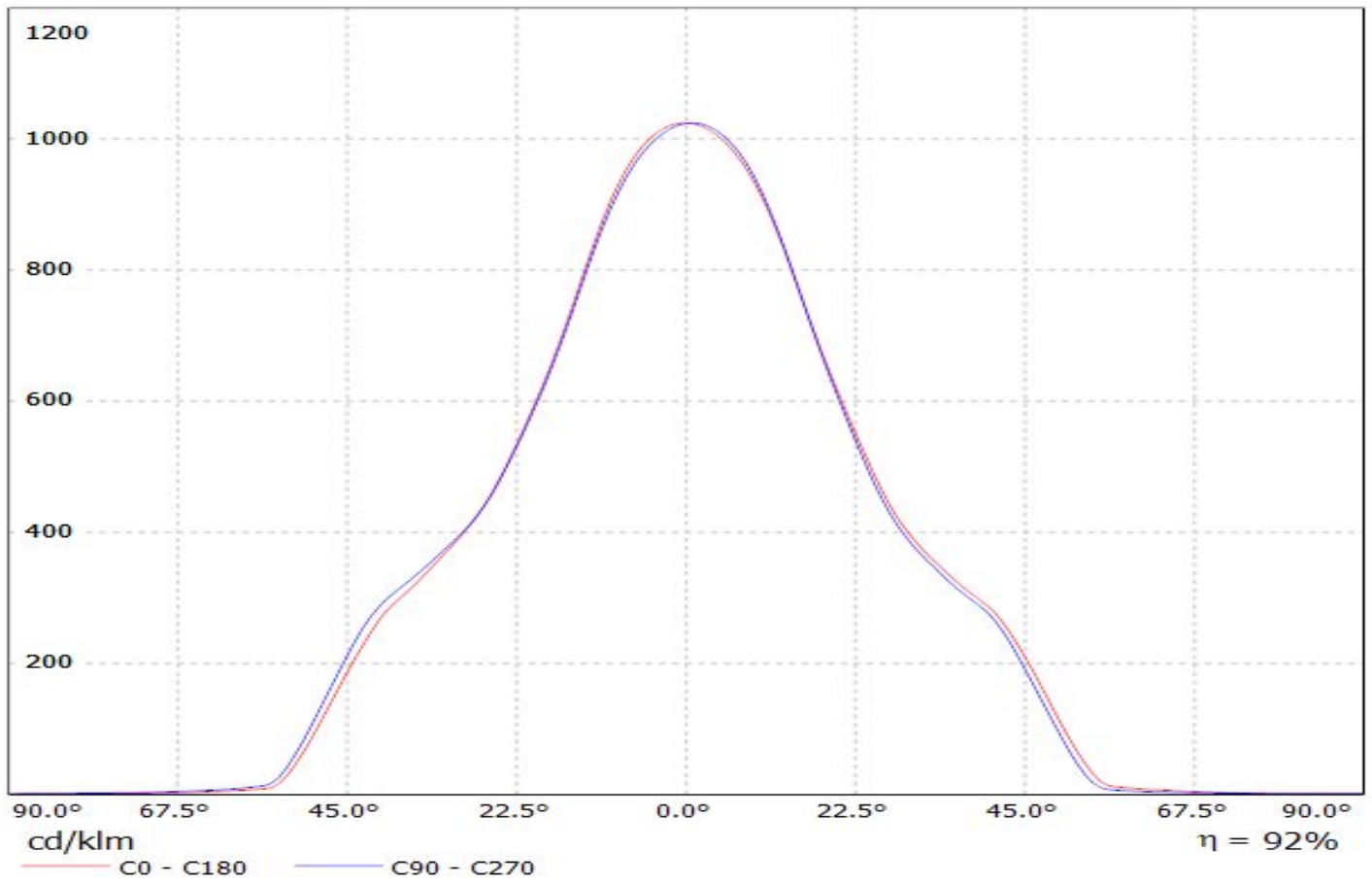

Luminaire: LEDiL Oy F13660\_ANGELINA-M-B\_(MegaZenigata\_GW6)  
Lamps: 1 x Sharp\_MegaZenigata\_GW6\_(GW6DME30NFC)  
\_1266.19lm@250mA\_CCT=3038K\_P=11.2151W\_I=250.6mA

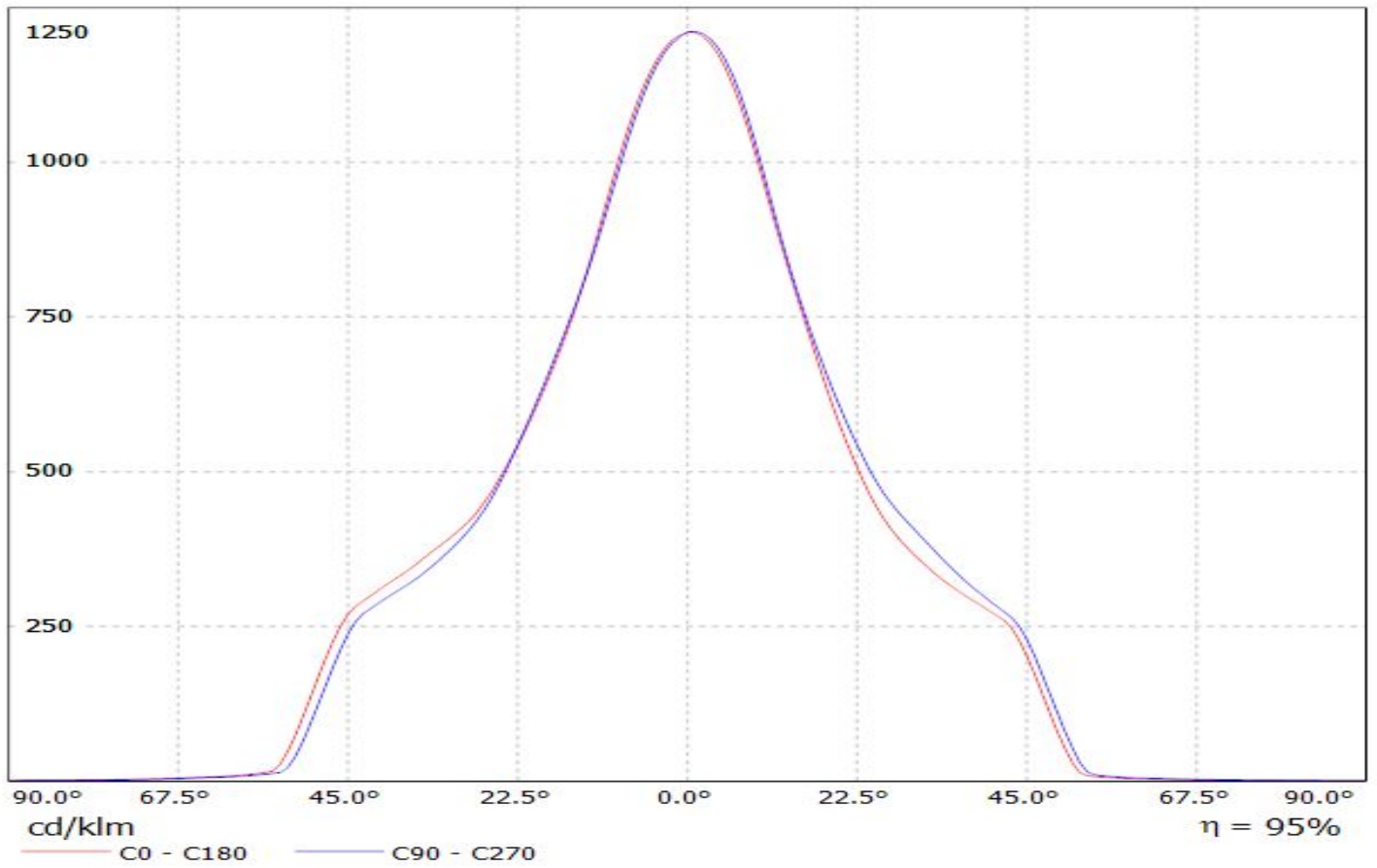

Luminaire: LEDiL Oy F13660\_ANGELINA-M-B\_(STARK\_SLE\_G3\_LES17)  
Lamps: 1 x TRIDONIC\_STARK\_SLE\_G3\_LES17\_(STARK-SLE-PURE\_G3-17-2000-840-CLA)  
\_1030.26lm@250mA\_CCT=2000K\_P=8.34707W\_I=249.8mA

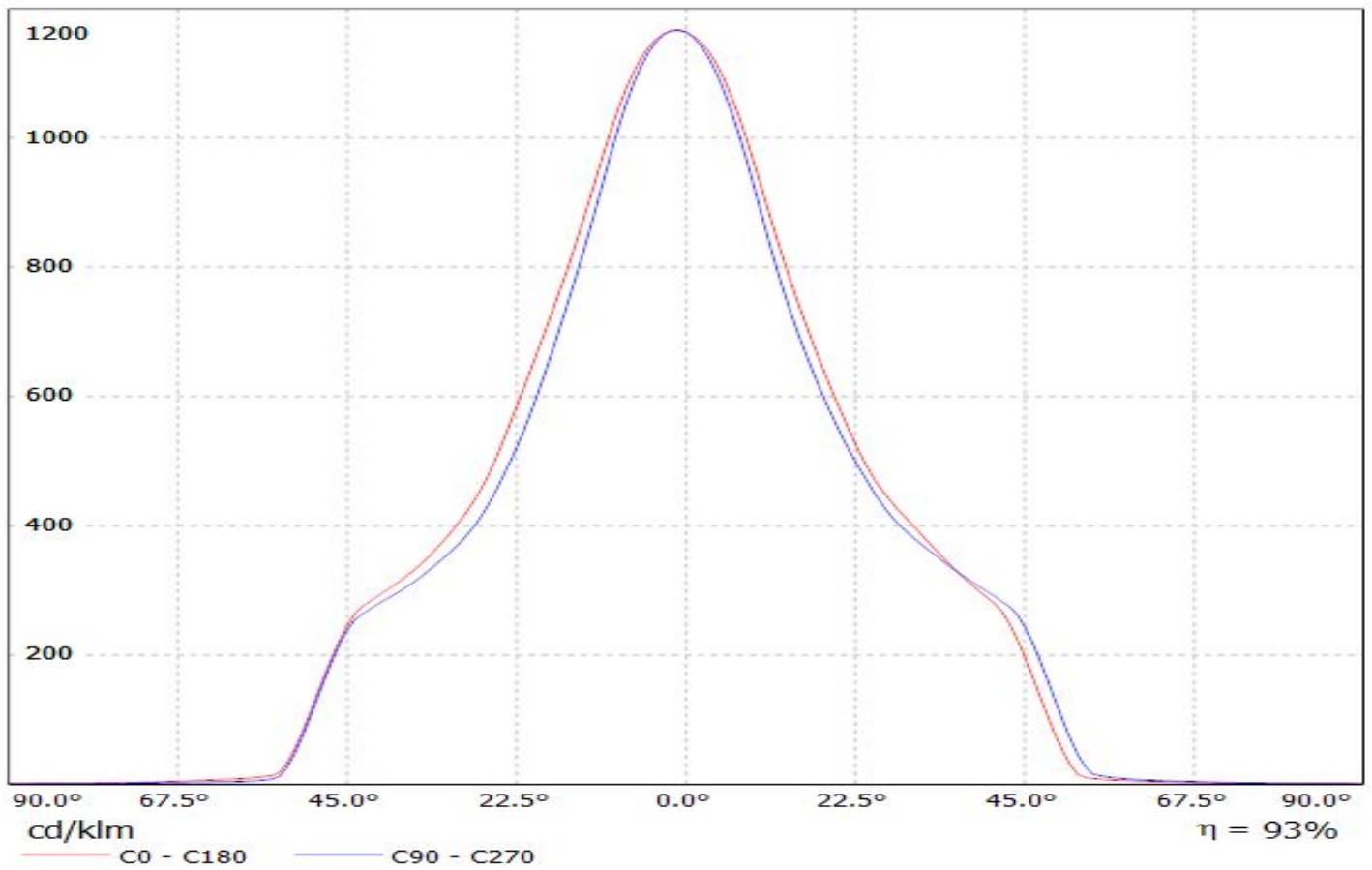

Luminaire: LEDiL Oy F13660\_ANGELINA-M-B\_(SLE G4 LES23)  
Lamps: 1 x Tridonic\_SLE\_G4\_LES23\_1428.75lm@250mA\_P=8.19944W\_I=0.2498A

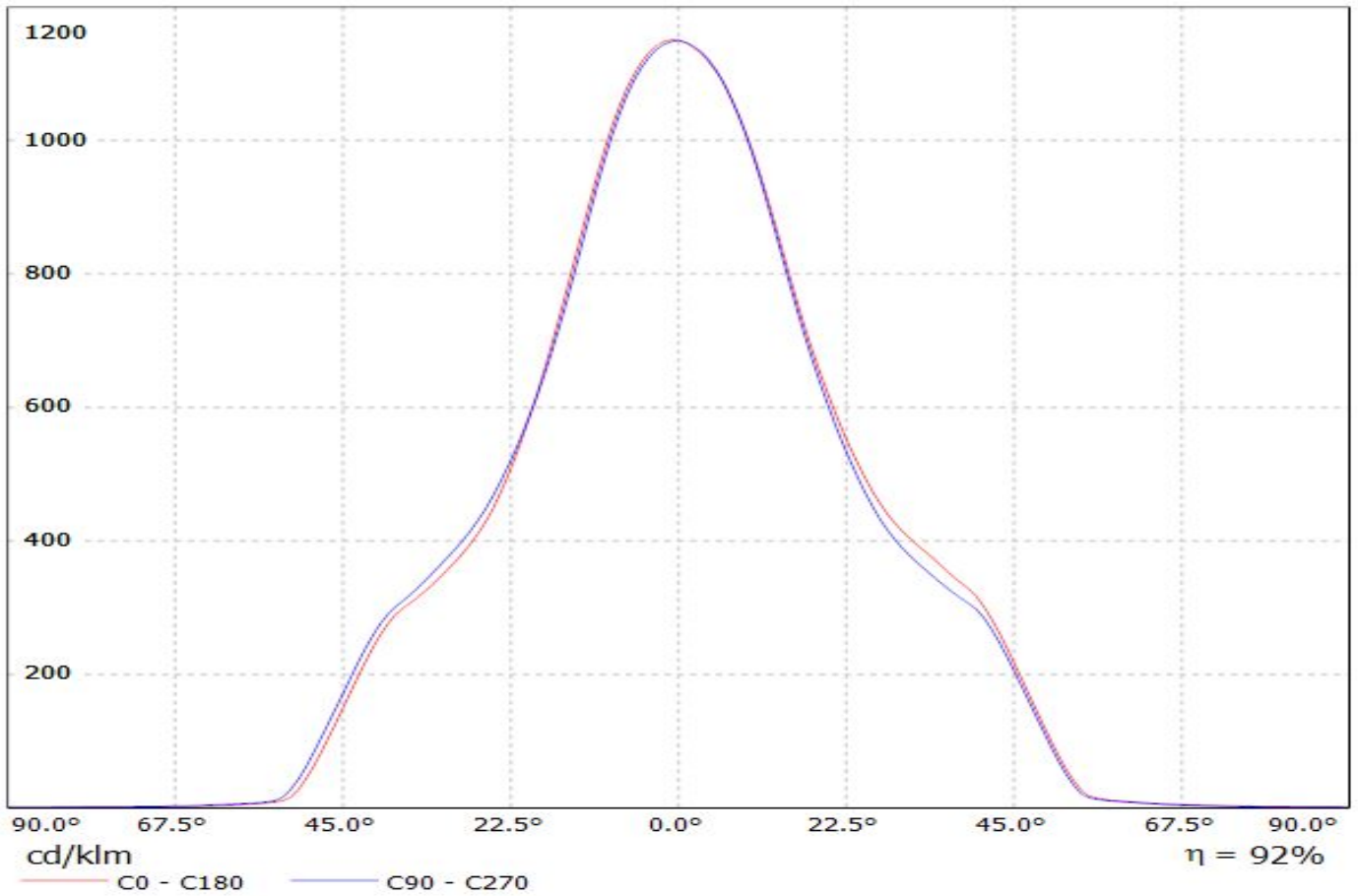



Luminaire: LEDiL Oy F13660\_ANGELINA-M-B\_(SLE GEN4 LES19)  
Lamps: 1 x SLE GEN4 LES19\_1226.28lm@250mA\_P=8.21367W\_I=0.2498A

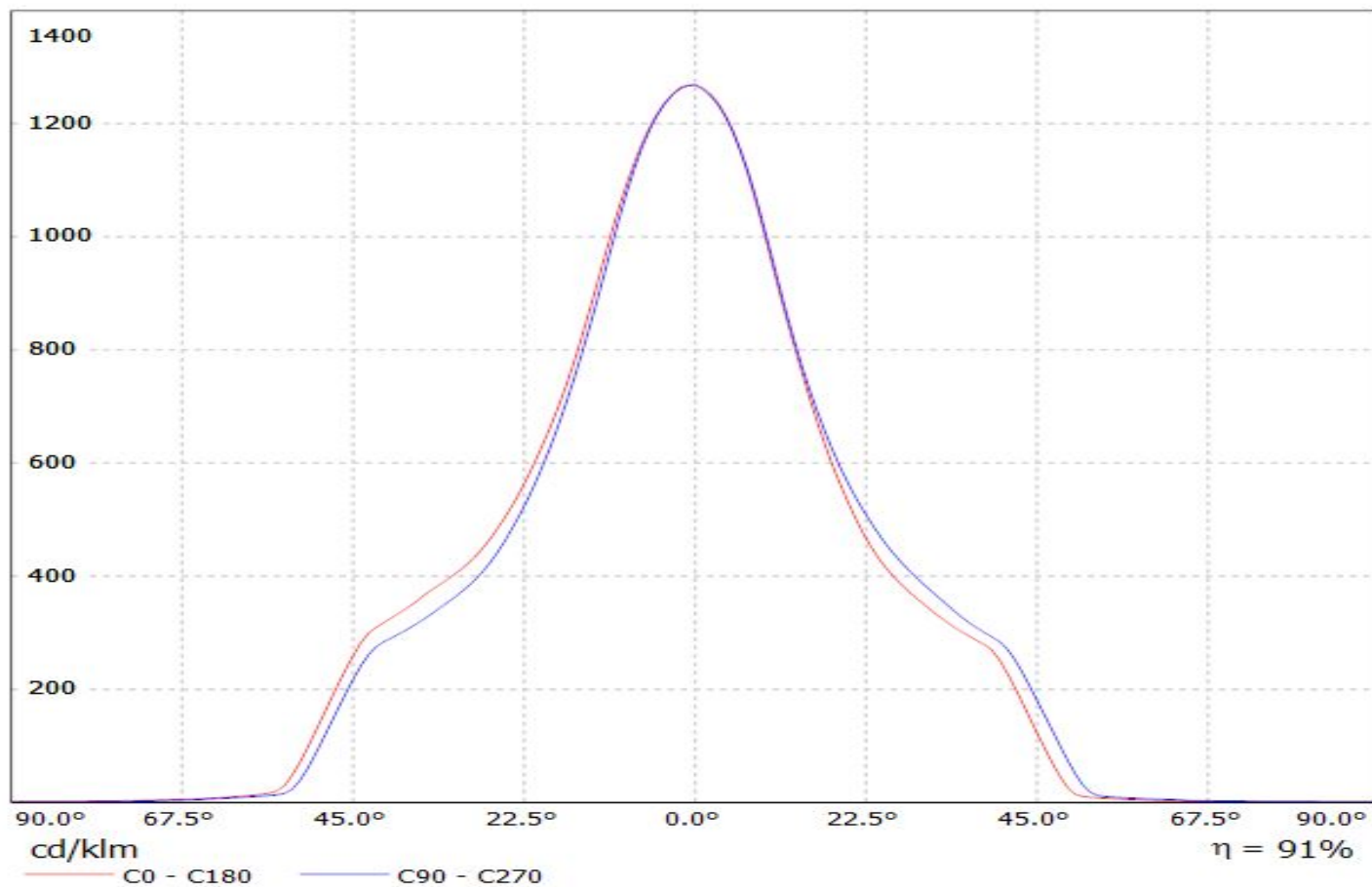

Luminaire: LEDiL Oy F13660\_ANGELINA-M-B\_(SLE-G5\_LES-15)  
Lamps: 1 x Tridonic\_SLE-G5\_LES-15\_1272.36lm@250mA\_P=8.6660W\_I=0.250A

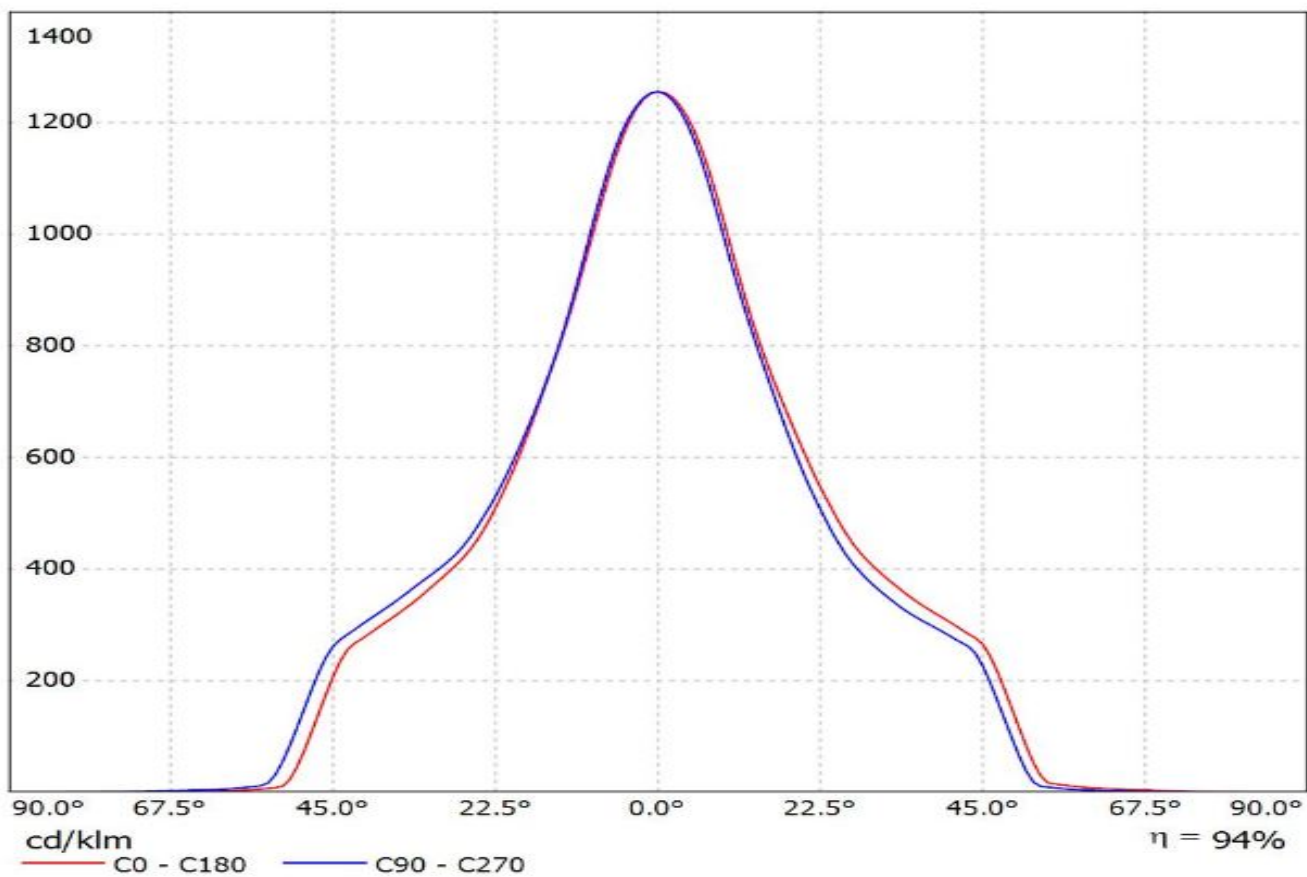

Luminaire: LEDiL Oy F13660\_ANGELINA-M-B\_(SLE-G5\_LES-19)

Lamps: 1 x Tridonic\_SLE-G5\_LES-19\_1334.47lm@250mA\_P=8.2224W\_I=0.250A

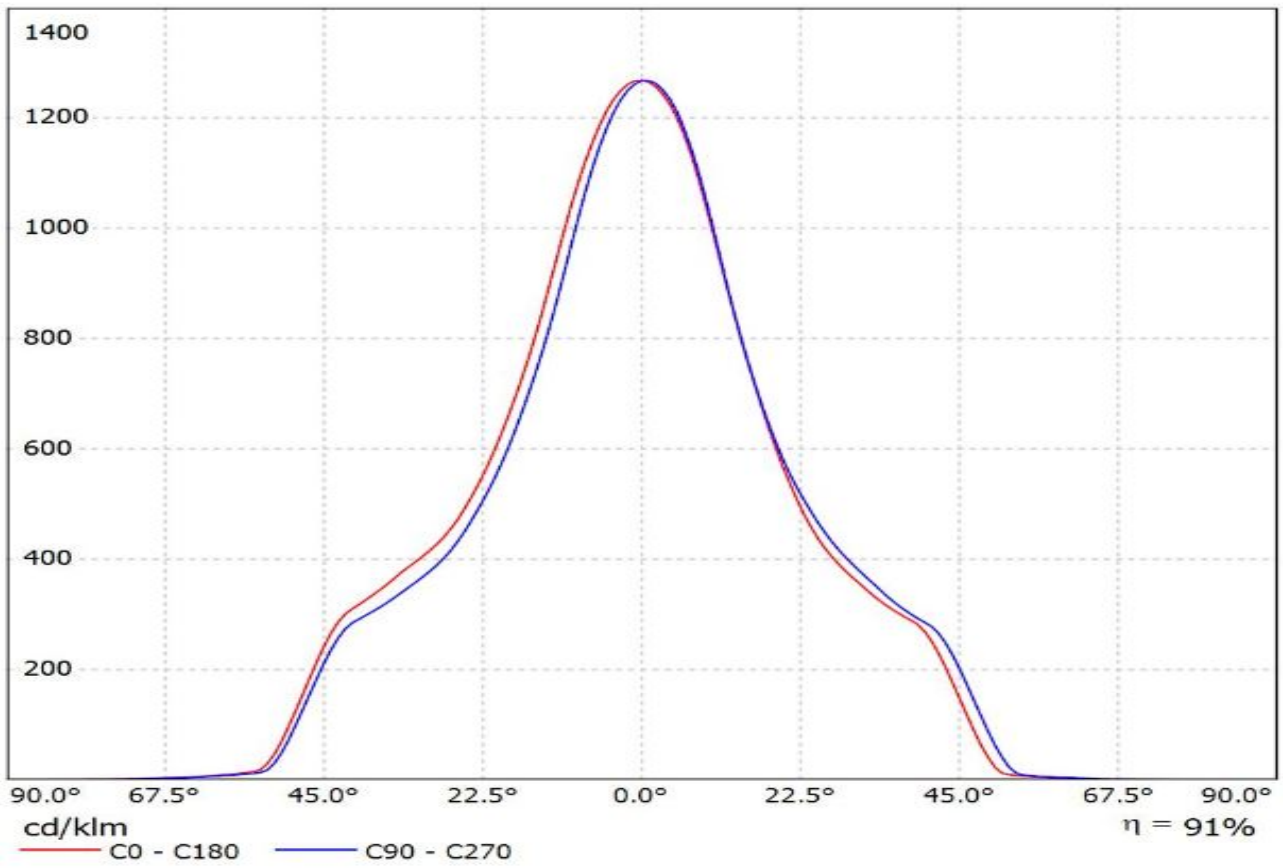

Luminaire: LEDiL Oy F13660\_ANGELINA-M-B\_(SLE-G5\_LES-23)  
Lamps: 1 x Tridonic\_SLE-G5\_LES-23\_1371.74lm@250mA\_P=8.1065W\_I=0.250A

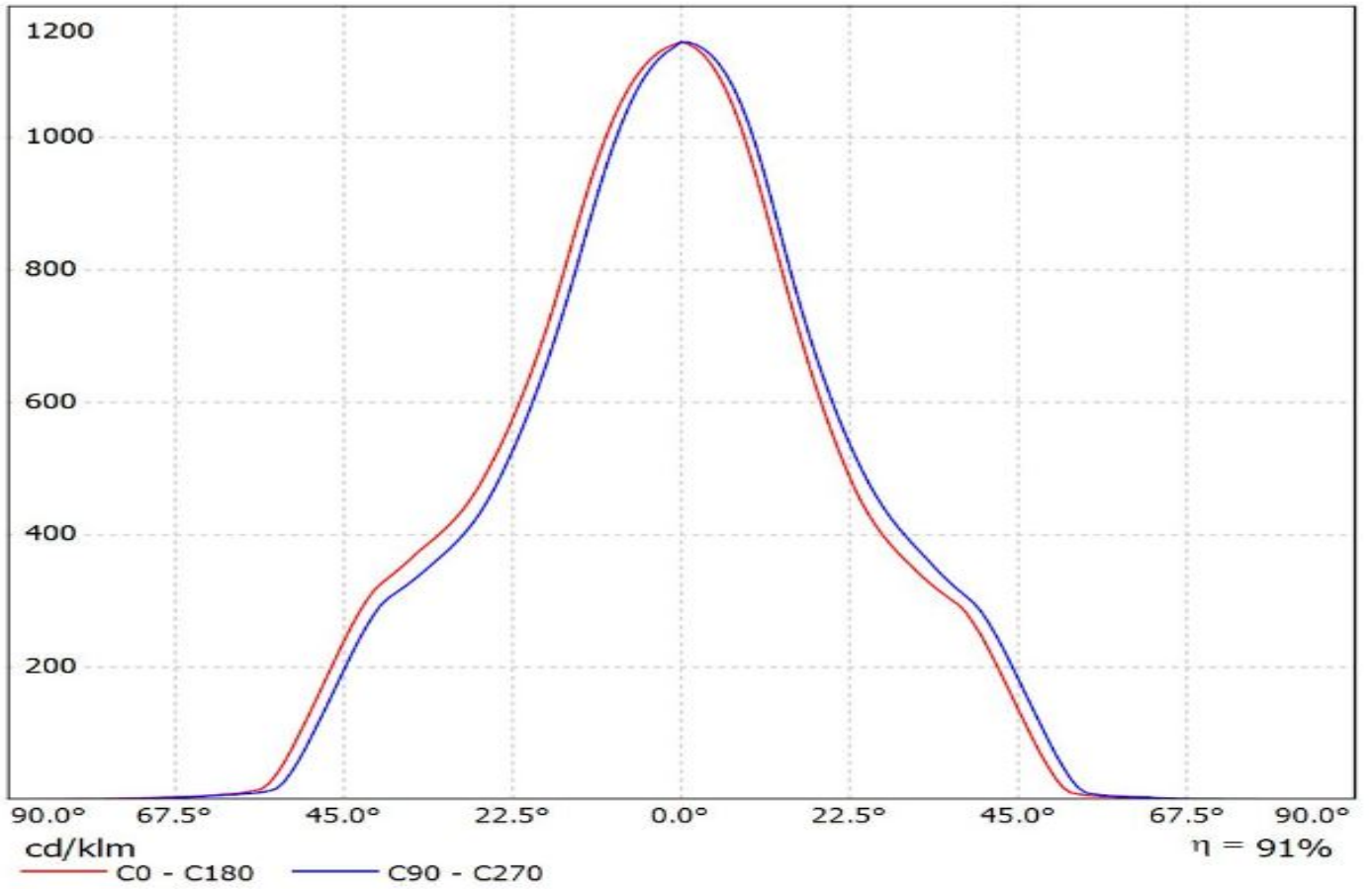

Luminaire: Ledil Oy F13660\_ANGELINA-M-B\_TRIDONIC\_SLE\_G6\_LES19\_H\_SIMULATED  
Lamps: 1 x TRIDONIC SLE G6 LES19 H

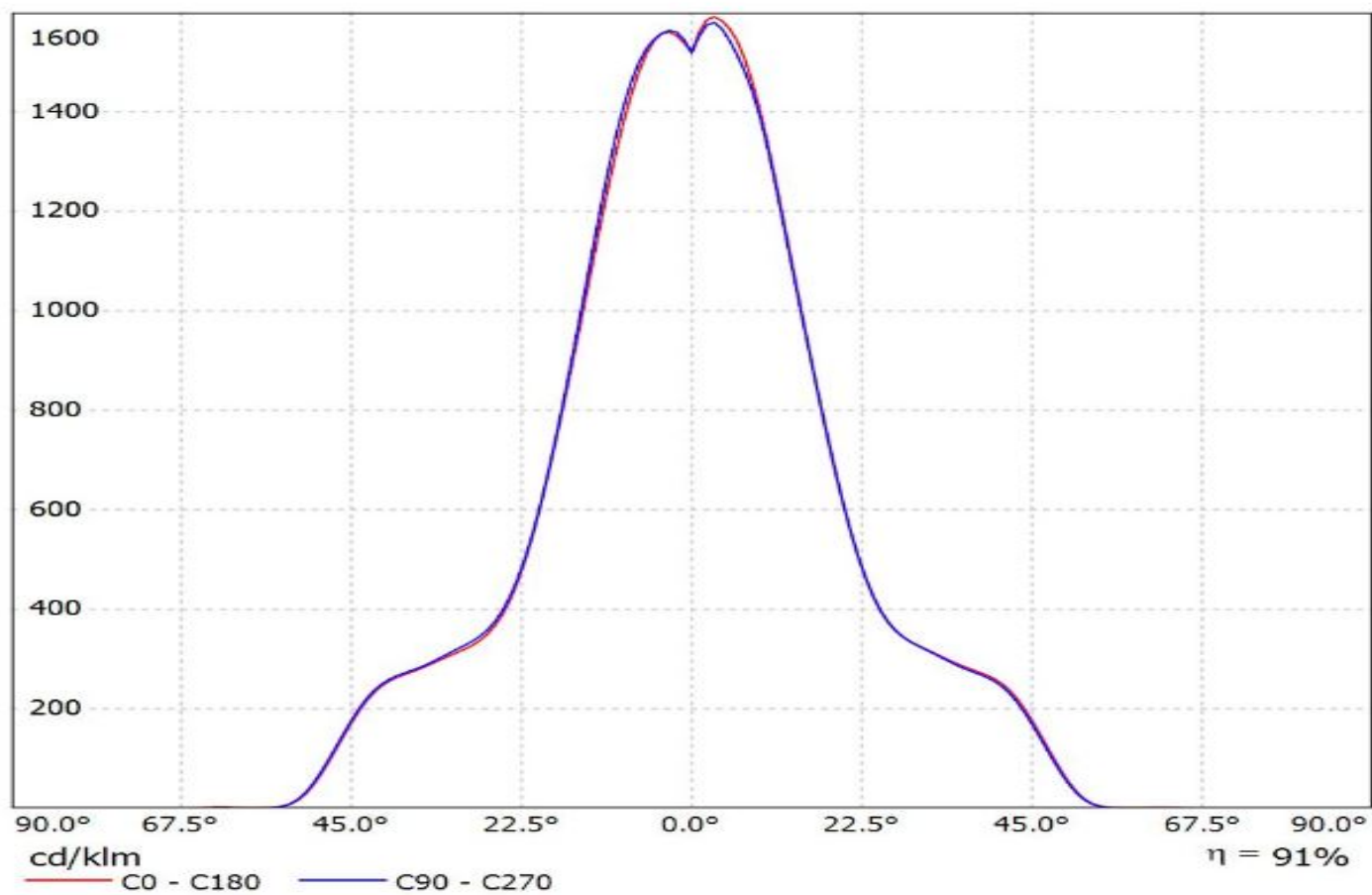

Luminaire: Ledil Oy F13660\_ANGELINA-M-B\_TRIDONIC\_SLE\_G6\_LES23\_H\_SIMULATED  
Lamps: 1 x TRIDONIC SLE G6 LES23 H

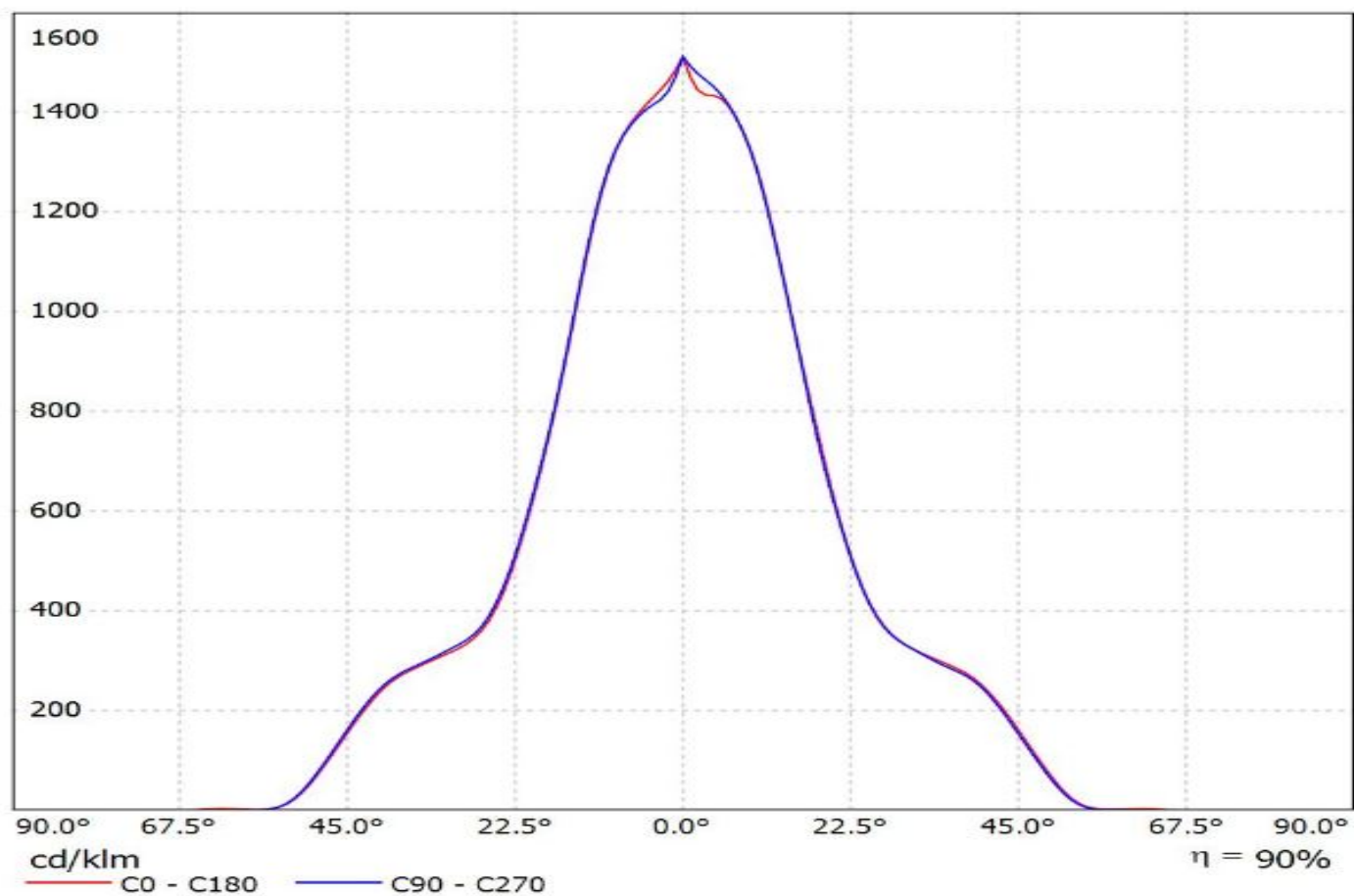

Luminaire: Ledil Oy F13660\_ANGELINA-M-B\_(SLE\_G6\_LES17\_H)\_SIMULATED  
Lamps: 1 x Tridonic SLE G6 LES17 H

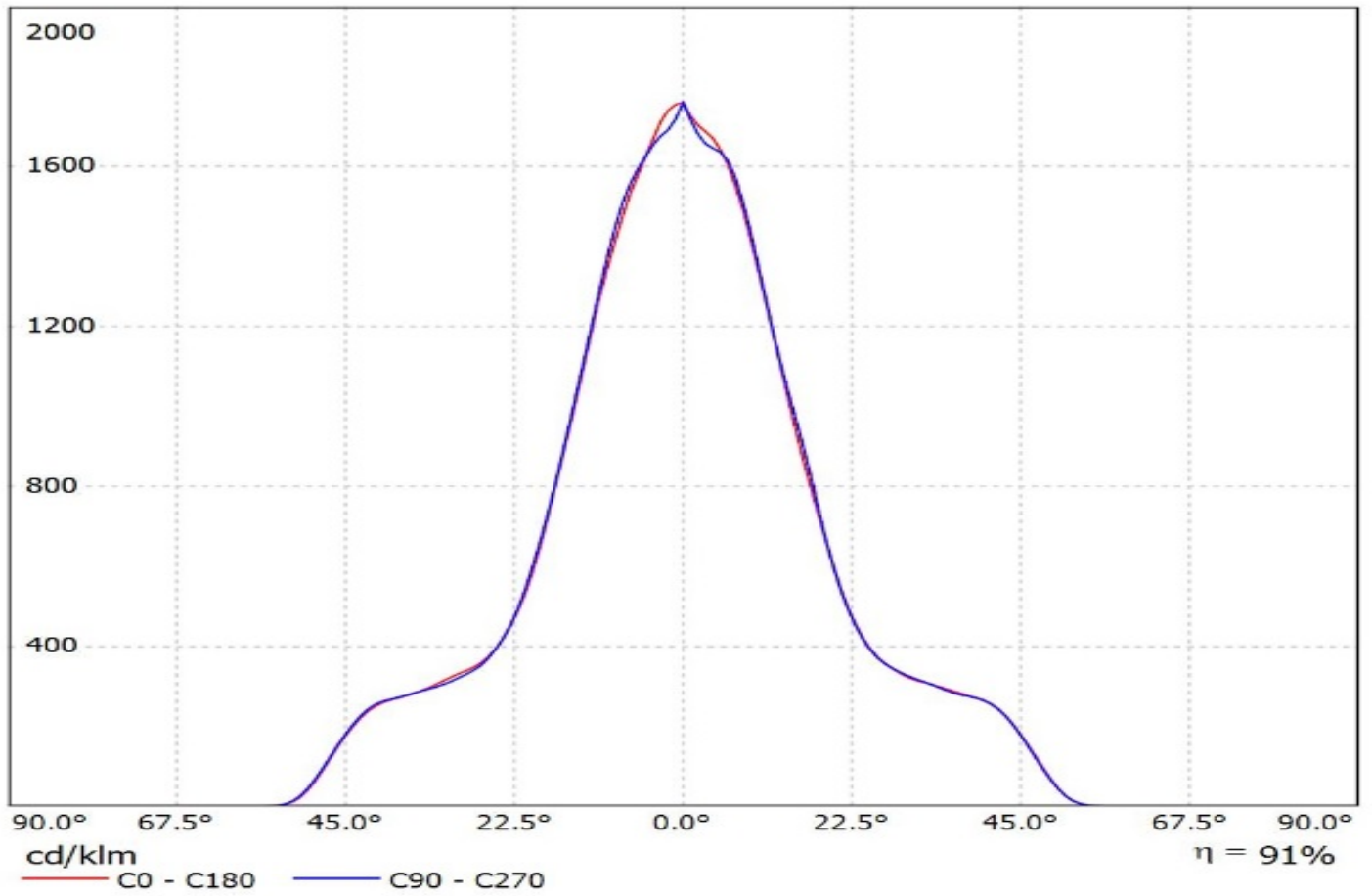

Luminaire: LEDiL Oy C13660\_ANGELINA-M-B\_(BXRA\_ES) Eff. 92%

Lamps: 1 x Bridgelux BXRA\_ES\_(QQ40\_BXRA-W1202\_1019A-2010) 268lm@250mA\_P=3.36W\_I=250mA

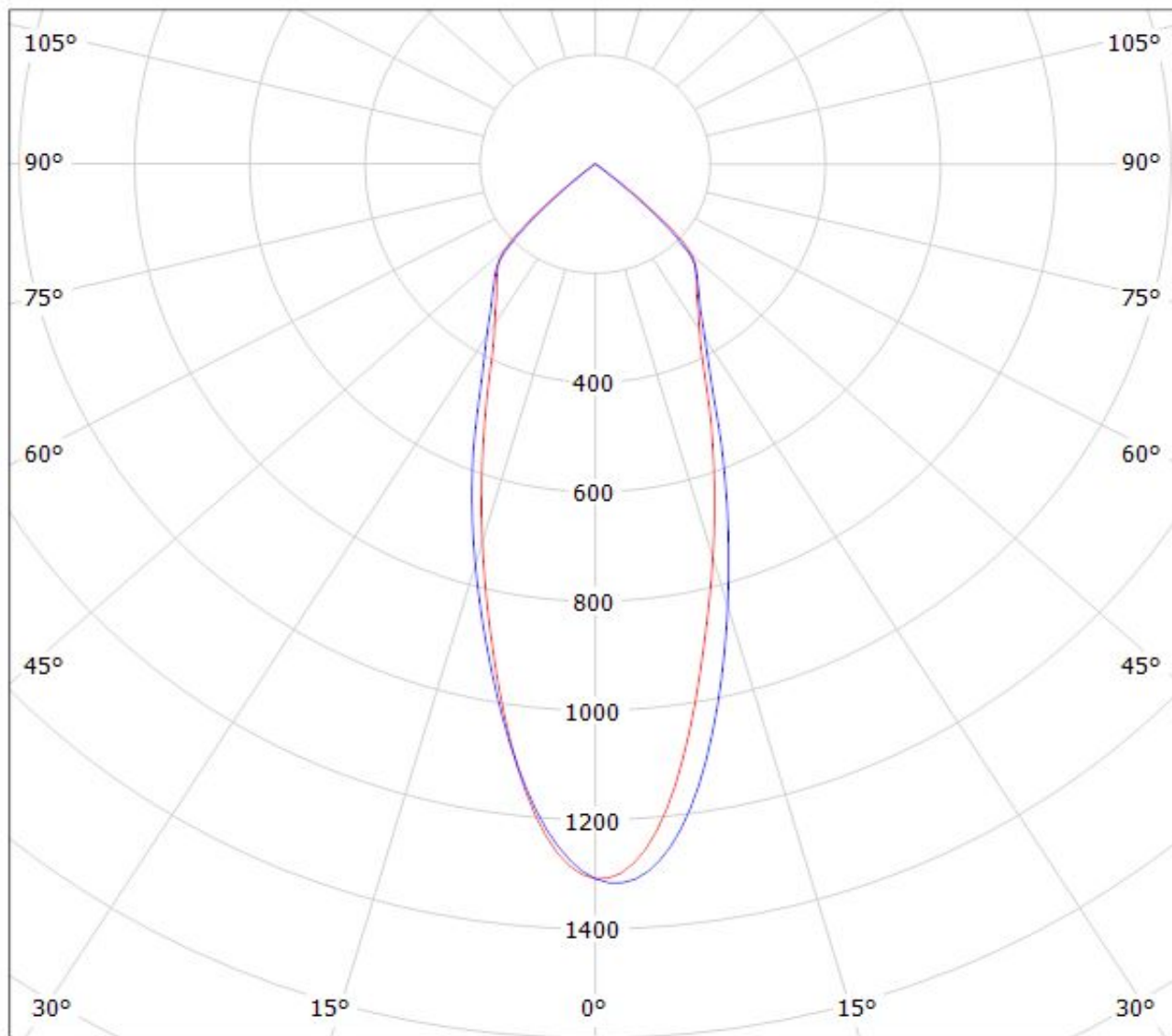

cd/klm

$\eta = 92\%$

— C0 - C180

— C90 - C270



Luminaire: Ledil F13660\_ANGELINA-M-B\_(V18+BJB)  
Lamps: 1 x Bridgelux\_V18\_(BXRC-30E4000-F-23)  
\_+47.319.2274\_1094.62lm@250mA\_CCT=3000K\_P=6.875W\_I=0.25A

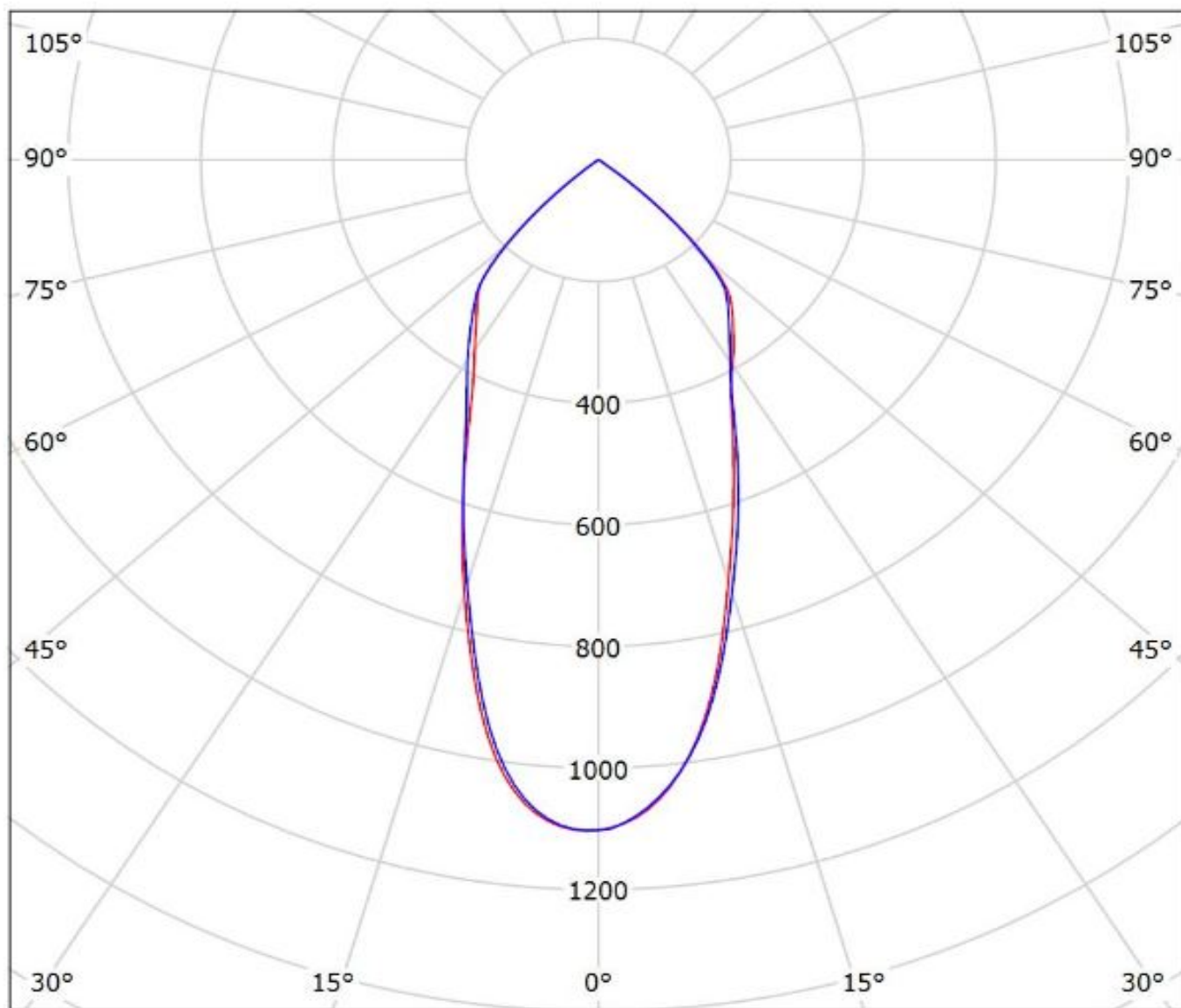

cd/klm

— C0 - C180

— C90 - C270

$\eta = 93\%$

Luminaire: Ledil F13660\_ANGELINA-M-B\_(V15+BJB)

Lamps: 1 x Bridgelux\_V15\_+47.319.2224\_1096.43lm@250mA\_P=8.2647W\_I=0.25A

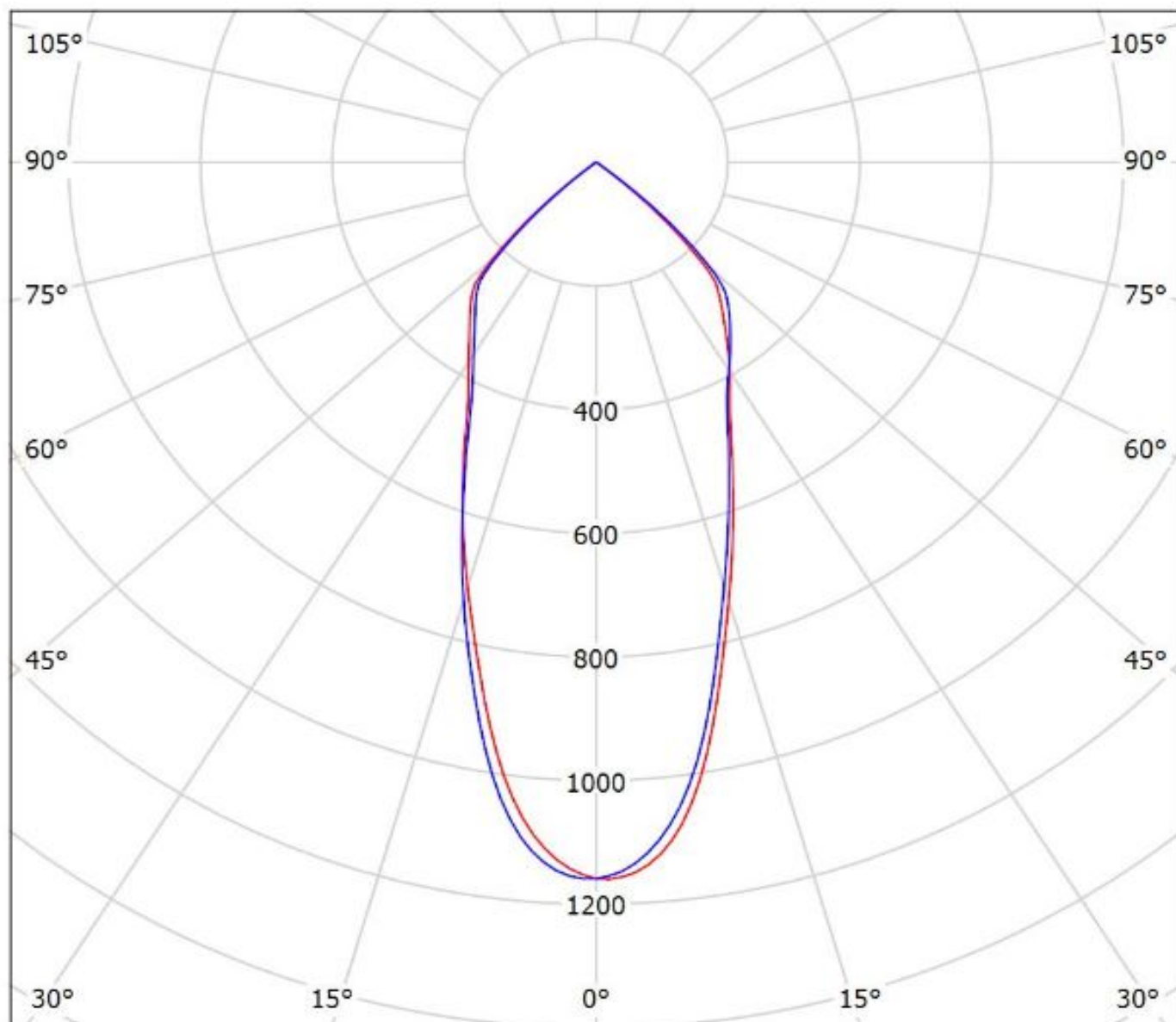

cd/klm

— C0 - C180 — C90 - C270

$\eta = 93\%$

Luminaire: LEDiL Oy F13660\_ANGELINA-M-B\_(V18\_Gen7)+BJB

Lamps: 1 x Bridgelux\_V18\_Gen7\_(BXRE-30E4000-B)+BJB\_47.319.2350\_1384.73lm@250mA\_P=8.09577W\_I=0.25A

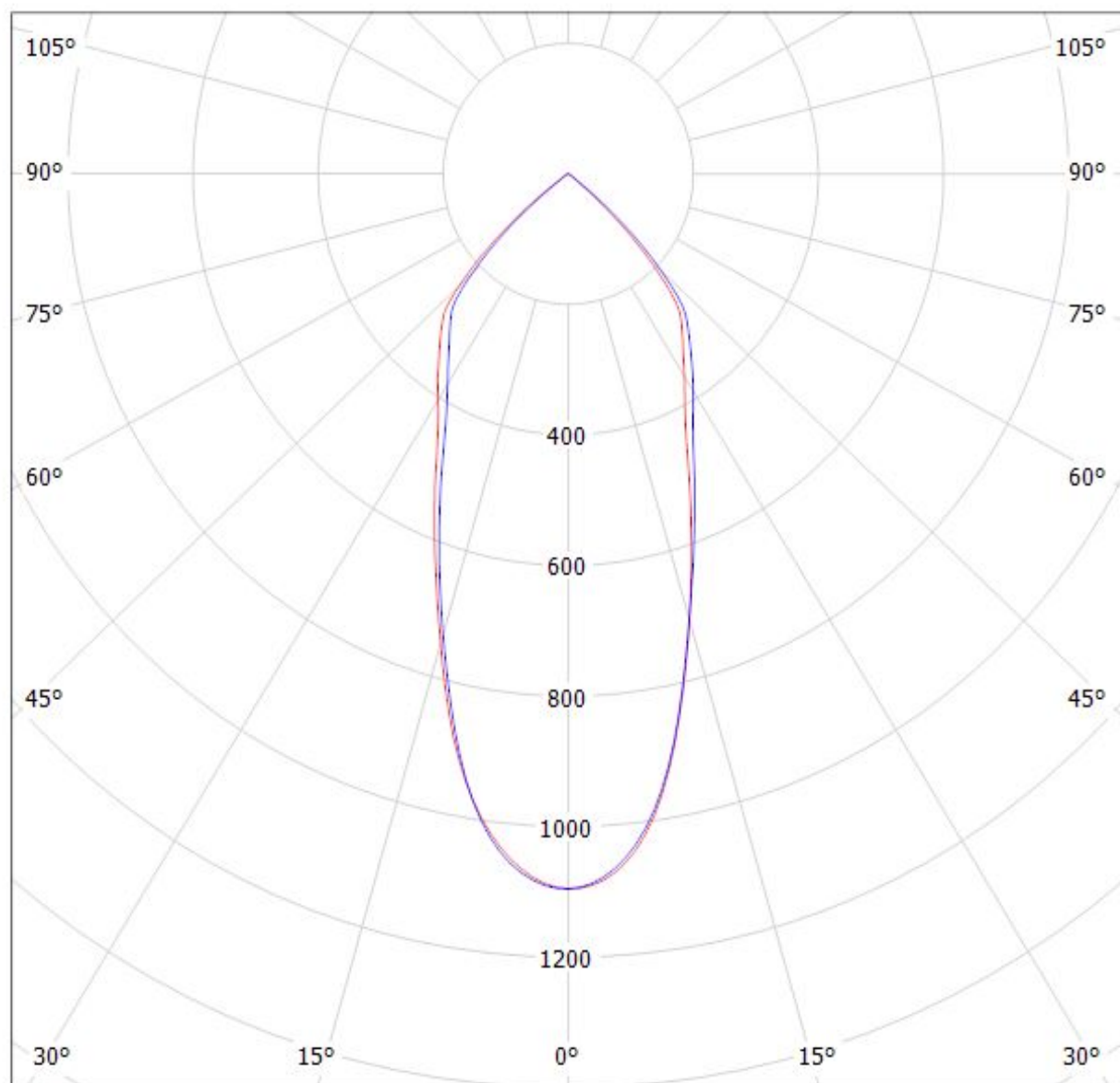

cd/klm

— C0 - C180

— C90 - C270

$\eta = 93\%$

# LEDiL Oy C13660\_ANGELINA-M-B\_(CLL030) Eff.91.7% / LDC (Polar)

Luminaire: LEDiL Oy C13660\_ANGELINA-M-B\_(CLL030) Eff.91.7%

Lamps: 1 x CITIZEN\_CLL030\_(CLL030-1205A5-303H1A7) 797.292lm@250mA CCT=3000K P=8.65307W  
I=249.8mA

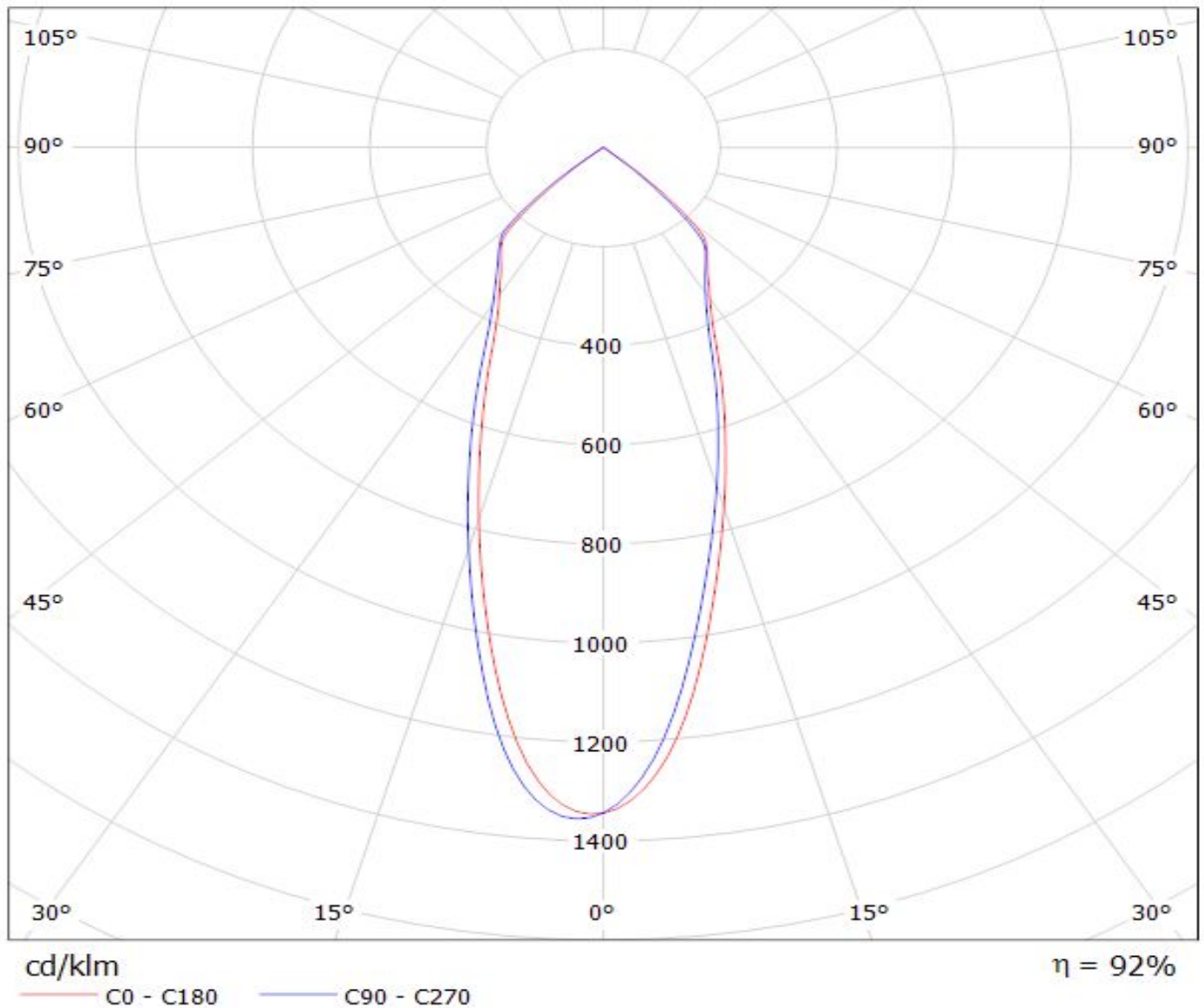

Luminaire: LEDiL Oy F13660\_ANGELINA-M-B\_(CLU034)

Lamps: 1 x Citizen\_CLU034\_(CLU034-1205B8-303M1A2)\_1159.11lm@250mA\_P=8.46586W\_I=249.9mA

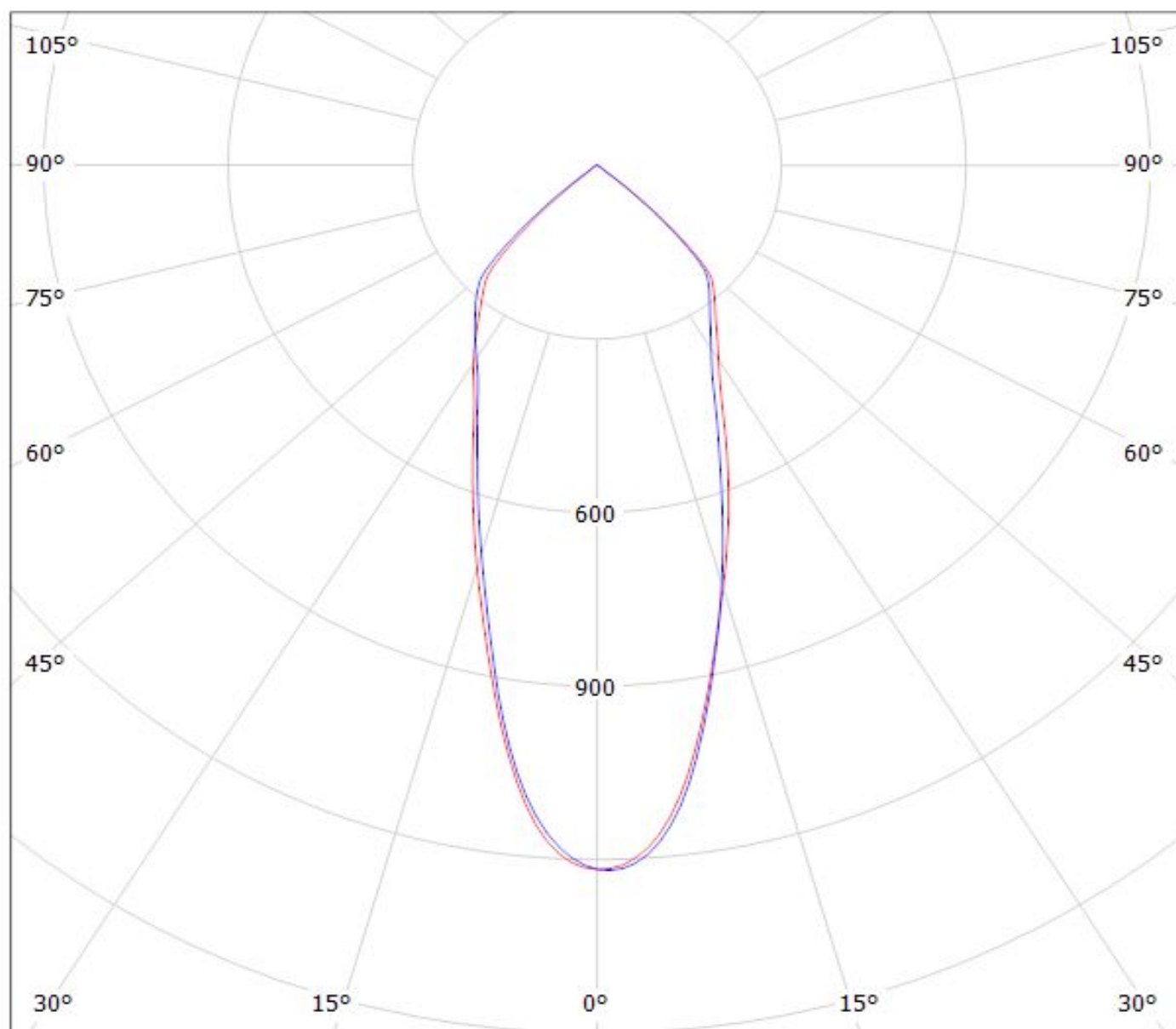

cd/klm

— C0 - C180

— C90 - C270

$\eta = 94\%$

Luminaire: LEDiL Oy F13660\_ANGELINA-M-B\_(CLU044)

Lamps: 1 x Citizen\_CLU044\_(CLU044-1212B8-303M1A2)\_1300.9lm@250mA\_P=8.14849W\_I=249.9mA

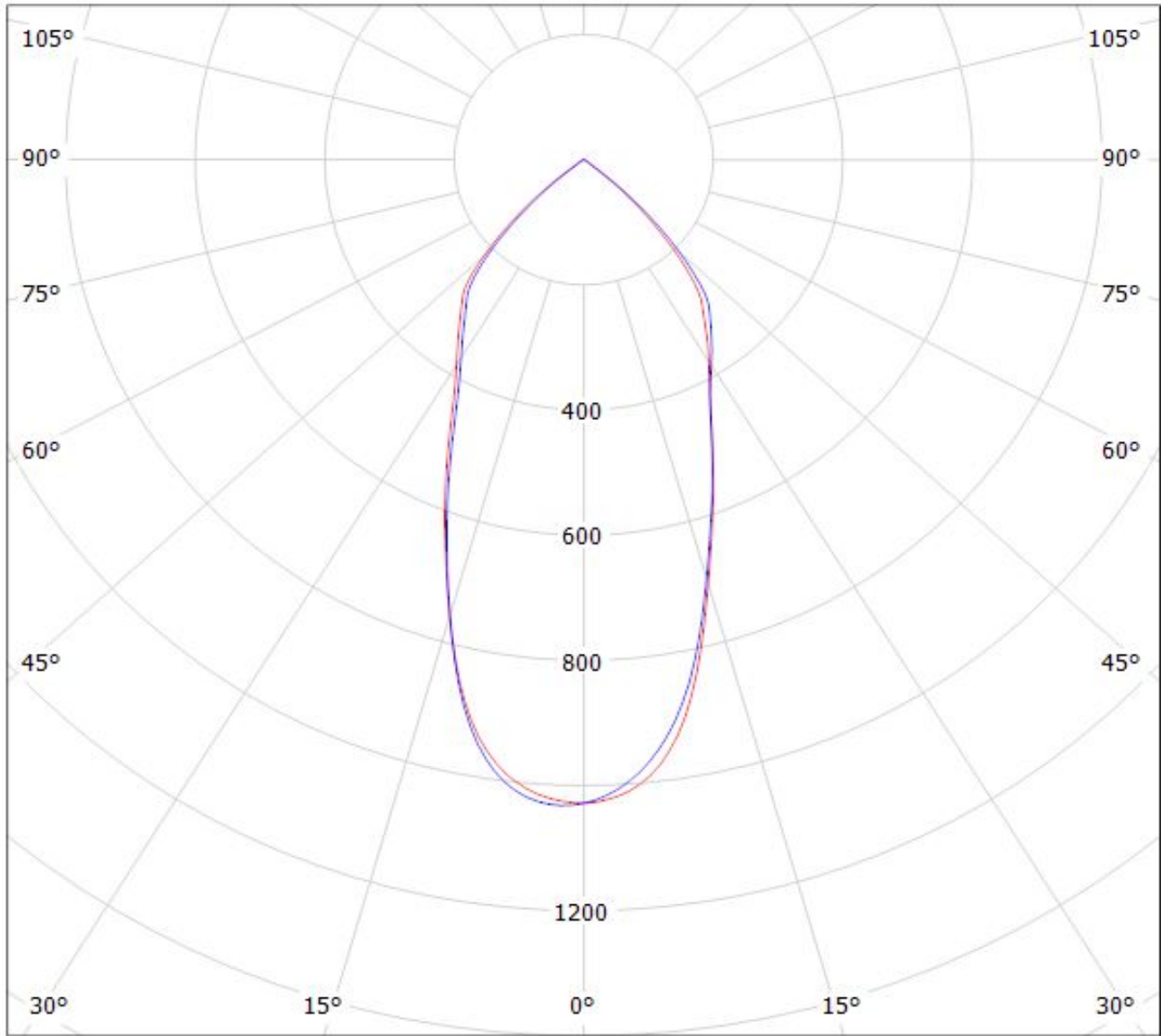

cd/klm

— C0 - C180    — C90 - C270

$\eta = 92\%$



Luminaire: Ledil F13660\_ANGELINA-M-B\_(CITIZEN\_CLU720)  
Lamps: 1 x CITIZEN\_CLU720\_(CLU720-1206B8-273M2)  
\_1320.42lm@250mA\_CCT=2700K\_P=8.35W\_I=0.25A

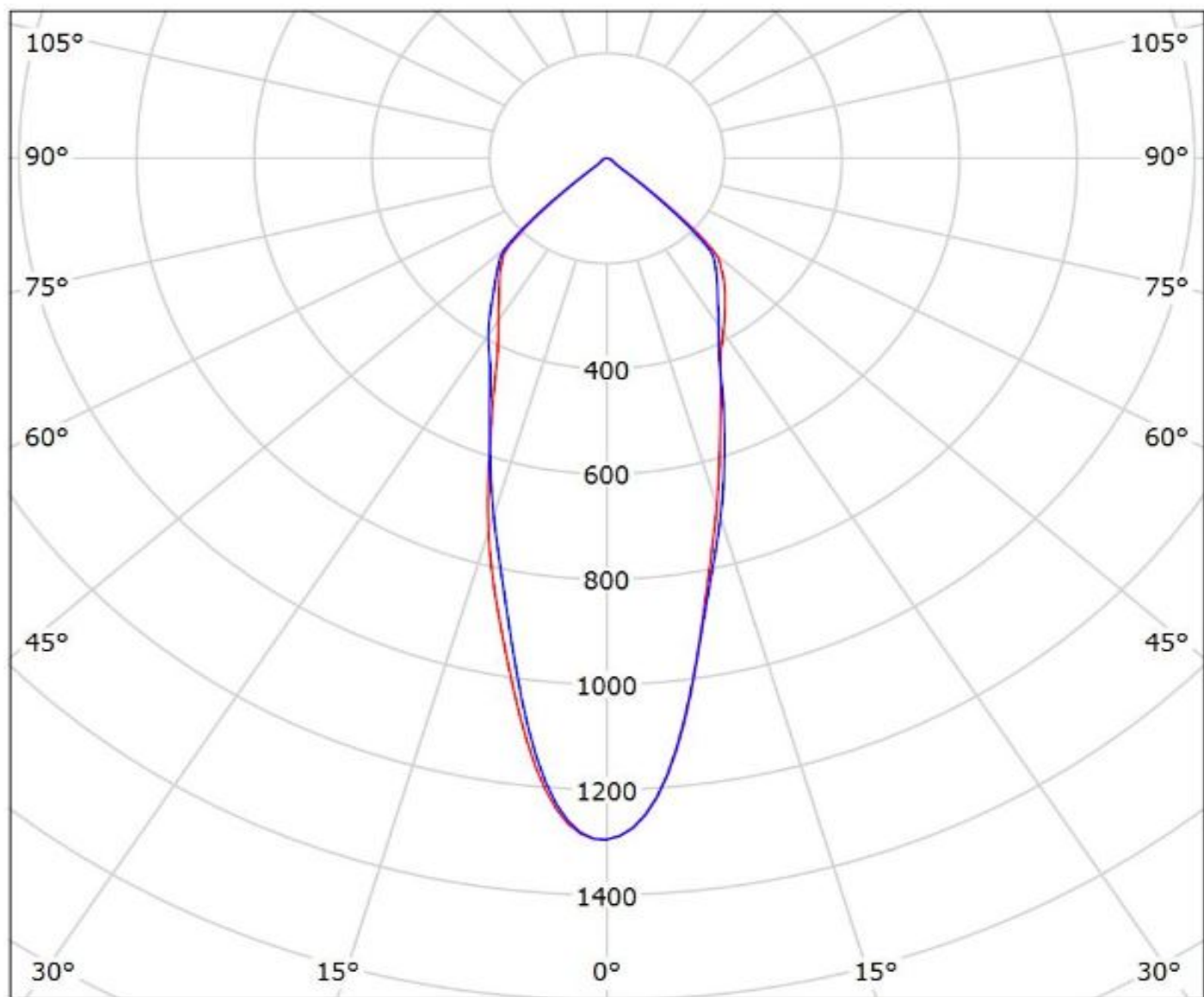

cd/klm

— C0 - C180    — C90 - C270

$\eta = 95\%$

Luminaire: LEDiL Oy F13660\_ANGELINA-M-B\_(CITIZEN\_CLU720)

Lamps: 1 x CITIZEN\_CLU720\_(BJB: 47.319.2020)\_1214.68lm@250mA\_CCT=2700K\_P=8.31842W\_I=0.25A

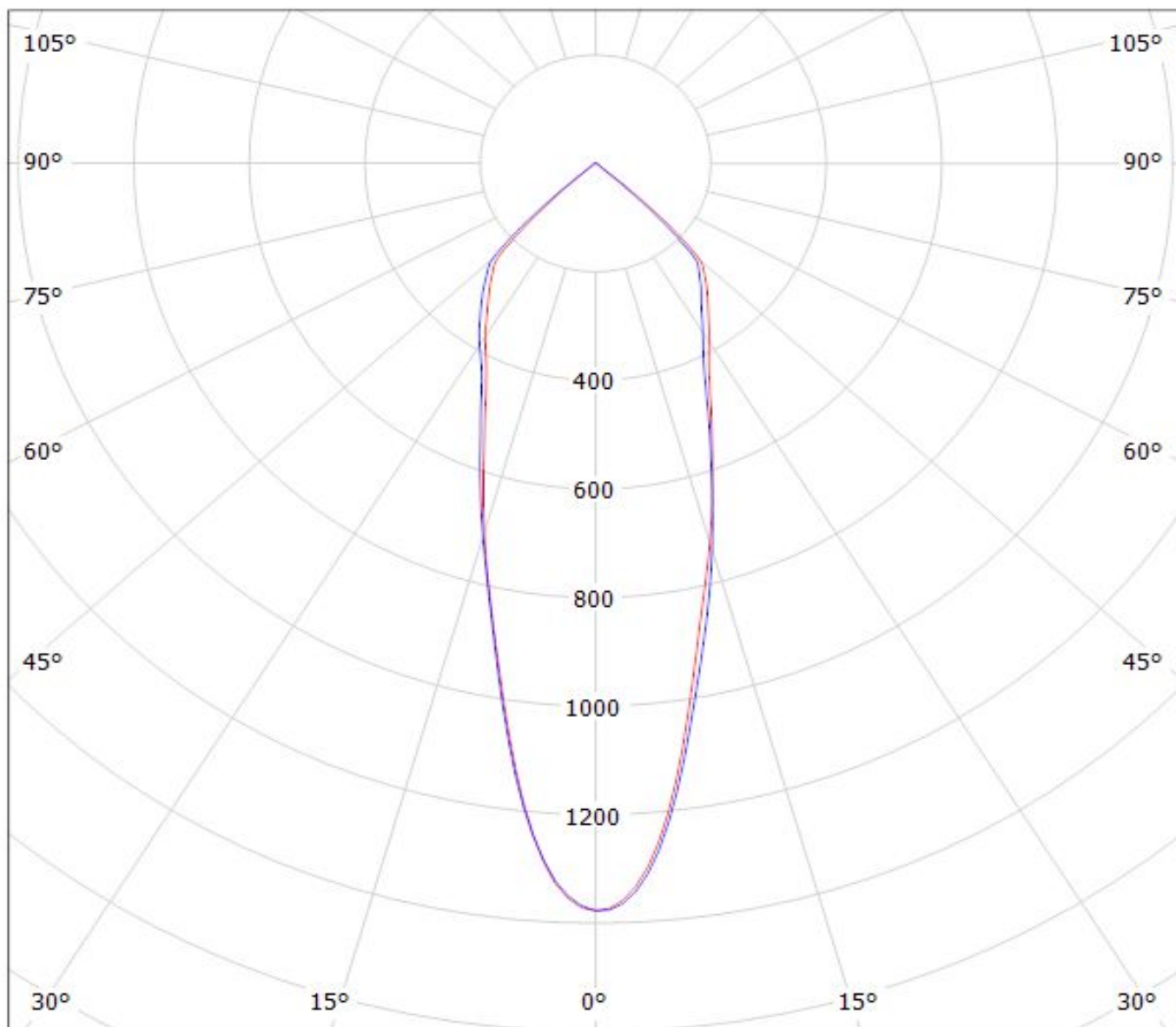

cd/klm

— C0 - C180

— C90 - C270

$\eta = 94\%$



Luminaire: LEDiL Oy F13660\_ANGELINA-M-B\_(CXA30)

Lamps: 1 x Cree\_CXA30\_(CXA3050-3C0-Y2-N0H)\_1395.36lm@250mA\_P=8.20318W\_I=249.8mA

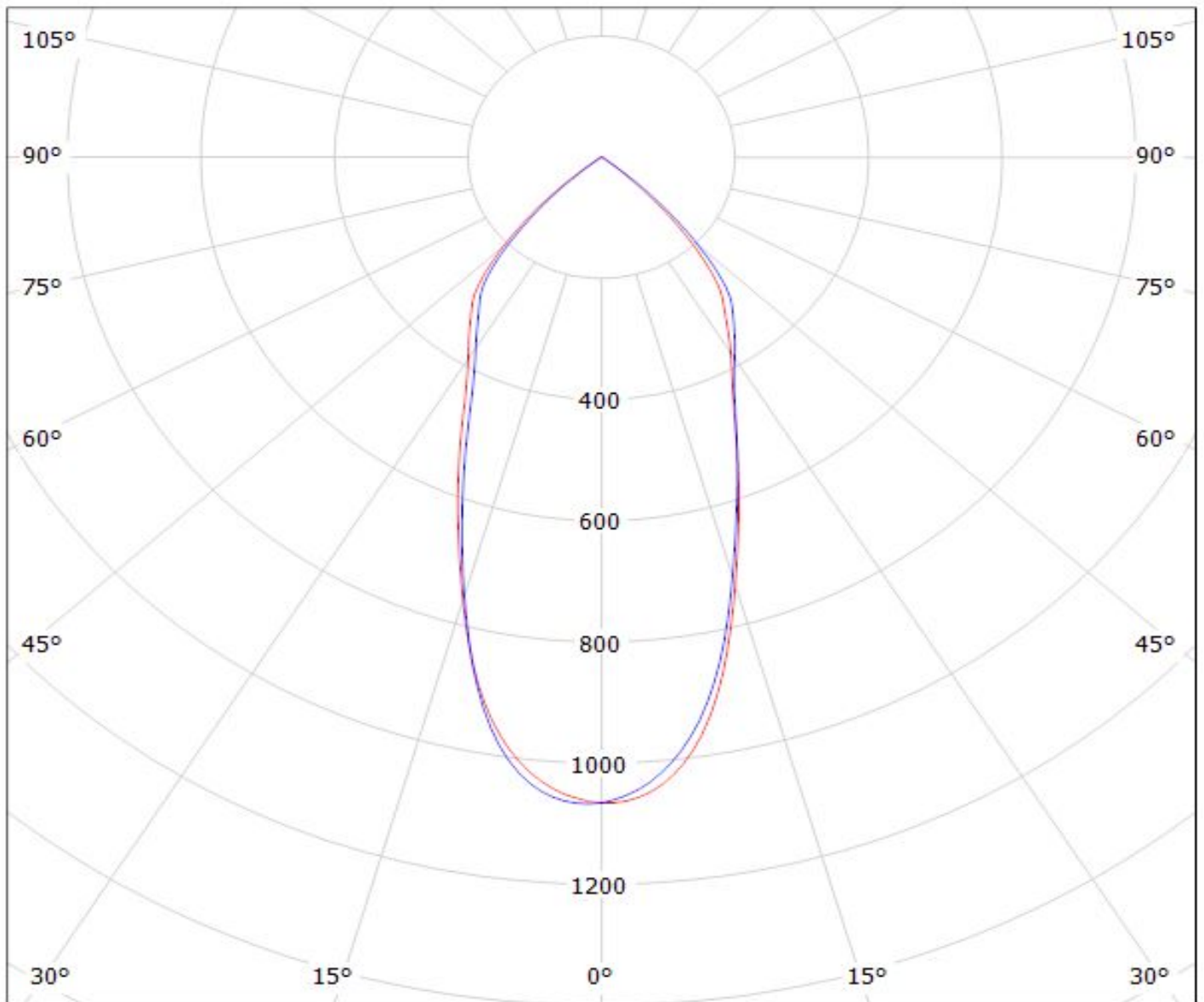

cd/klm

— C0 - C180

— C90 - C270

$\eta = 91\%$

Luminaire: LEDiL Oy F13660\_ANGELINA-M-B\_(CXA2590)  
Lamps: 1 x CREE\_CXA2590\_(CXA2590-30F-Z4-RPH-00001)  
\_837.275lm@100mA\_CCT=3000K\_P=6.36316W\_I=100.1mA

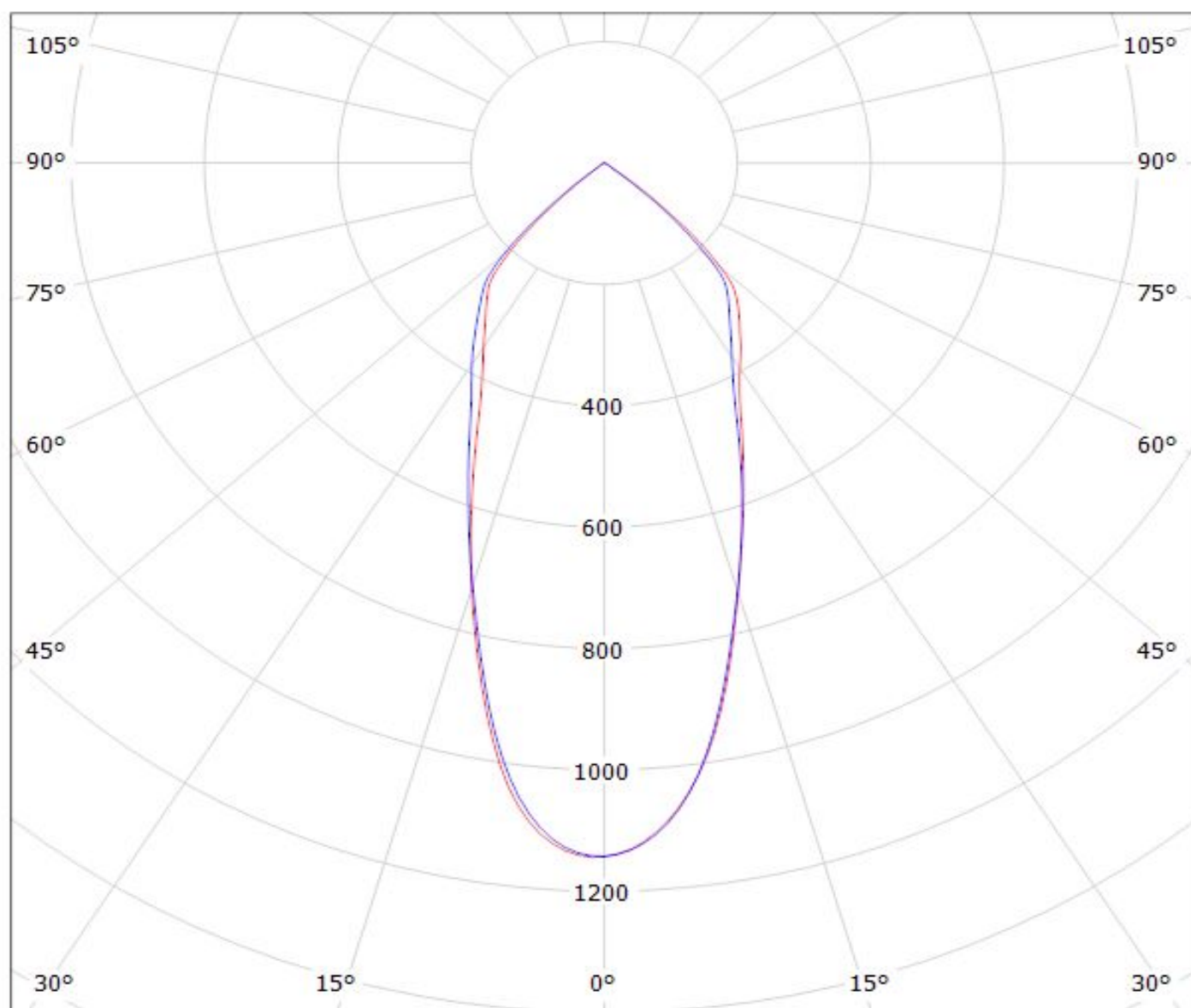

cd/klm

— C0 - C180

— C90 - C270

$\eta = 93\%$

Luminaire: Ledil F13660\_ANGELINA-M-B\_(CXB2540+\_BJB\_47.319.2140)  
Lamps: 1 x CREE\_CXB2540\_(-40G-W4-N0H-00002)  
+\_BJB\_47.319.2140\_1412.99lm@250mA\_CCT=40000K\_P=8.1310W\_I=0.25A

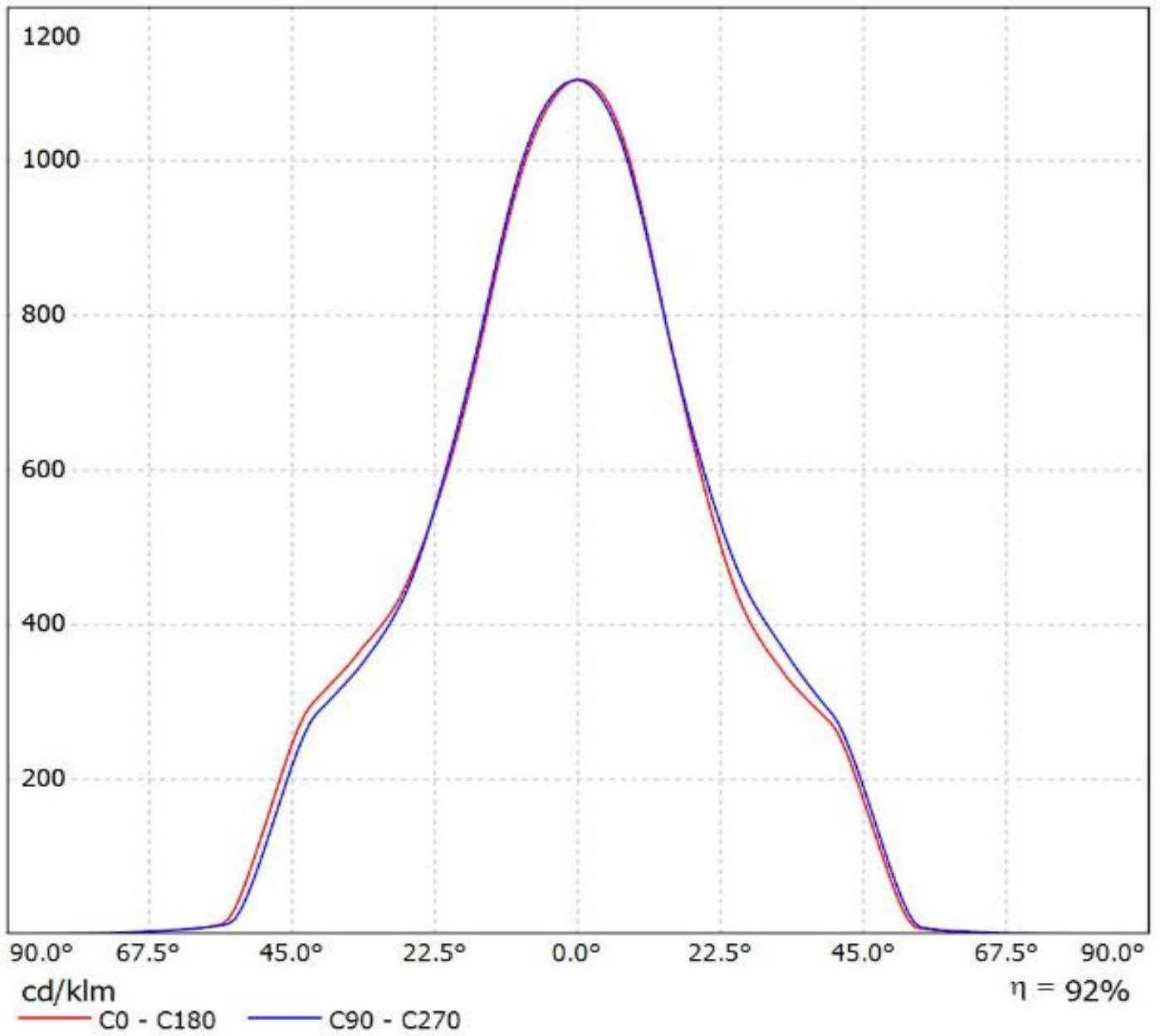

# Ledil F13660\_ANGELINA-M-B\_(COB\_10W)\_(BJB\_47\_319\_2080) / LDC (Polar)

Luminaire: Ledil F13660\_ANGELINA-M-B\_(COB\_10W)\_(BJB\_47\_319\_2080)  
Lamps: 1 x LG\_COB\_10W\_(LEMWM18580LG00)\_(BJB\_47.319.2080)  
\_947.453lm@250mA\_P=9.342W\_I=0.250A

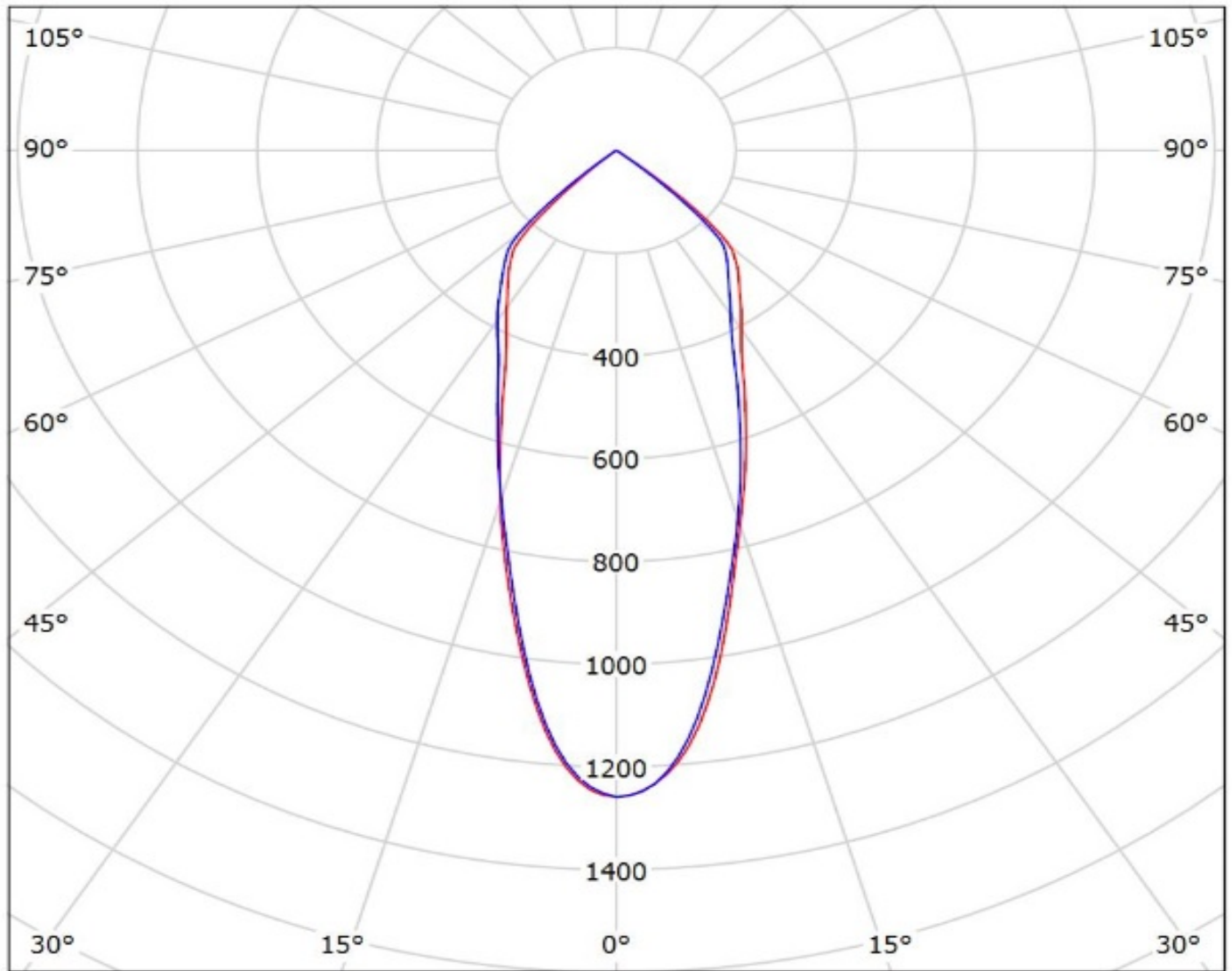

cd/klm

— C0 - C180 — C90 - C270

$\eta = 93\%$

Luminaire: LEDiL Oy F13660\_ANGELINA-M-B\_(LG\_COB\_10W)

Lamps: 1 x LG\_COB\_10W\_(LEMWM18580LG00)\_917.757lm@250mA\_P=9.31304W\_I=249.8mA

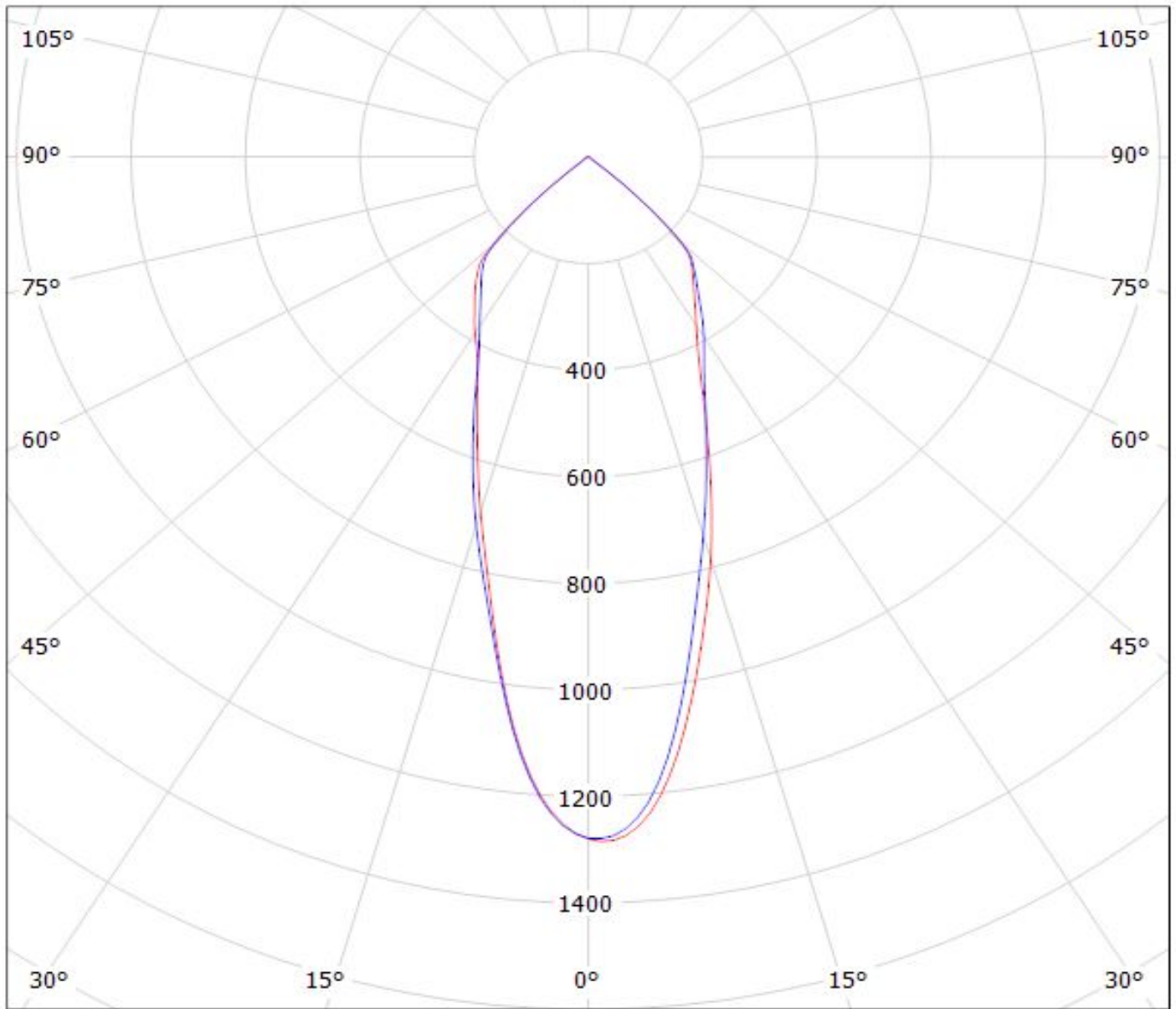

cd/klm

— C0 - C180

— C90 - C270

$\eta = 94\%$



Luminaire: LEDiL Oy F13660\_ANGELINA-M-B\_(COB\_40W)

Lamps: 1 x LG\_COB\_40W\_1163.31lm@250mA\_CCT=3000K\_P=8.04906W\_I=249.8mA

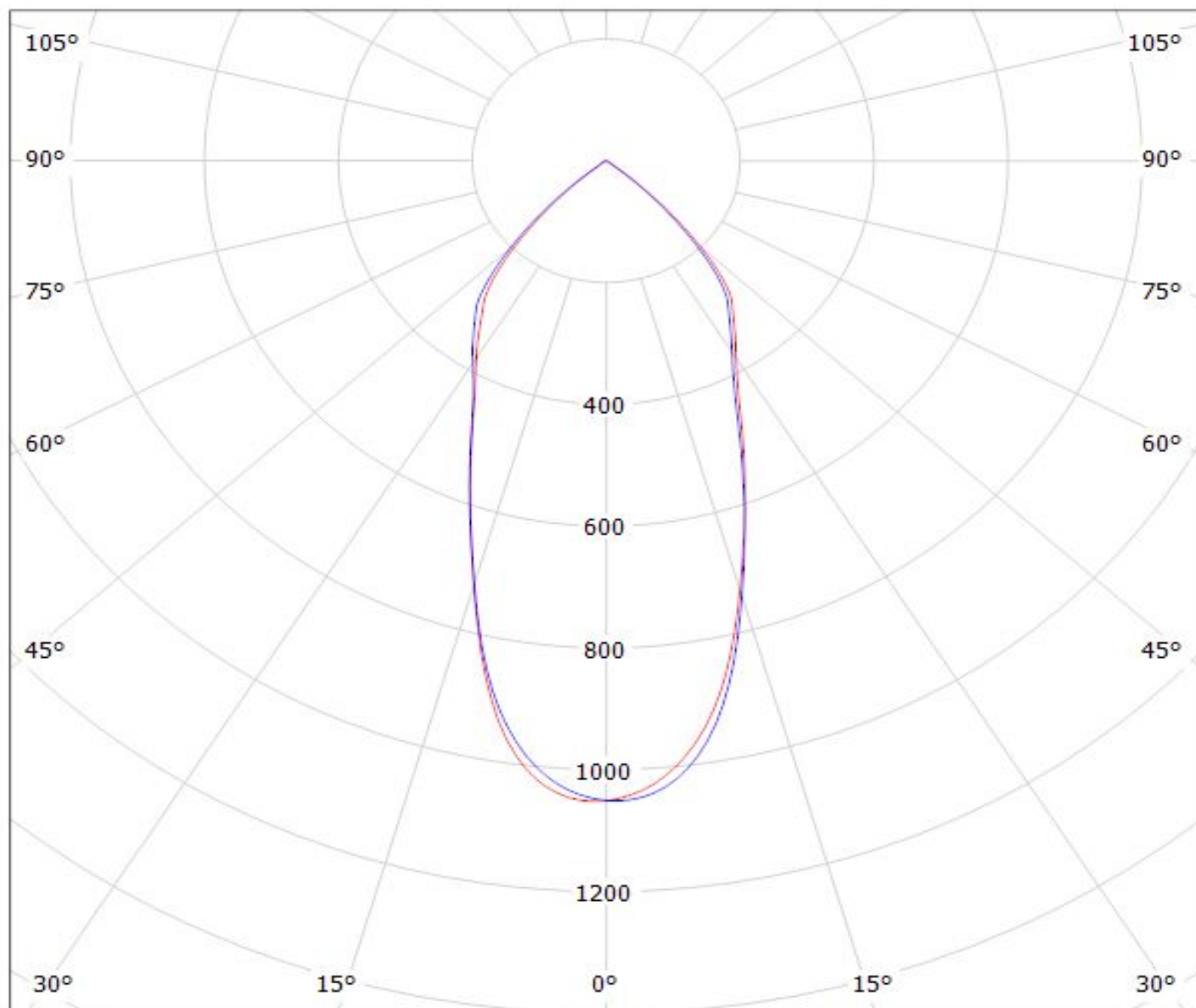

cd/klm

— C0 - C180

— C90 - C270

$\eta = 90\%$

# Ledil F13660\_ANGELINA-M-B\_(Luxeon\_K16)\_(47\_319\_2070) / LDC (Polar)

Luminaire: Ledil F13660\_ANGELINA-M-B\_(Luxeon\_K16)\_(47\_319\_2070)

Lamps: 1 x Philips\_Lumileds\_Luxeon\_K16\_(BJB.47.319.2070)

\_1276.25lm@250mA\_P=10.95525W\_I=0.250A

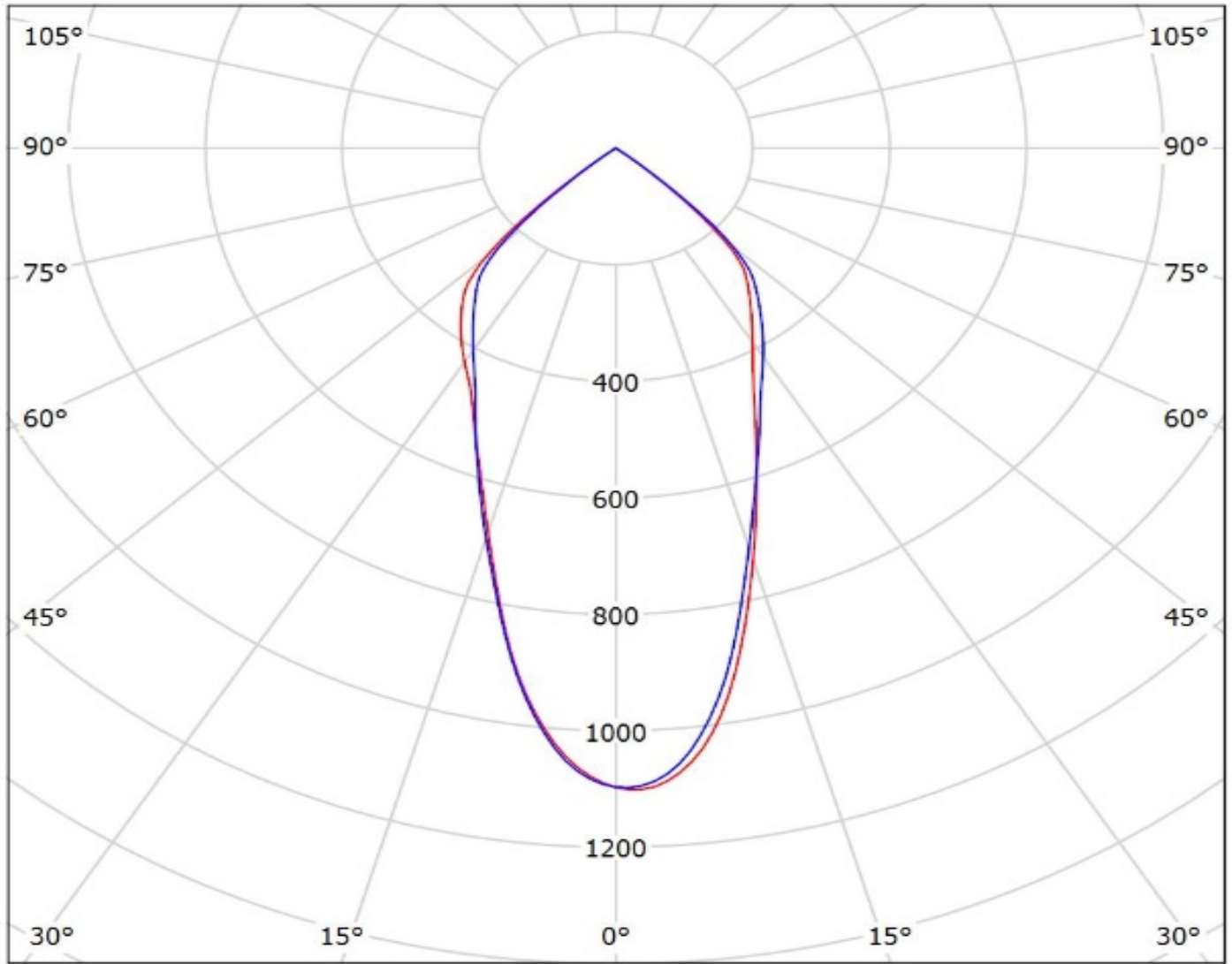

cd/klm

— C0 - C180    — C90 - C270

$\eta = 95\%$

Luminaire: LEDiL Oy F13660\_ANGELINA-M-B\_(Luxeon\_CoB\_1205)

Lamps: 1 x LUXEON\_COB\_1205\_(LHC1-3080-1205)\_1274.35lm@250mA\_CCT=3000K\_P=11.183W\_I=249.8mA

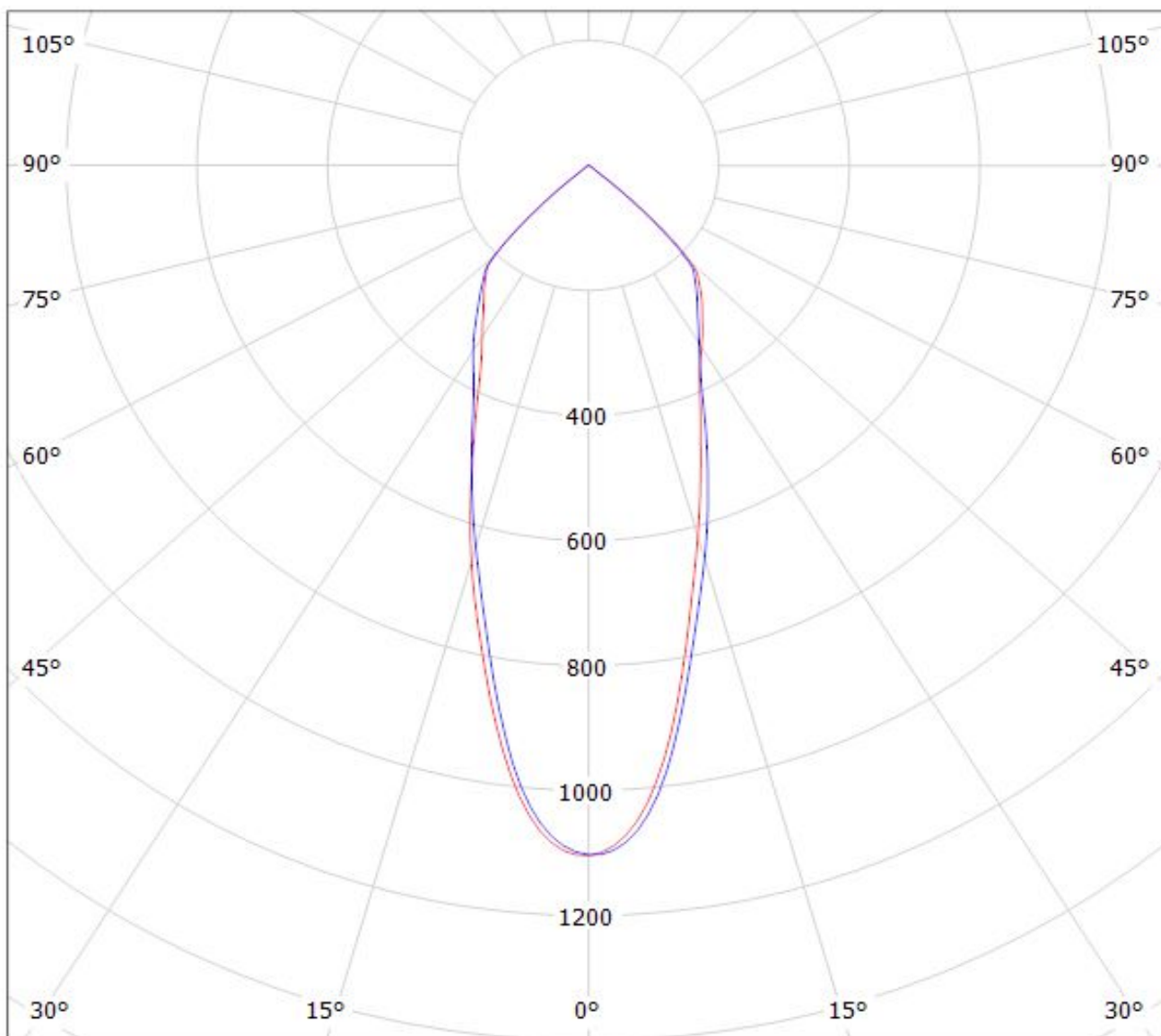

cd/klm

$\eta = 82\%$

— C0 - C180

— C90 - C270



Luminaire: LEDiL Oy F13660\_ANGELINA-M-B\_(Luxeon\_CoB\_1208)  
Lamps: 1 x Luxeon\_CoB\_1208\_1057.71lm@250mA\_P=8.26438W\_I=249.8mA

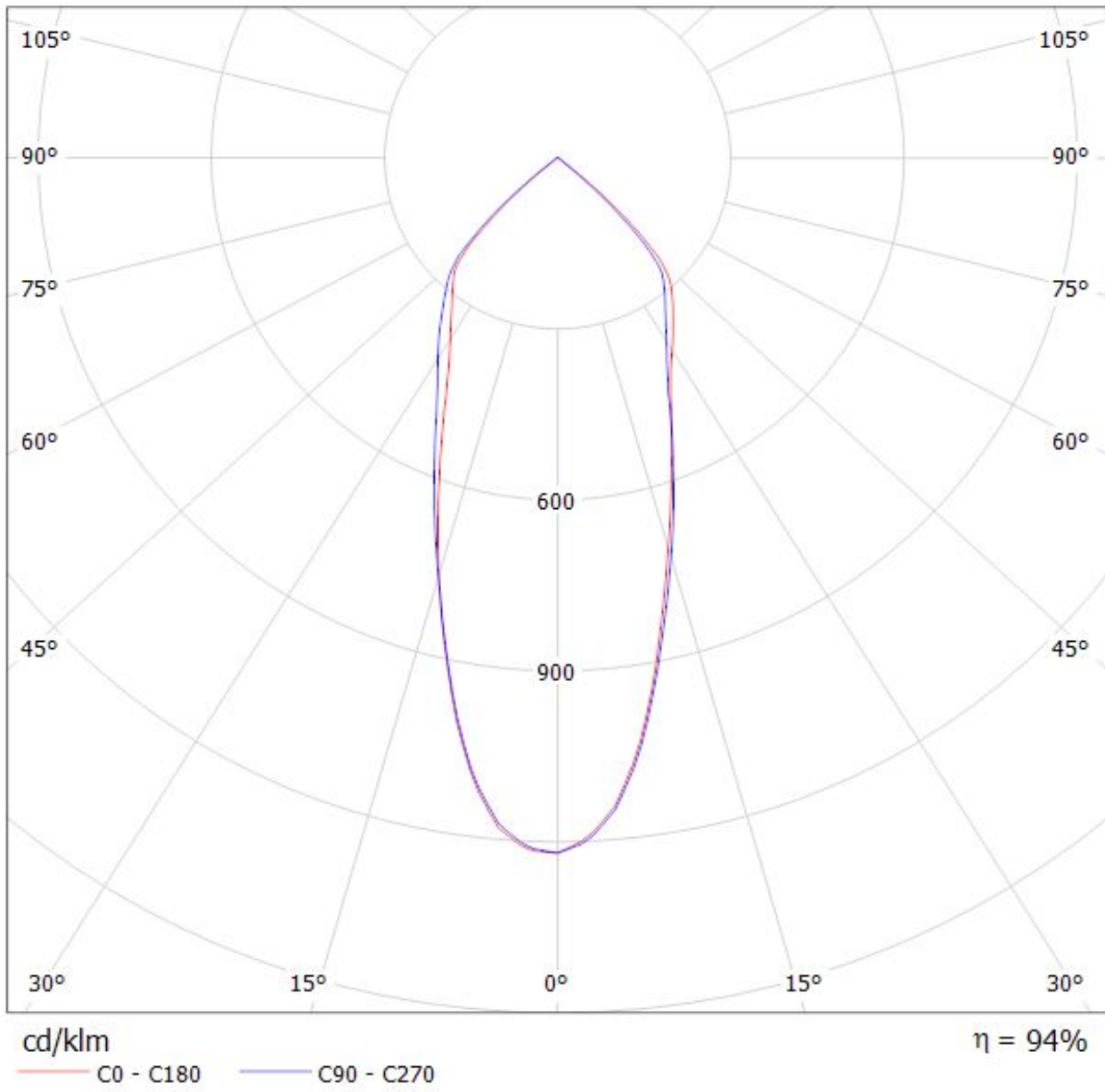

Luminaire: LEDiL Oy F13660\_ANGELINA-M-B\_(Luxeon\_CoB\_1211)  
Lamps: 1 x LUXEON\_COB\_1211\_(LHC1-2790-1211)  
\_923.583lm@250mA\_CCT=2700K\_P=8.00909W\_I=249.8mA

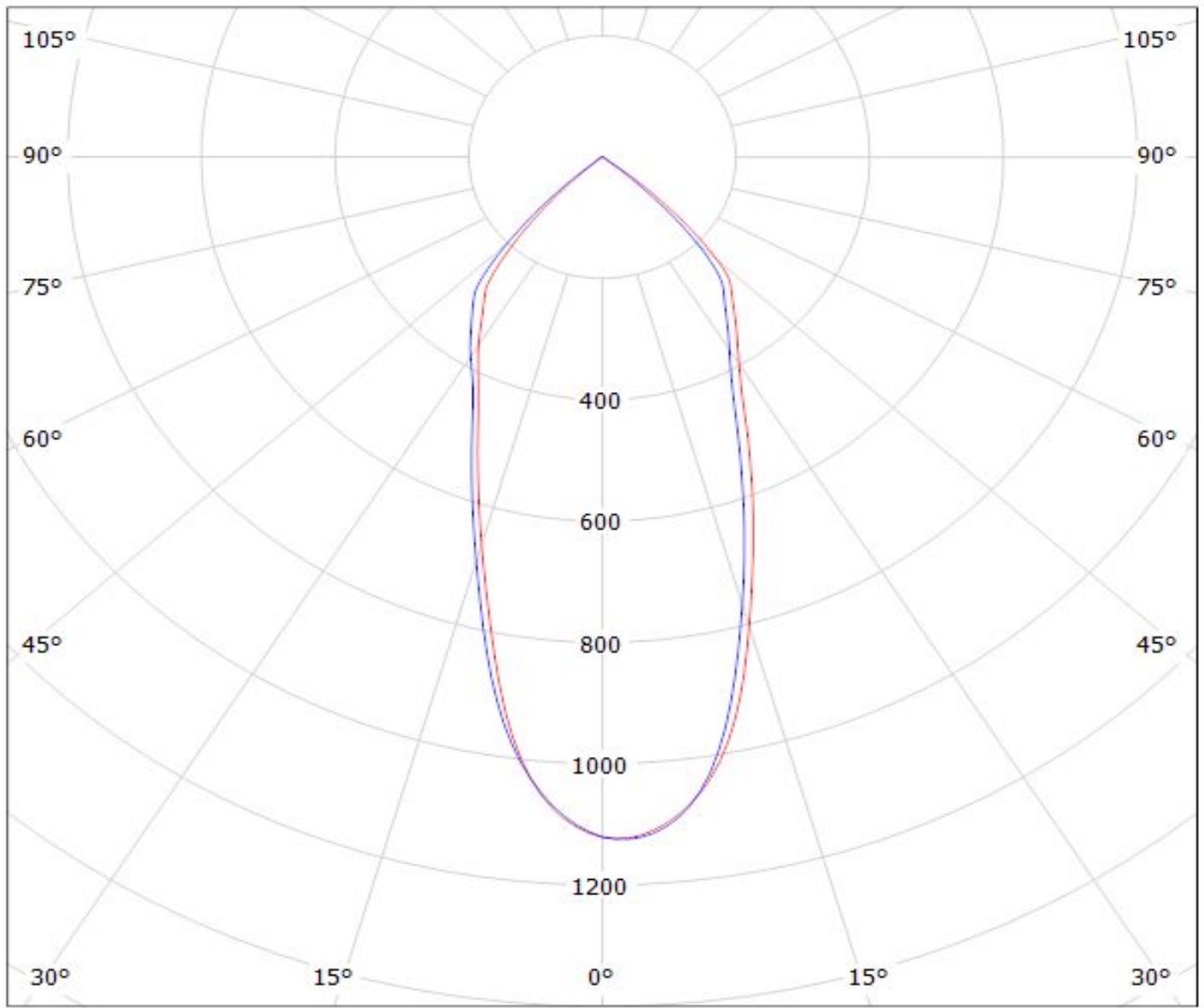

cd/klm

— C0 - C180 — C90 - C270

$\eta = 92\%$

Luminaire: LEDiL Oy F13660\_ANGELINA-M-B\_(Luxeon\_CoB\_1211)\_(BJB2030) 82

Lamps: 1 x Luxeon\_CoB\_1211\_(LHC1-5780-1211)\_(BJB2030)\_1330.16lm@250mA\_P=8.03503W\_I=0.2499A

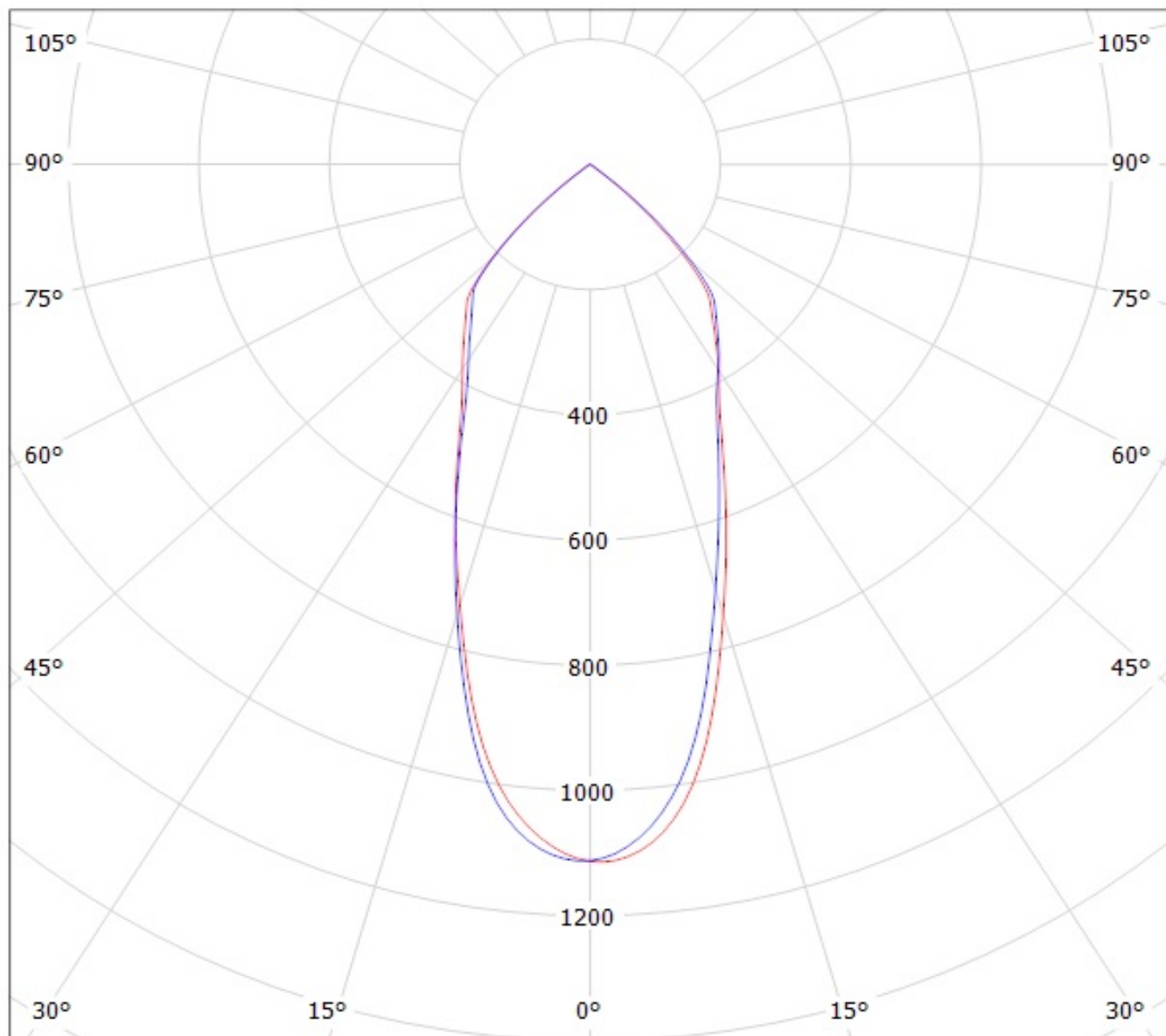

cd/klm

— C0 - C180

— C90 - C270

$\eta = 92\%$

Luminaire: Ledil F13660\_ANGELINA-M-B (CoB\_1216)

Lamps: 1 x Luxeon\_CoB\_1216\_(L2C2-40801216E2300)\_1478.53lm@250mA\_P=8.0068W\_I=0.25A

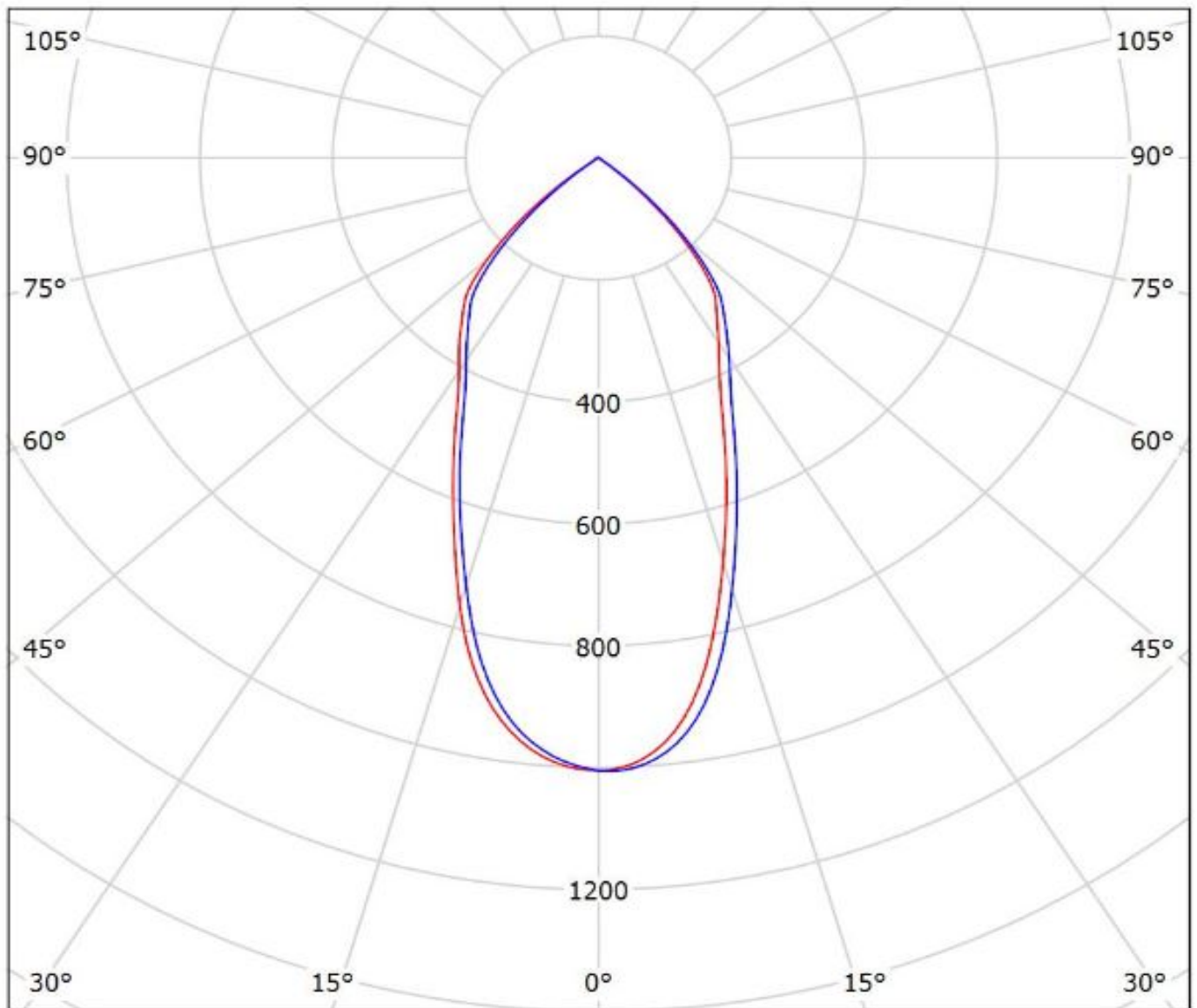

cd/klm

— C0 - C180

— C90 - C270

$\eta = 91\%$

Luminaire: LEDiL Oy F13660\_ANGELINA-M-B\_(CXM-22) Eff.91.8%  
Lamps: 1 x LUMINUS\_CXM-22\_1221.8lm@250mA\_P=8.00809W\_CCT=3000K\_I=249.8mA

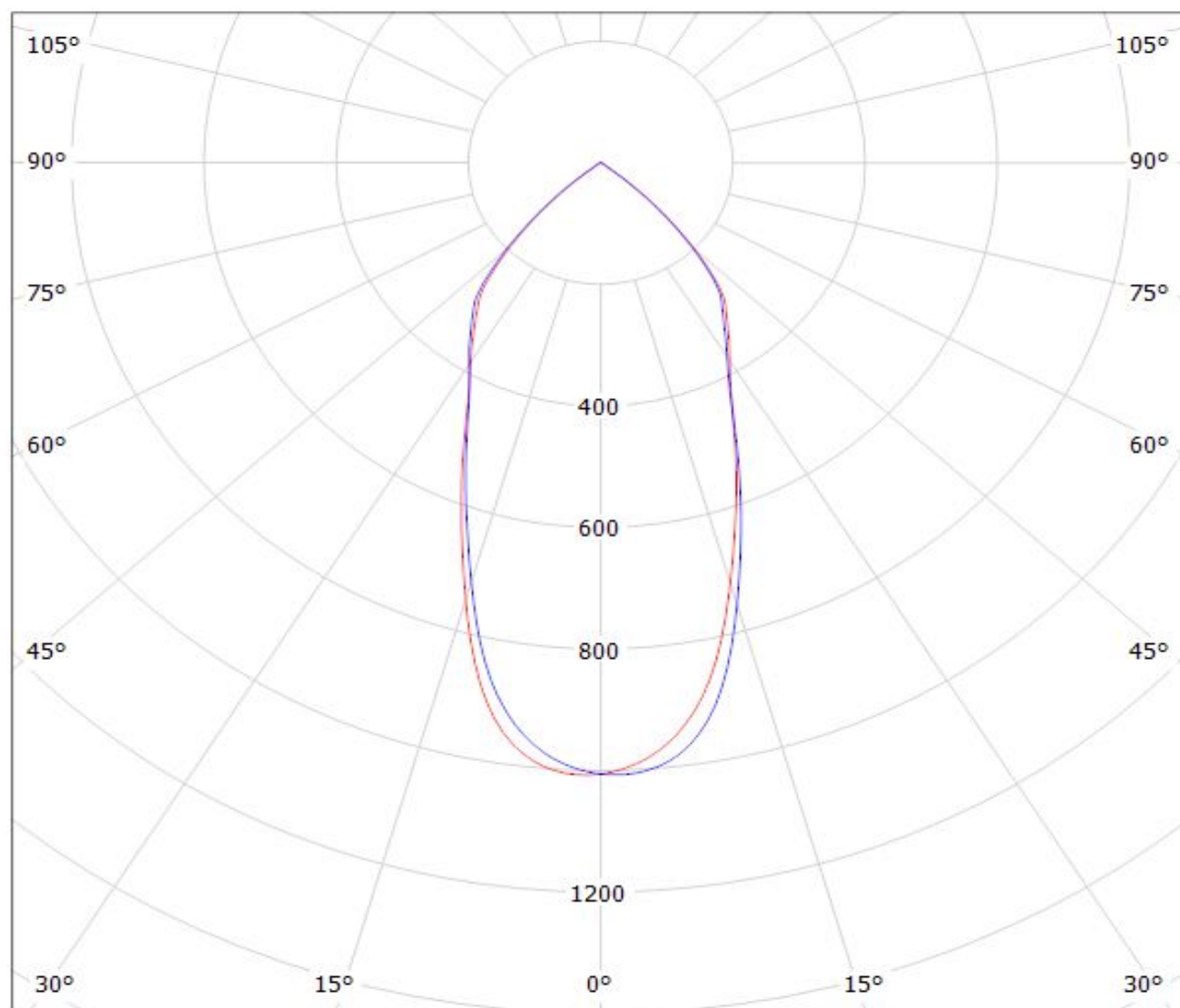

cd/klm

— C0 - C180 — C90 - C270

$\eta = 92\%$

Luminaire: LEDil Oy F13660\_ANGELINA-M-B\_(CXM-14)

Lamps: 1 x Luminus CXM-14 (1078.95lm @ 250mA) CCT=3100K P=8.5W I=250mA

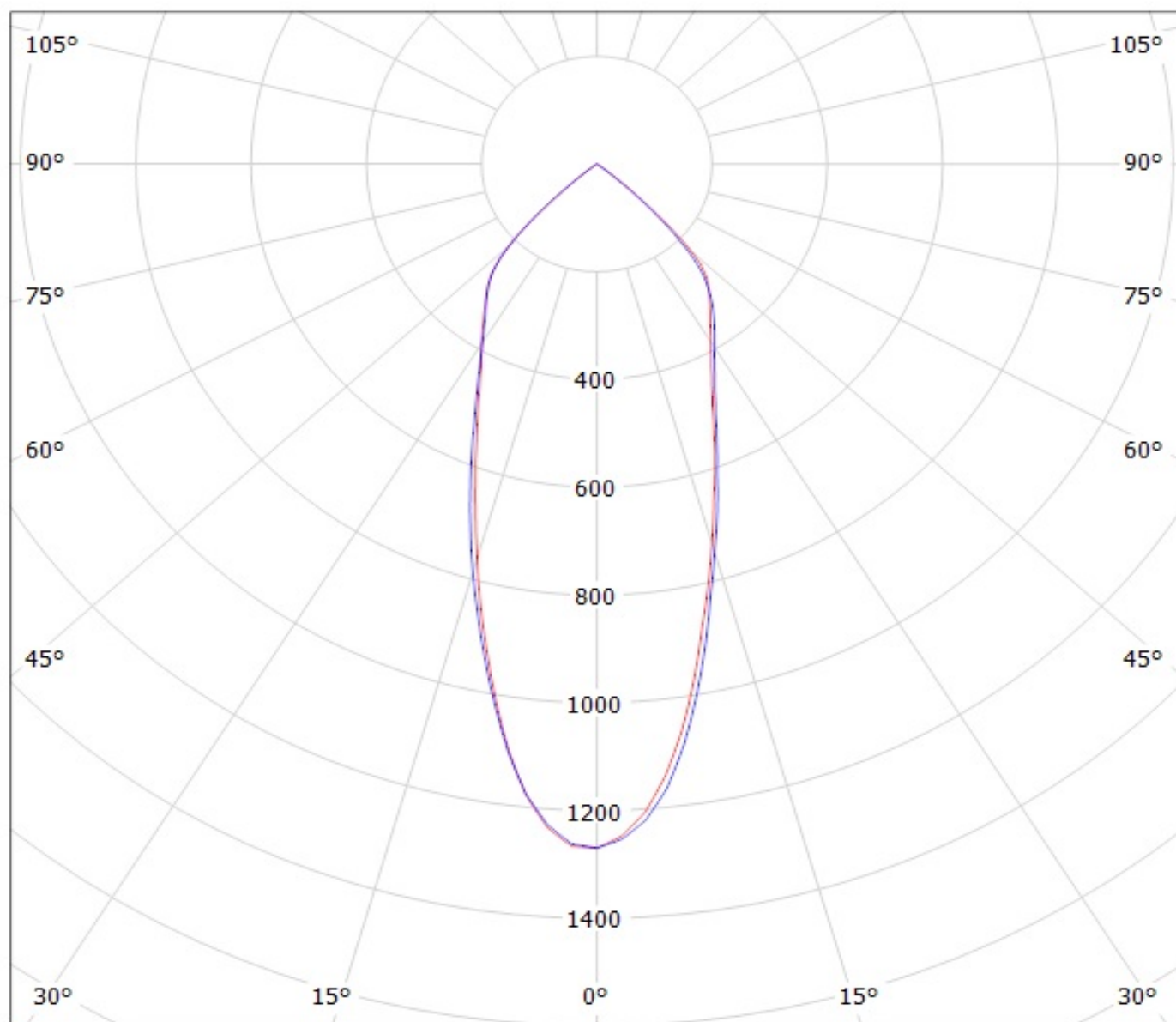

cd/klm

— C0 - C180

— C90 - C270

$\eta = 94\%$



Luminaire: LEDiL Oy C13660\_ANGELINA-M-B\_(Soleriq-E30) Eff: 90 %

Lamps: 1 x Osram Soleriq E30 (QW KAJRB2.EM-TPTR-50H4) 1358.6lm@250mA\_P=10.2338W\_I=0.2498mA

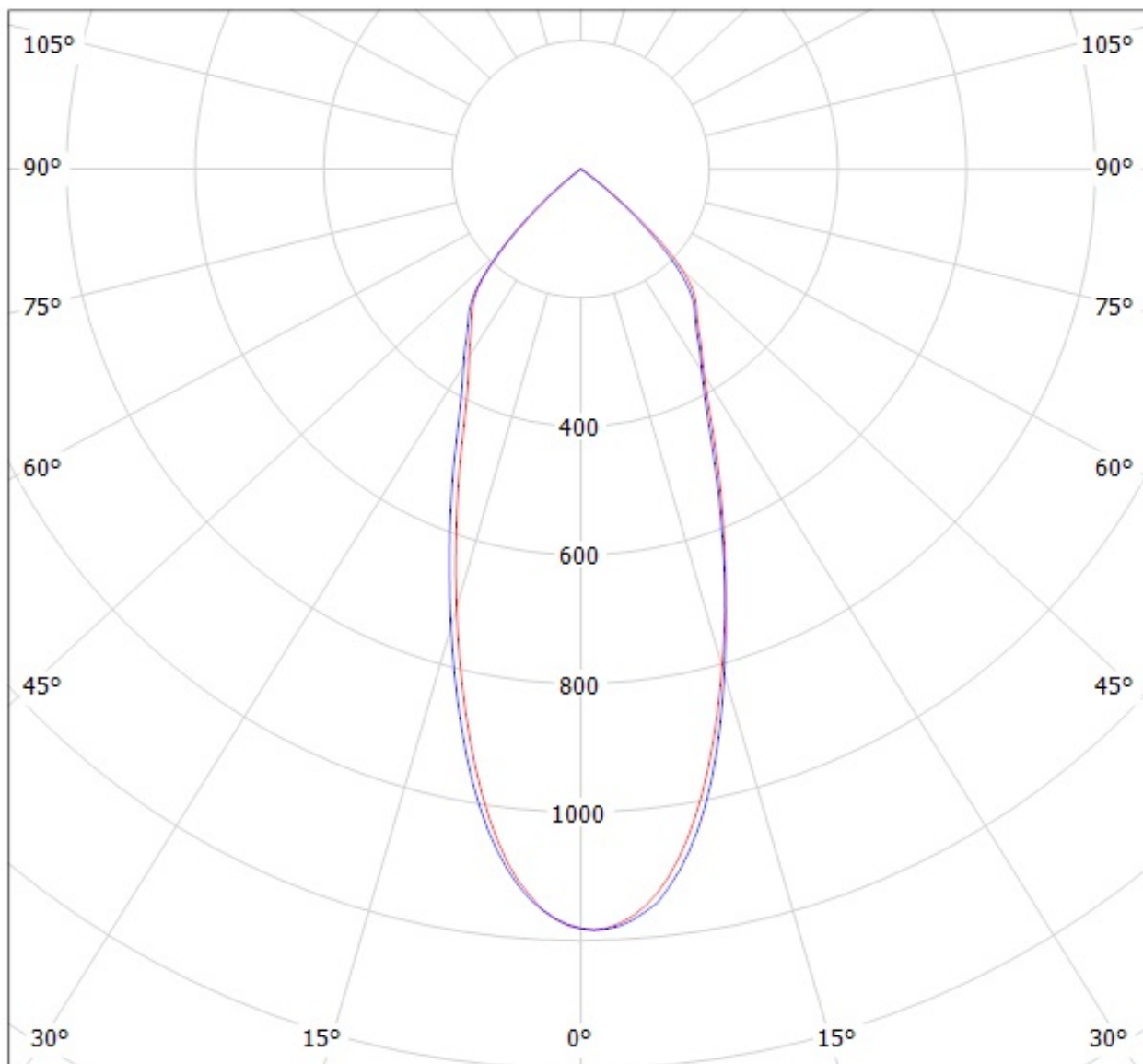

cd/klm

— C0 - C180

— C90 - C270

Luminaire: LEDiL Oy F13660\_ANGELINA-M-B\_(Soleriq\_S13) Eff.94.0%

Lamps: 1 x Osram\_Soleriq\_S13\_825.418lm@250mA\_CCT=3125K\_P=7.33663W\_I=249.8mA

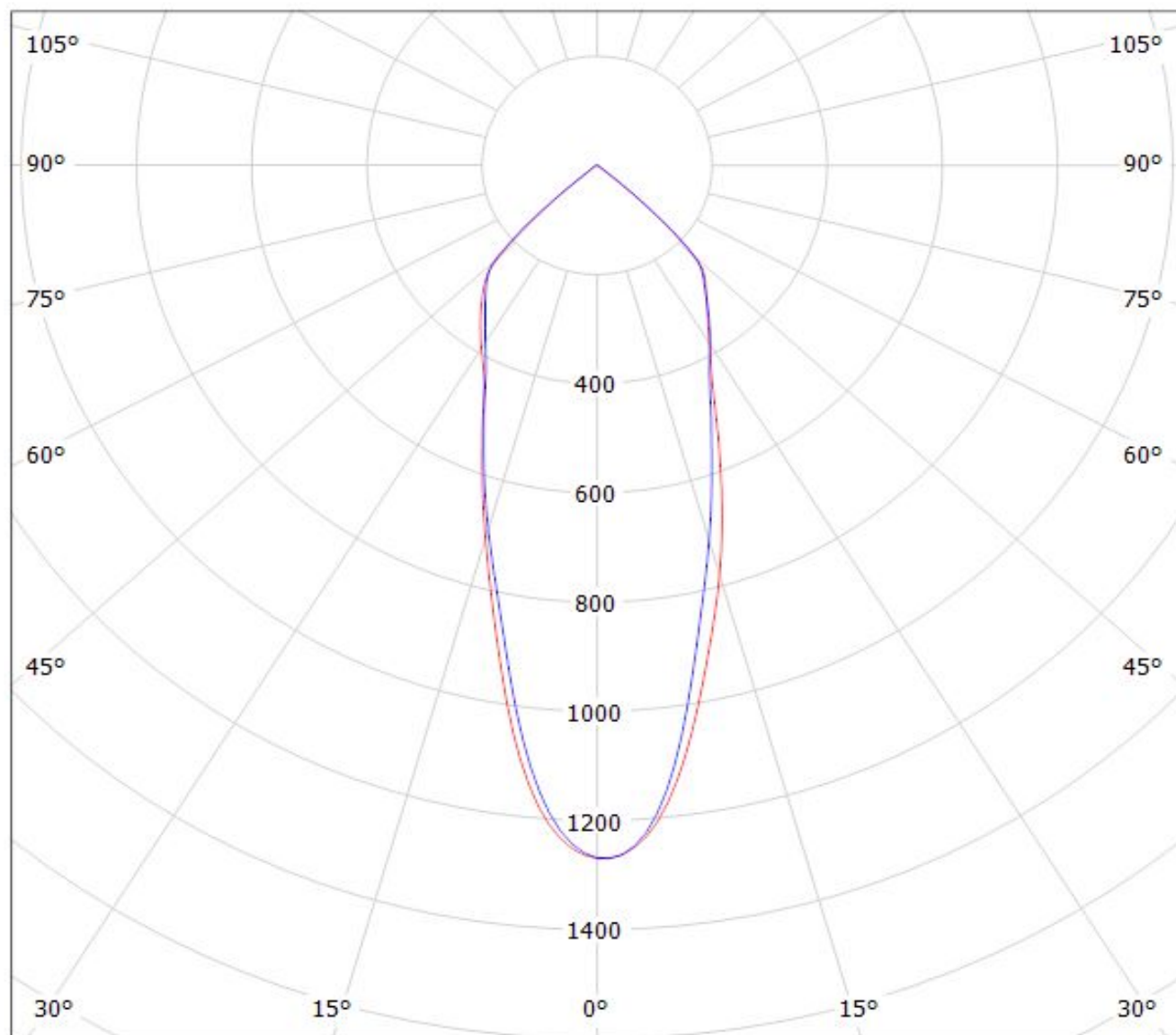

cd/klm

— C0 - C180

— C90 - C270

$\eta = 95\%$



Luminaire: LEDiL Oy F13660\_ANGELINA-M-B\_(Soleriq S19) Eff.93.8%  
Lamps: 1 x OSRAM\_SOLERIQ\_S19\_(GW\_KAHJB1.EM)  
\_1445.44lm@250mA\_CCT=3000K\_P=10.558W\_I=249.8mA

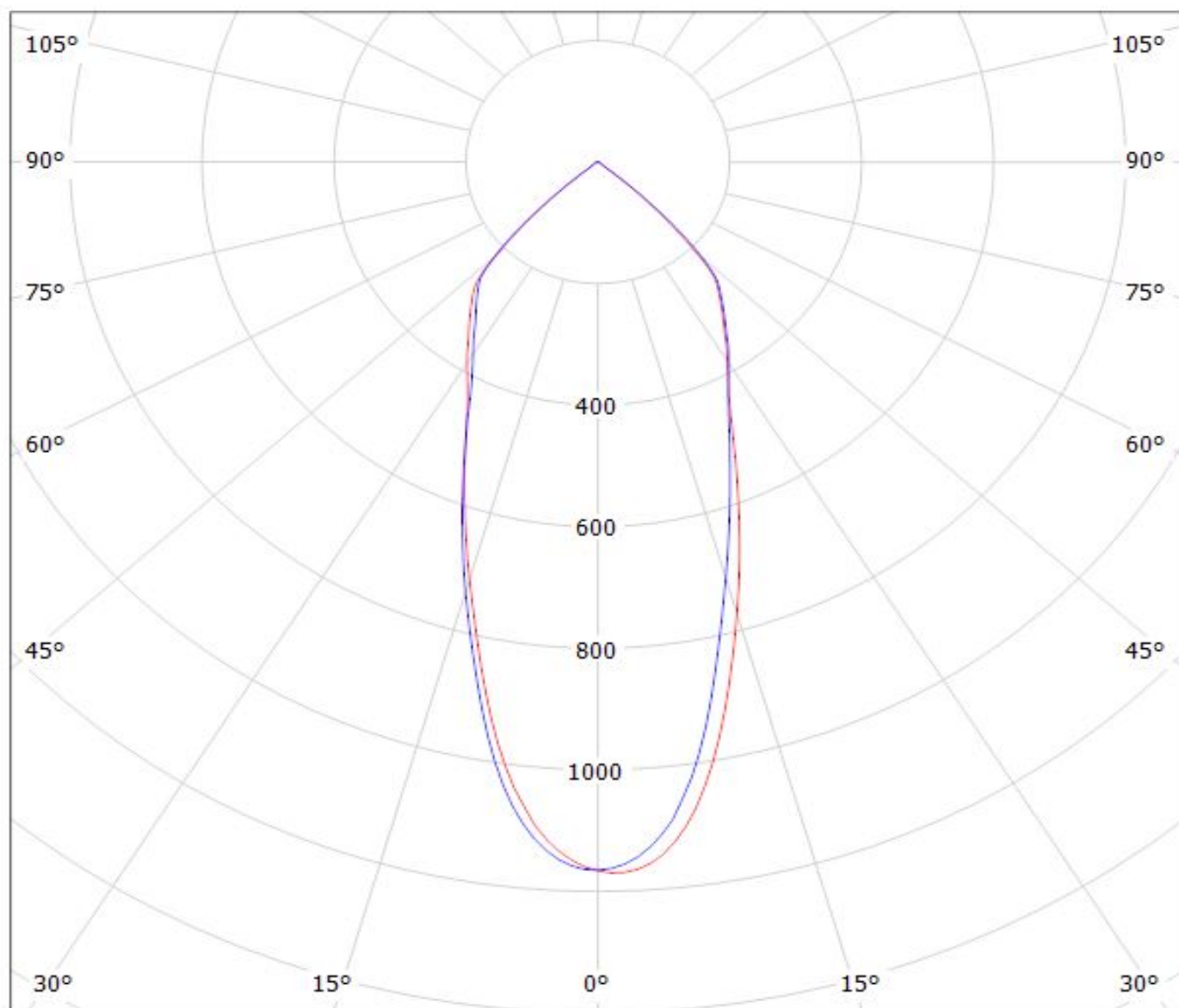

cd/klm

— C0 - C180

— C90 - C270

$\eta = 94\%$

Luminaire: LEDiL Oy F13660\_ANGELINA-M-B\_(S19) Eff.93.3%

Lamps: 1 x Osram\_SOLERIQ\_S19\_1434.85lm@250mA\_P=10.5595W\_I=249.8mA

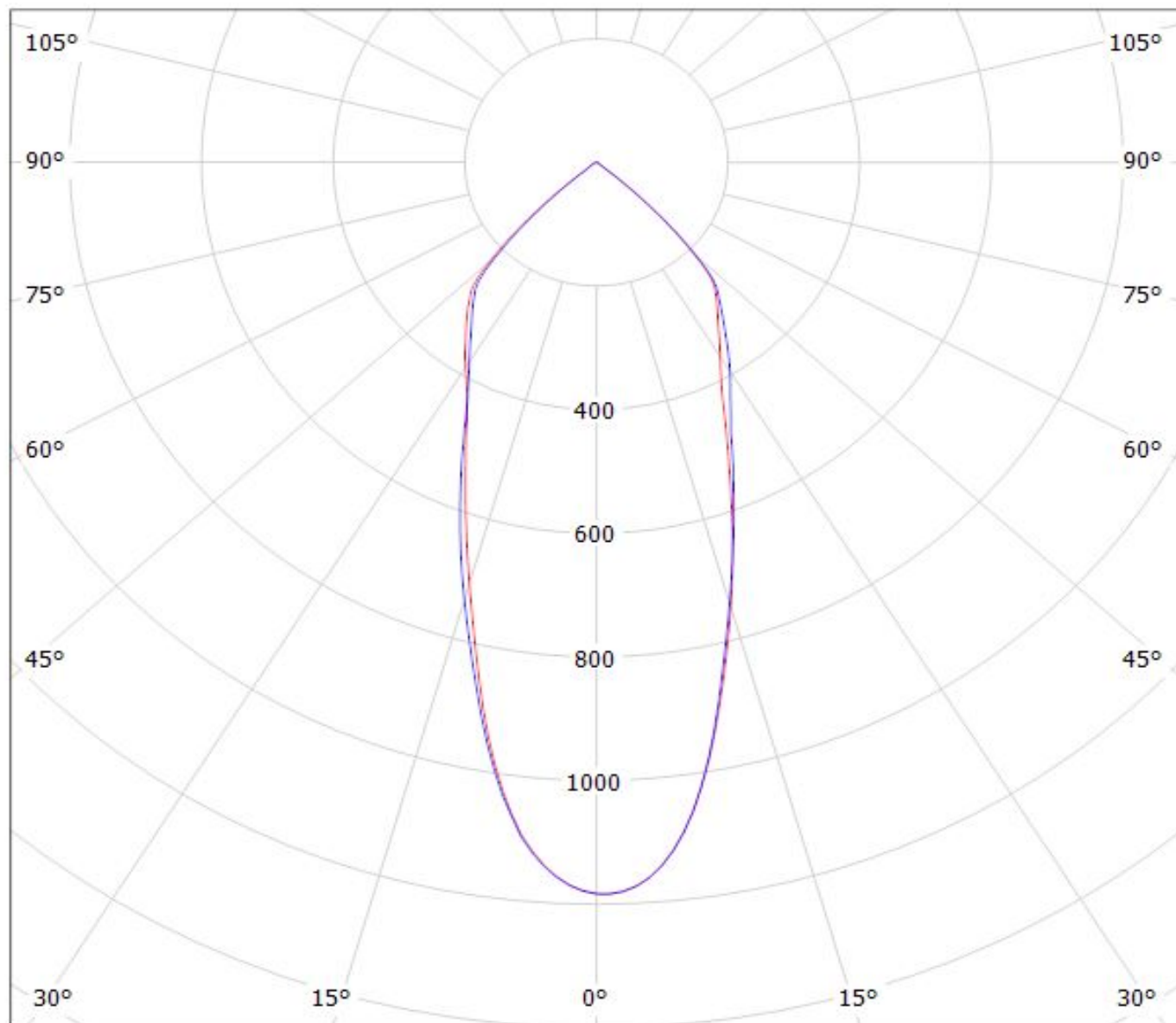

cd/klm

— C0 - C180

— C90 - C270

$\eta = 93\%$

Luminaire: LEDiL Oy F13660\_ANGELINA-M-B\_(SOLERIQ\_P13)

Lamps: 1 x SOLERIQ\_P13\_(GW\_MAGMB1.EM)\_1053.65lm@250mA\_CCT=3000K\_P=8.82044W\_I=249.8mA

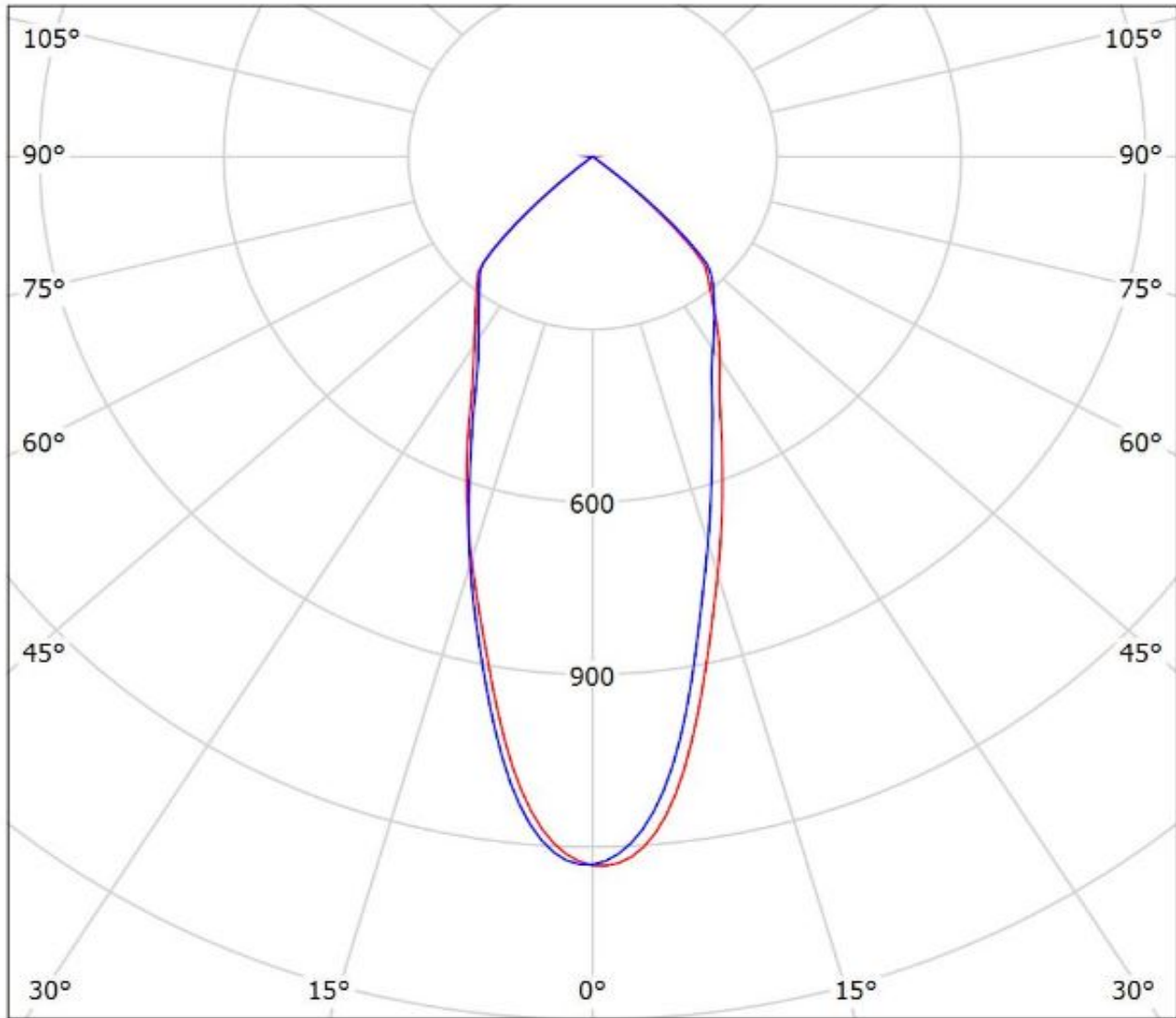

cd/klm

— C0 - C180

— C90 - C270

$\eta = 94\%$

Luminaire: Ledil F13660\_ANGELINA-M-B\_(Soleriq\_S13\_G2)

Lamps: 1 x Osram\_Soleriq\_S13\_G2\_(GW\_KAGHB2.EM)1353.18lm@250m\_P=8.46W\_I=0.25A

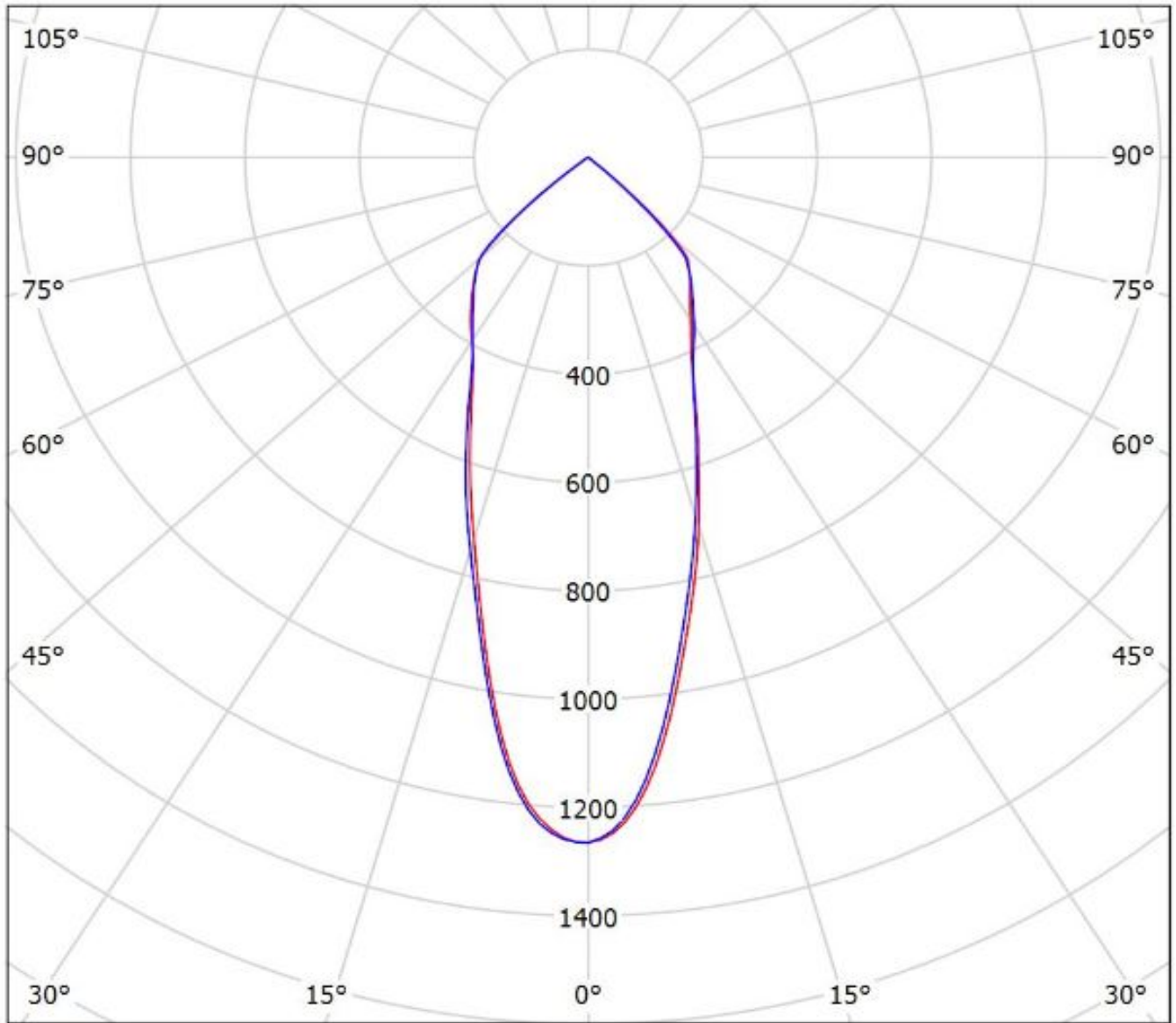

cd/klm

— C0 - C180

— C90 - C270

$\eta = 93\%$

Luminaire: Ledil Oy F13660\_ANGELINA-M-B+\_BJB\_47.319.2030\_SAMSUNG\_COB\_D\_LC040D\_SIMULAT  
Lamps: 1 x SAMSUNG LC040D

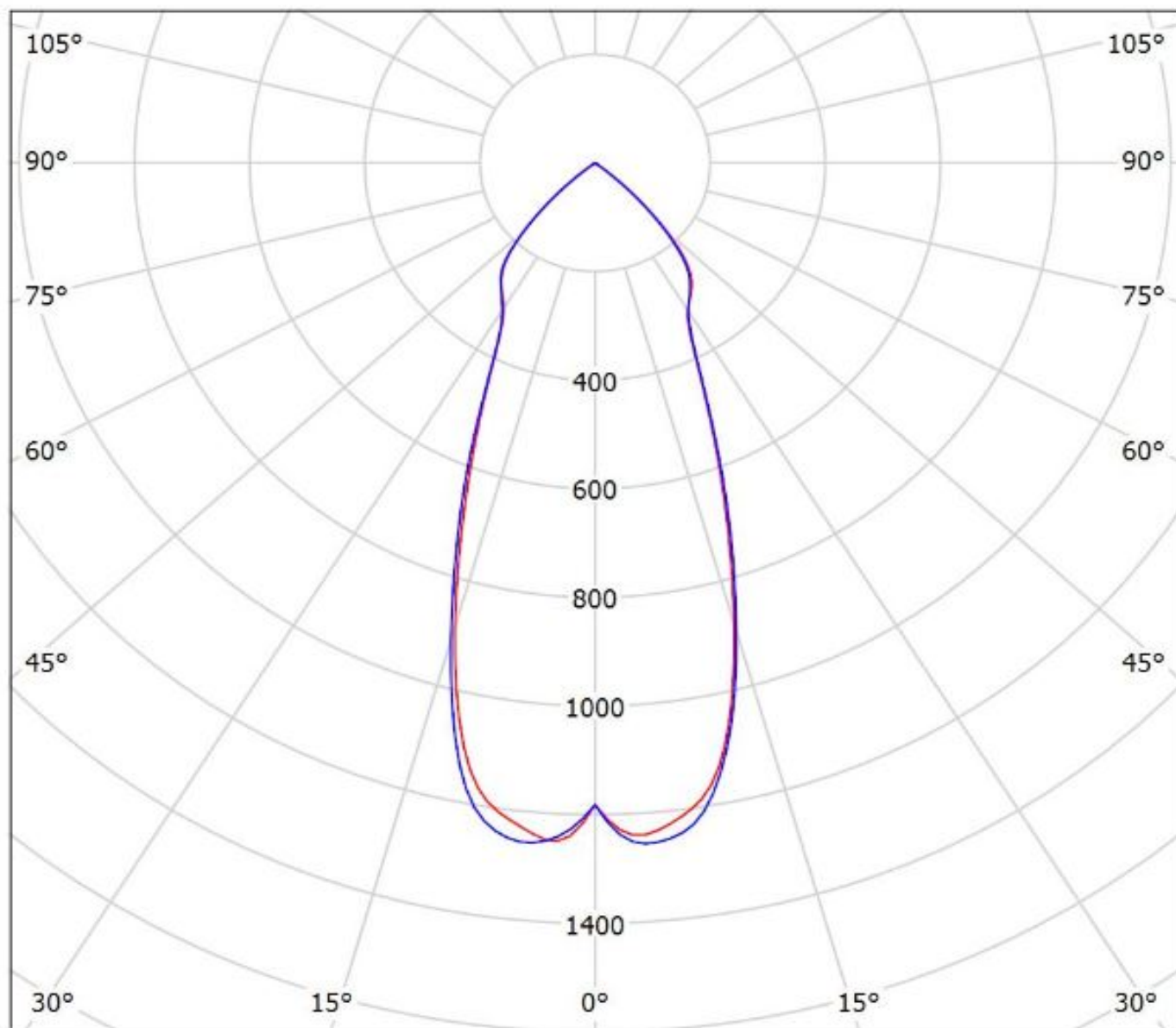

cd/klm

— C0 - C180 — C90 - C270

$\eta = 90\%$

Luminaire: LEDiL Oy F13660\_ANGELINA-M-B\_(COB\_D\_14,5mm)

Lamps: 1 x Samsung\_COB\_D\_Series-LES-14,5\_LC026D\_1296.34lm@250mA\_CCT=3000K\_P=8.1225W\_I=0.250A

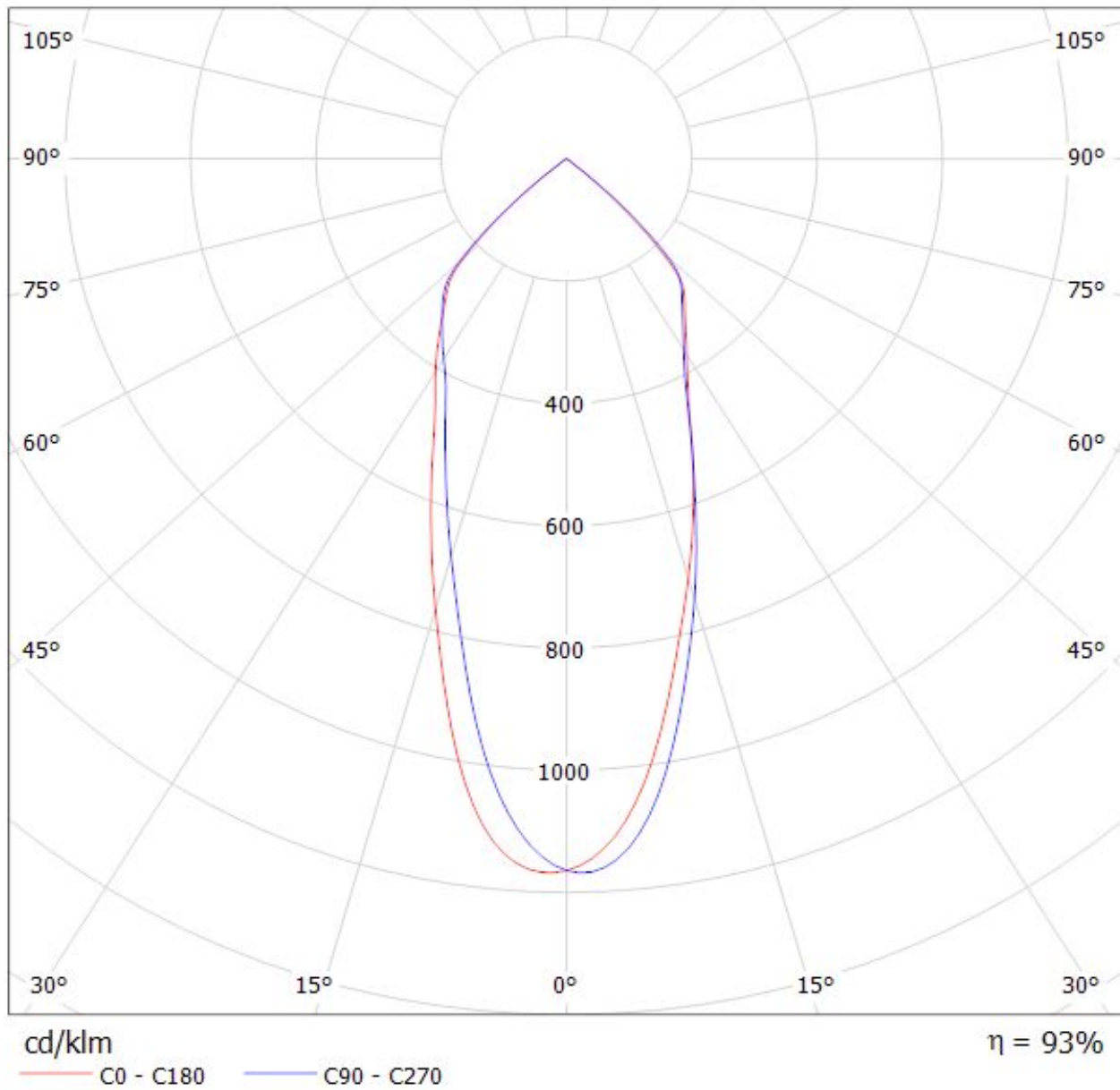



Luminaire: LEDiL Oy F13660\_ANGELINA-M-B\_(COB\_D\_14,5mm)

Lamps: 1 x Samsung\_COB\_D\_Series-LES-14,5\_LC026D\_1296.34lm@250mA\_CCT=3000K\_P=8.1225W\_I=0.250A

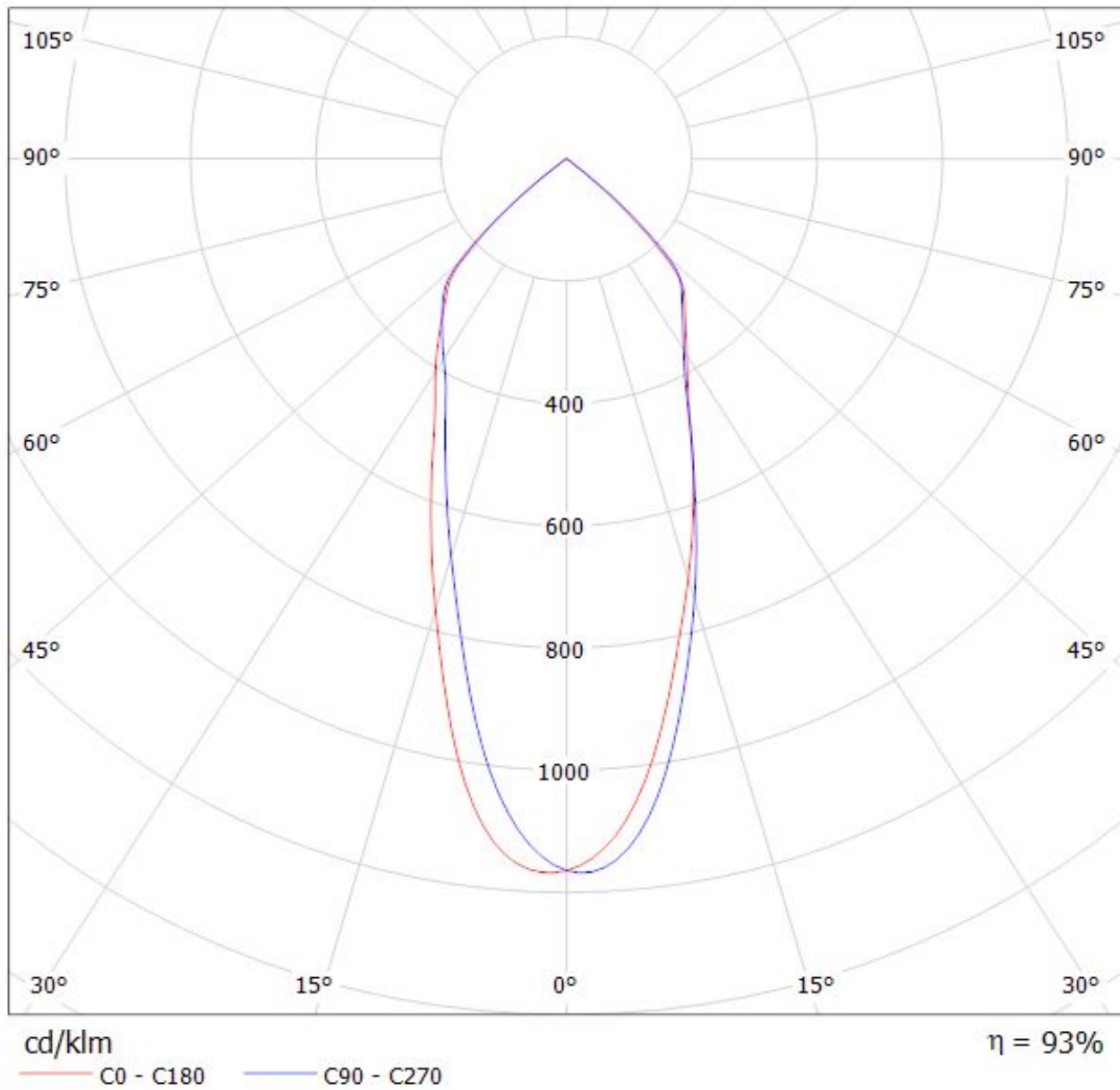

Luminaire: LEDiL Oy F13660\_ANGELINA-M-B\_(ZC12)

Lamps: 1 x SEOUL\_ZC12\_(SDW82F1C)\_1240.73lm@250mA\_P=8.68405W\_I=249.8mA

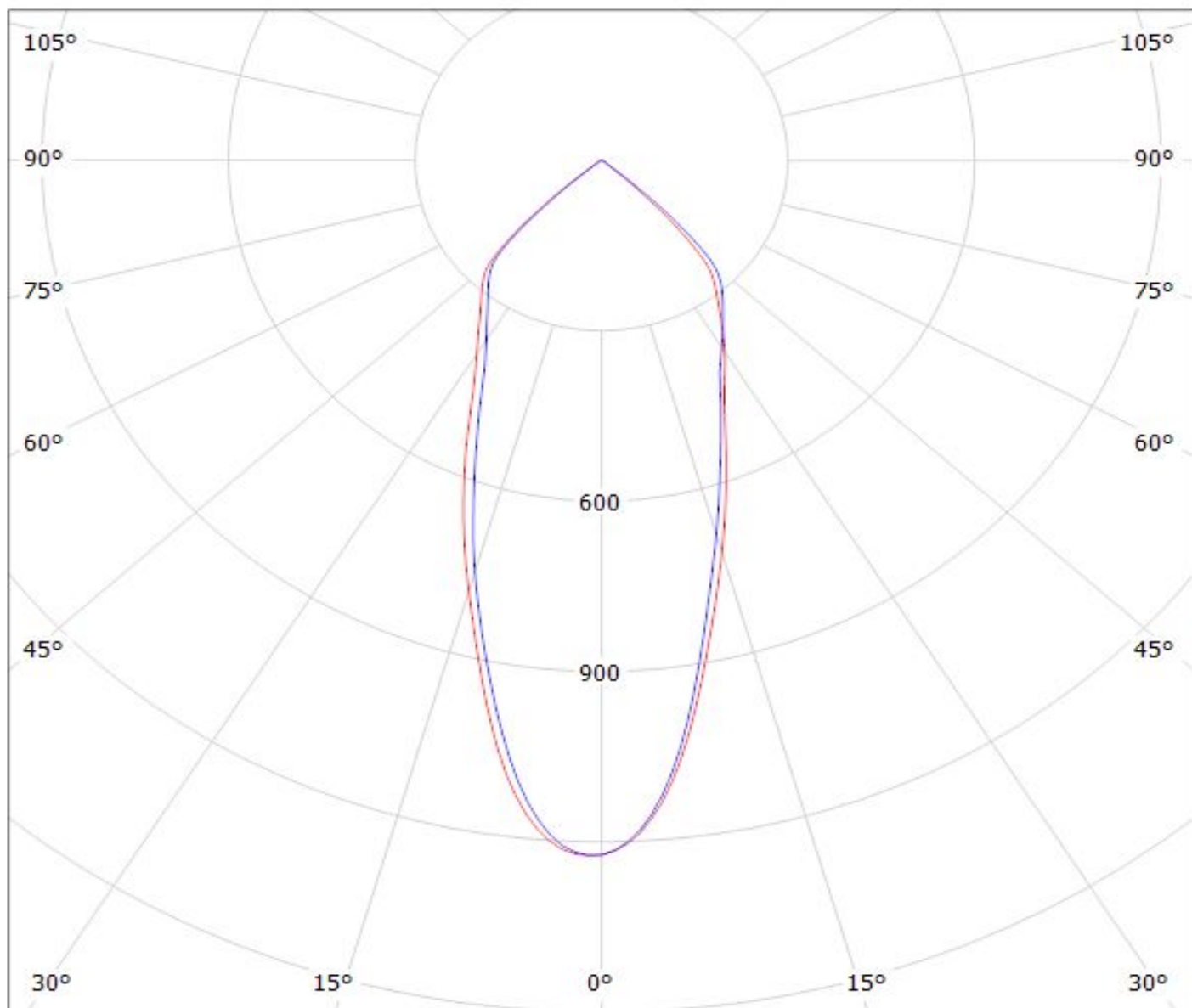

cd/klm

— C0 - C180    — C90 - C270

$\eta = 93\%$



Luminaire: LEDiL Oy F13660\_ANGELINA-M-B\_(ZC40)

Lamps: 1 x SEOUL\_ZC40\_(SBWW5F1B)\_1185.55lm@250mA\_P=8.2384W\_I=249.8mA

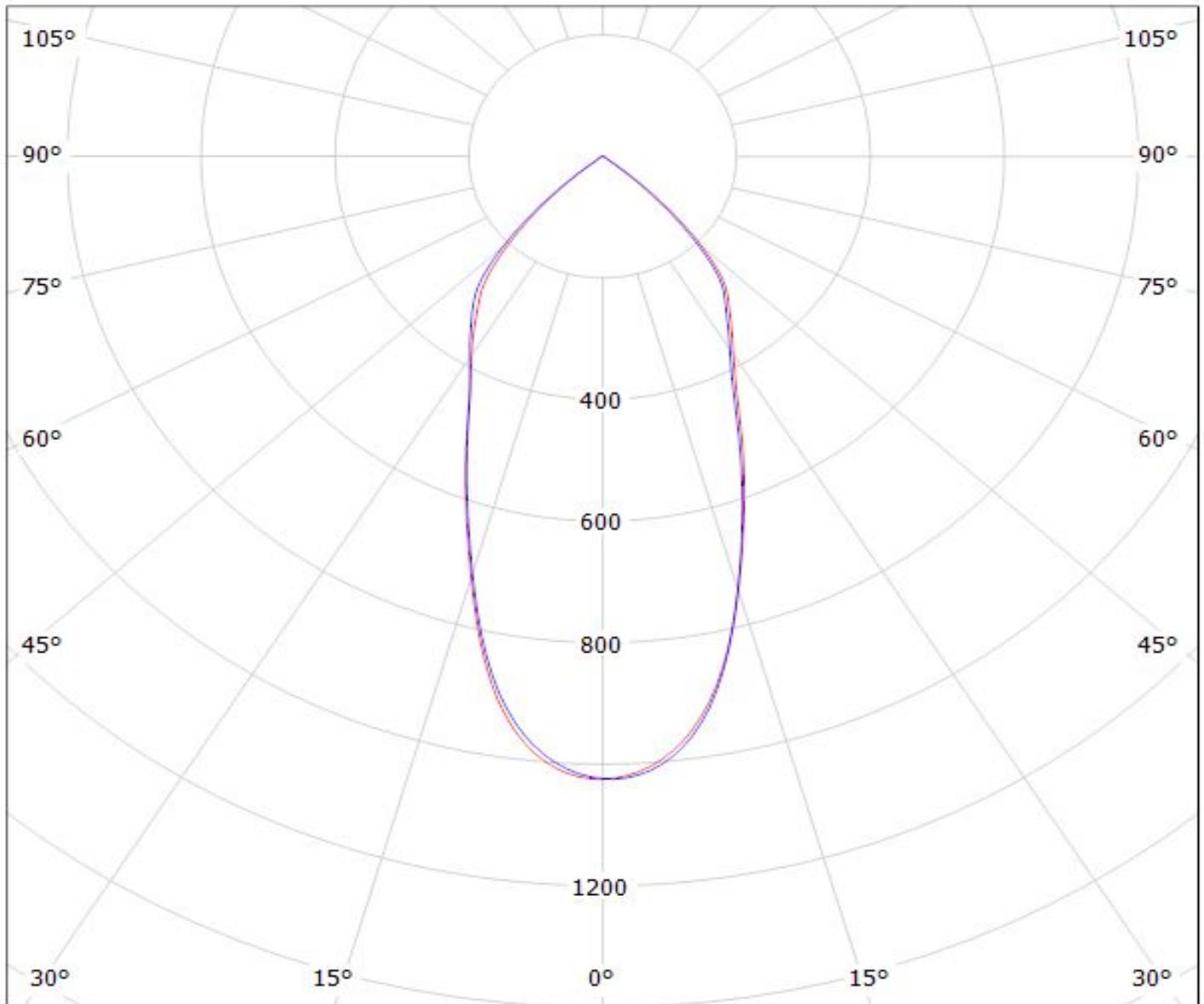

cd/klm

$\eta = 92\%$

— C0 - C180

— C90 - C270

Luminaire: LEDiL Oy F13660\_ANGELINA-M-B\_(MegaZenigata\_GW6)  
Lamps: 1 x Sharp\_MegaZenigata\_GW6\_(GW6DME30NFC)  
\_1266.19lm@250mA\_CCT=3038K\_P=11.2151W\_I=250.6mA

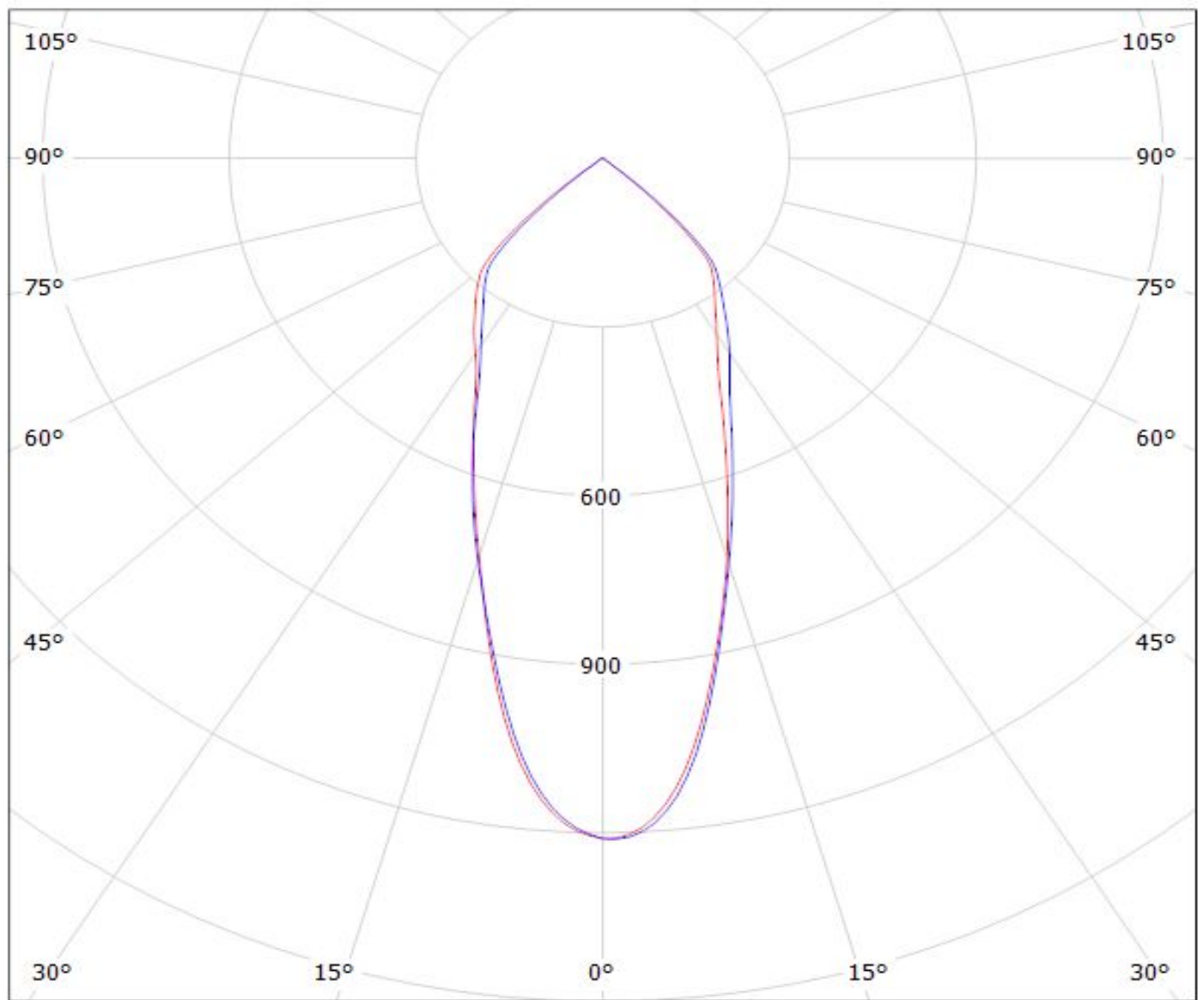

cd/klm

— C0 - C180 — C90 - C270

$\eta = 95\%$

Luminaire: LEDiL Oy F13660\_ANGELINA-M-B\_(STARK\_SLE\_G3\_LES17)  
Lamps: 1 x TRIDONIC\_STARK\_SLE\_G3\_LES17\_(STARK-SLE-PURE\_G3-17-2000-840-CLA)  
\_1030.26lm@250mA\_CCT=2000K\_P=8.34707W\_I=249.8mA

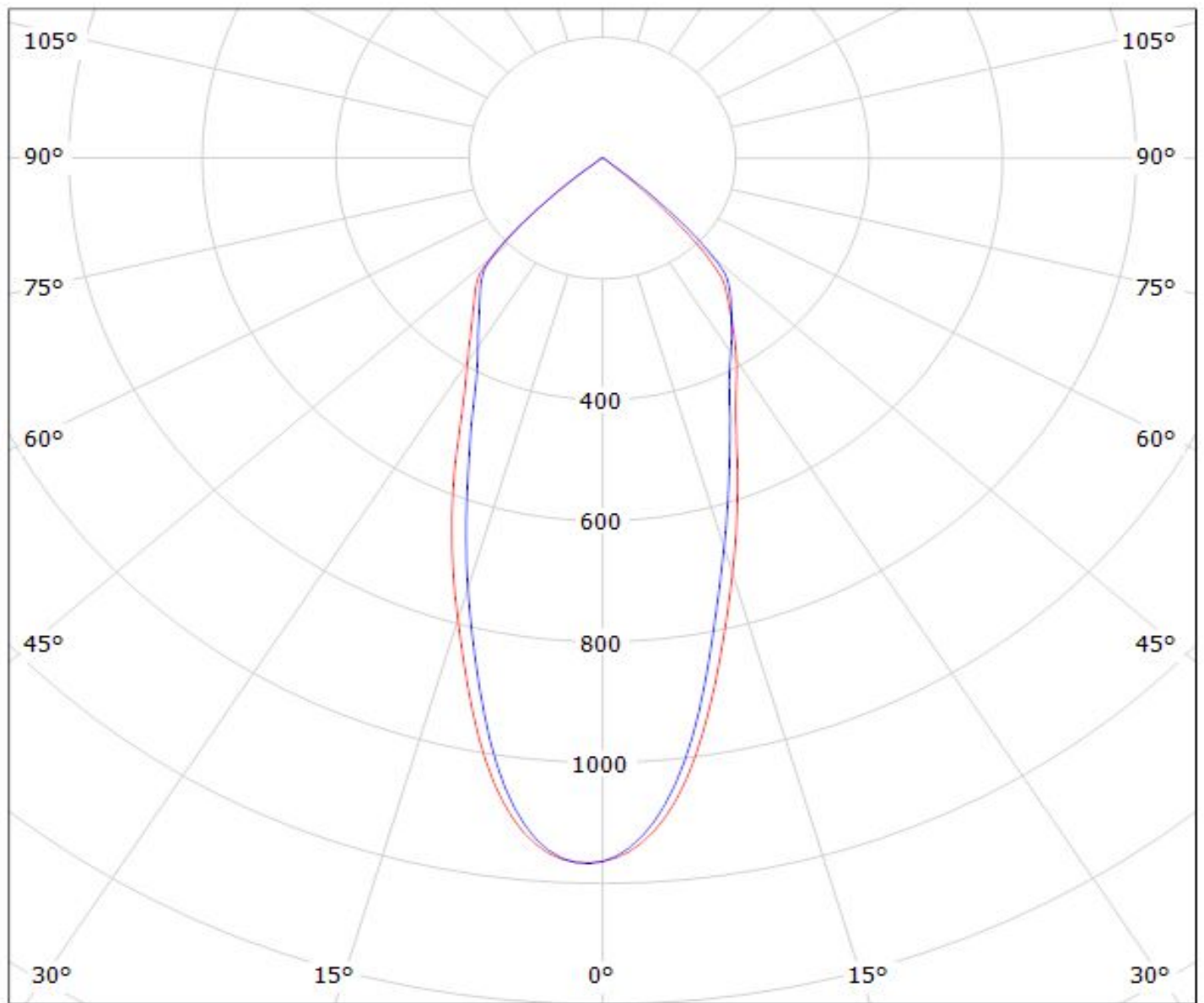

cd/klm

— C0 - C180 — C90 - C270

$\eta = 93\%$

Luminaire: LEDiL Oy F13660\_ANGELINA-M-B\_(SLE G4 LES23)  
Lamps: 1 x Tridonic\_SLE\_G4\_LES23\_1428.75lm@250mA\_P=8.19944W\_I=0.2498A

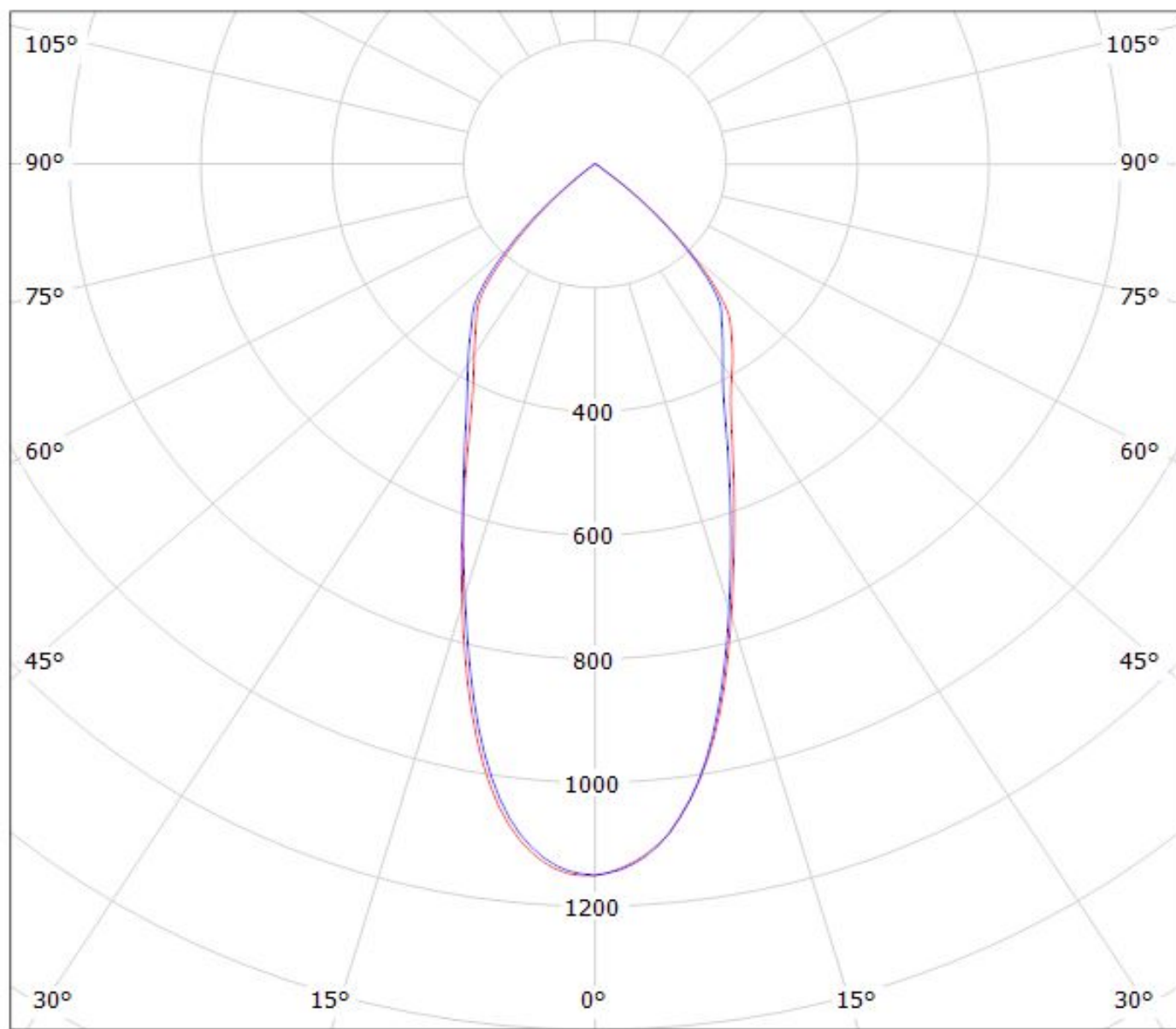

cd/klm η = 92%  
— C0 - C180 — C90 - C270

Luminaire: LEDiL Oy F13660\_ANGELINA-M-B\_(SLE GEN4 LES19)

Lamps: 1 x SLE GEN4 LES19\_1226.28lm@250mA\_P=8.21367W\_I=0.2498A

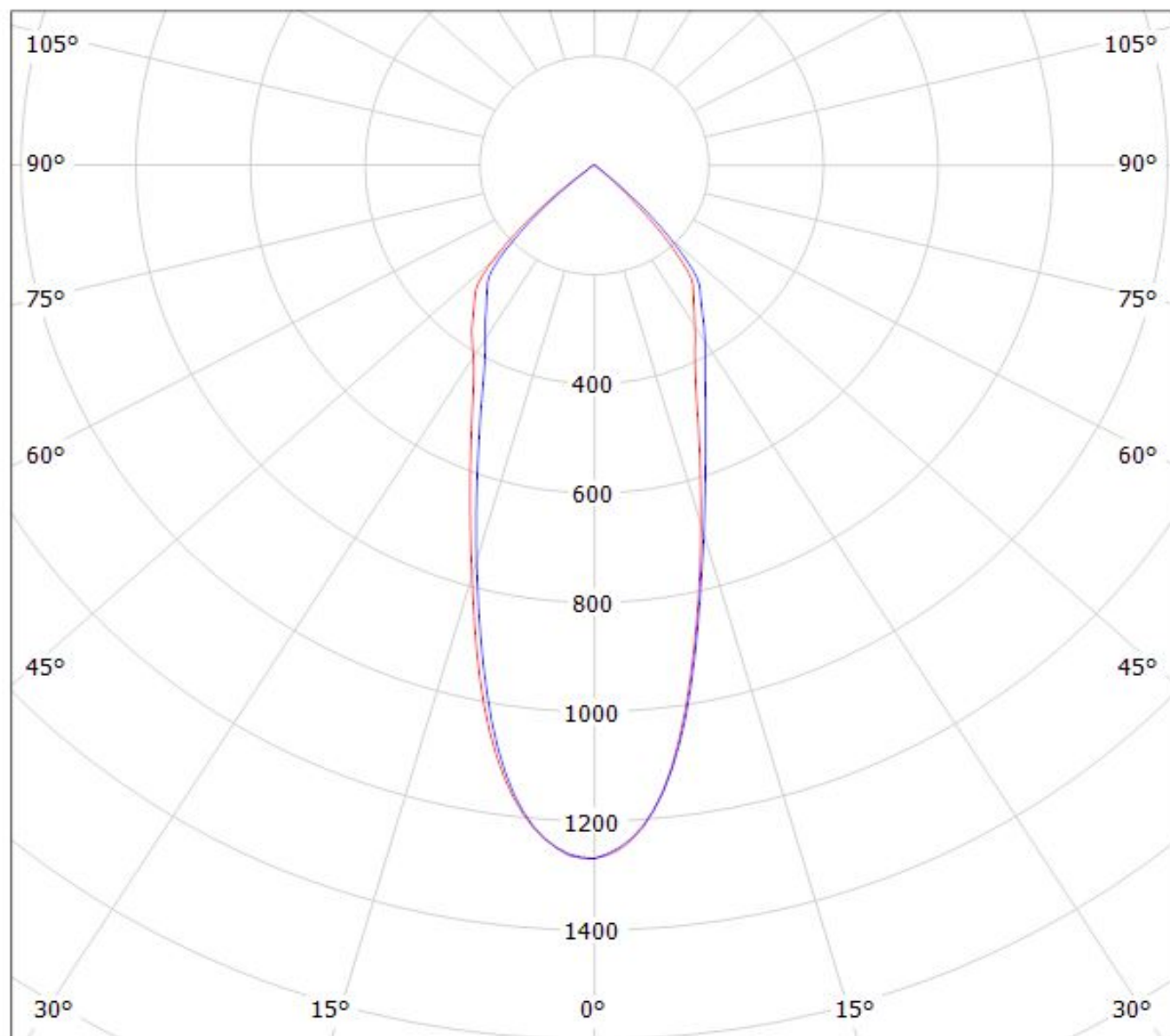

cd/klm

— C0 - C180

— C90 - C270

$\eta = 91\%$

Luminaire: LEDiL Oy F13660\_ANGELINA-M-B\_(SLE-G5\_LES-15)

Lamps: 1 x Tridonic\_SLE-G5\_LES-15\_1272.36lm@250mA\_P=8.6660W\_I=0.250A

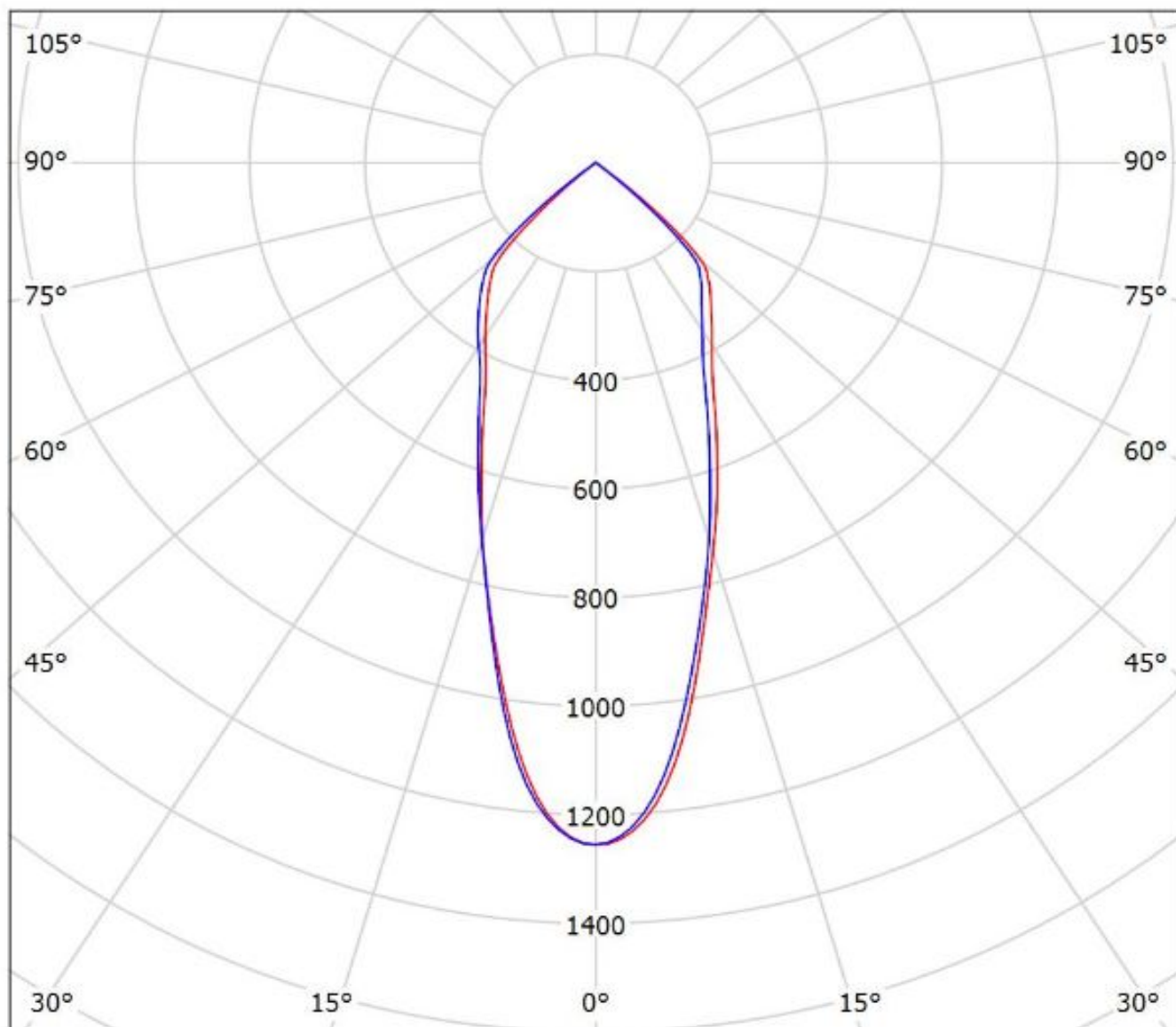

cd/klm

— C0 - C180

— C90 - C270

$\eta = 94\%$



Luminaire: LEDiL Oy F13660\_ANGELINA-M-B\_(SLE-G5\_LES-19)

Lamps: 1 x Tridonic\_SLE-G5\_LES-19\_1334.47lm@250mA\_P=8.2224W\_I=0.250A

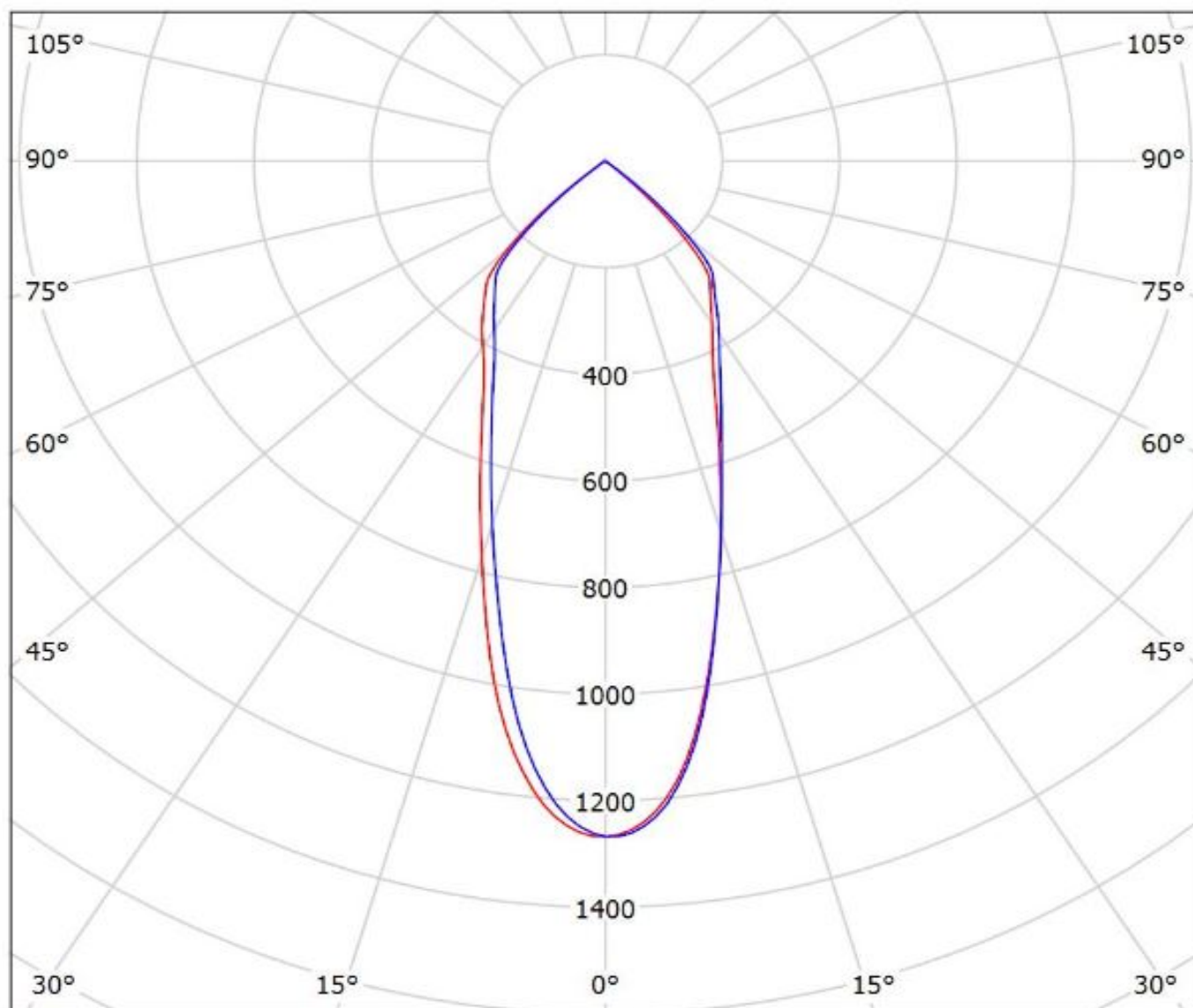

cd/klm

— C0 - C180 — C90 - C270

$\eta = 91\%$



Luminaire: LEDiL Oy F13660\_ANGELINA-M-B\_(SLE-G5\_LES-23)  
Lamps: 1 x Tridonic\_SLE-G5\_LES-23\_1371.74lm@250mA\_P=8.1065W\_I=0.250A

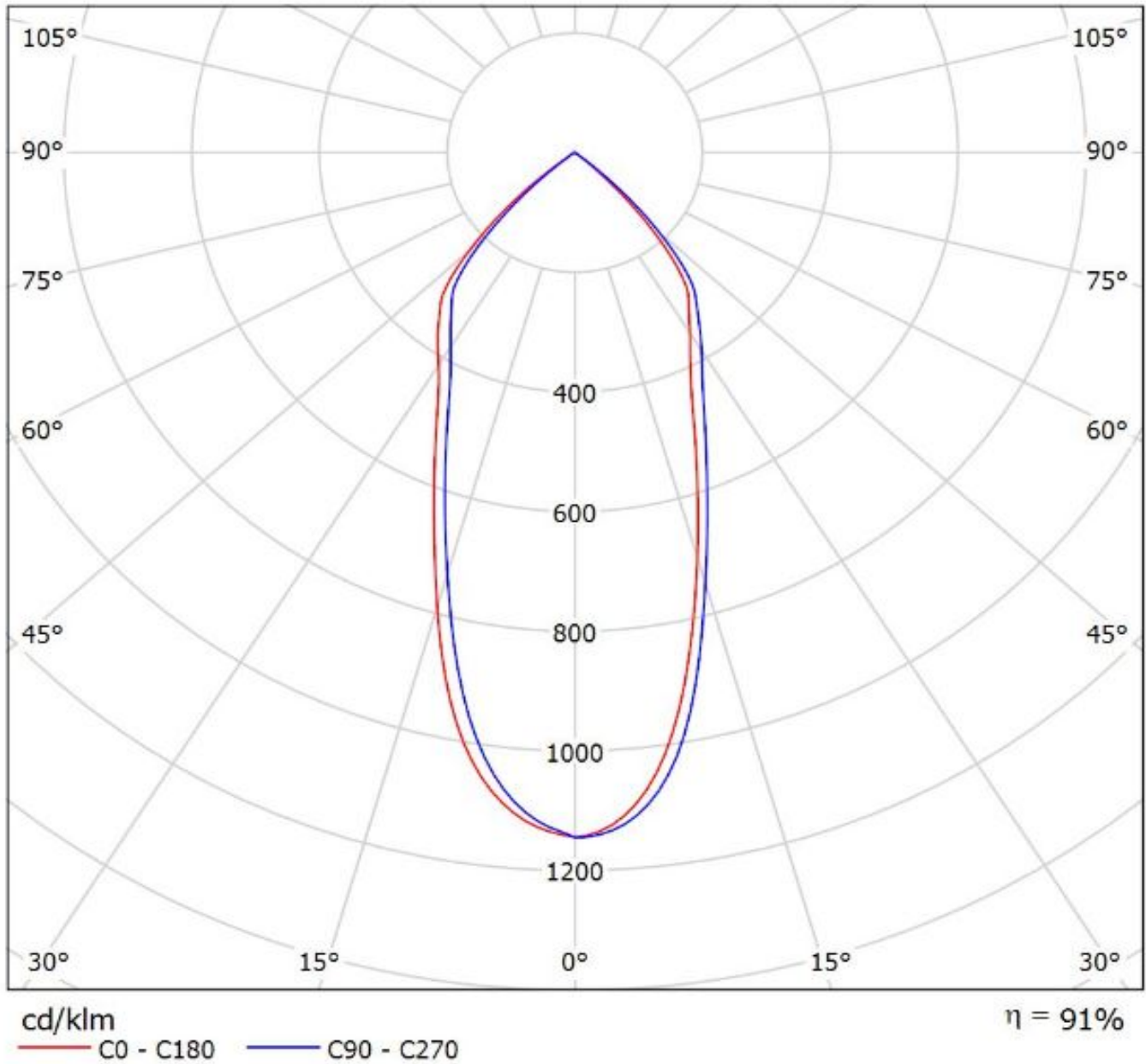

Luminaire: Ledil Oy F13660\_ANGELINA-M-B\_TRIDONIC\_SLE\_G6\_LES19\_H\_SIMULATED  
Lamps: 1 x TRIDONIC SLE G6 LES19 H

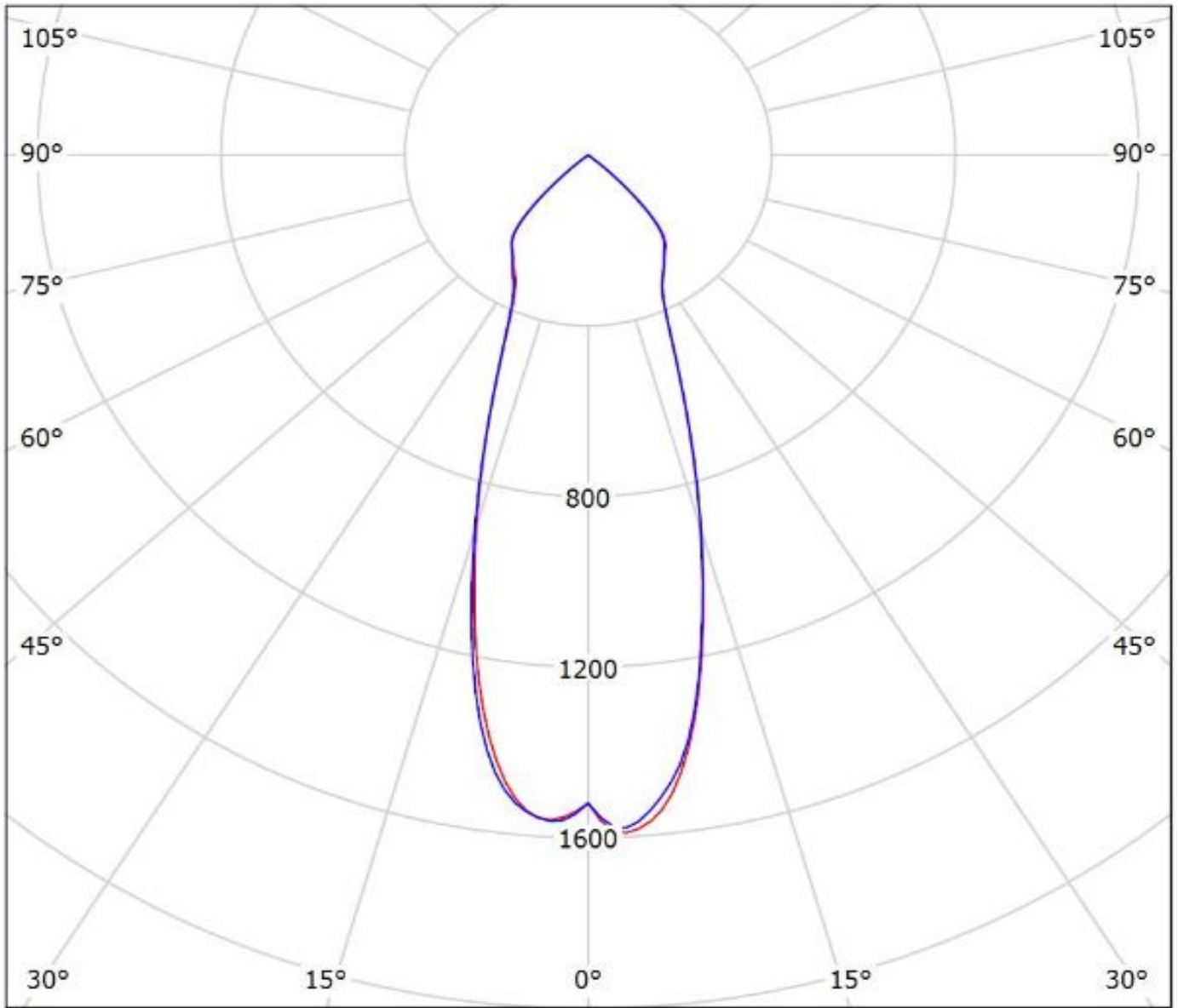

cd/klm

— C0 - C180 — C90 - C270

$\eta = 91\%$

Luminaire: Ledil Oy F13660\_ANGELINA-M-B\_TRIDONIC\_SLE\_G6\_LES23\_H\_SIMULATED  
Lamps: 1 x TRIDONIC SLE G6 LES23 H

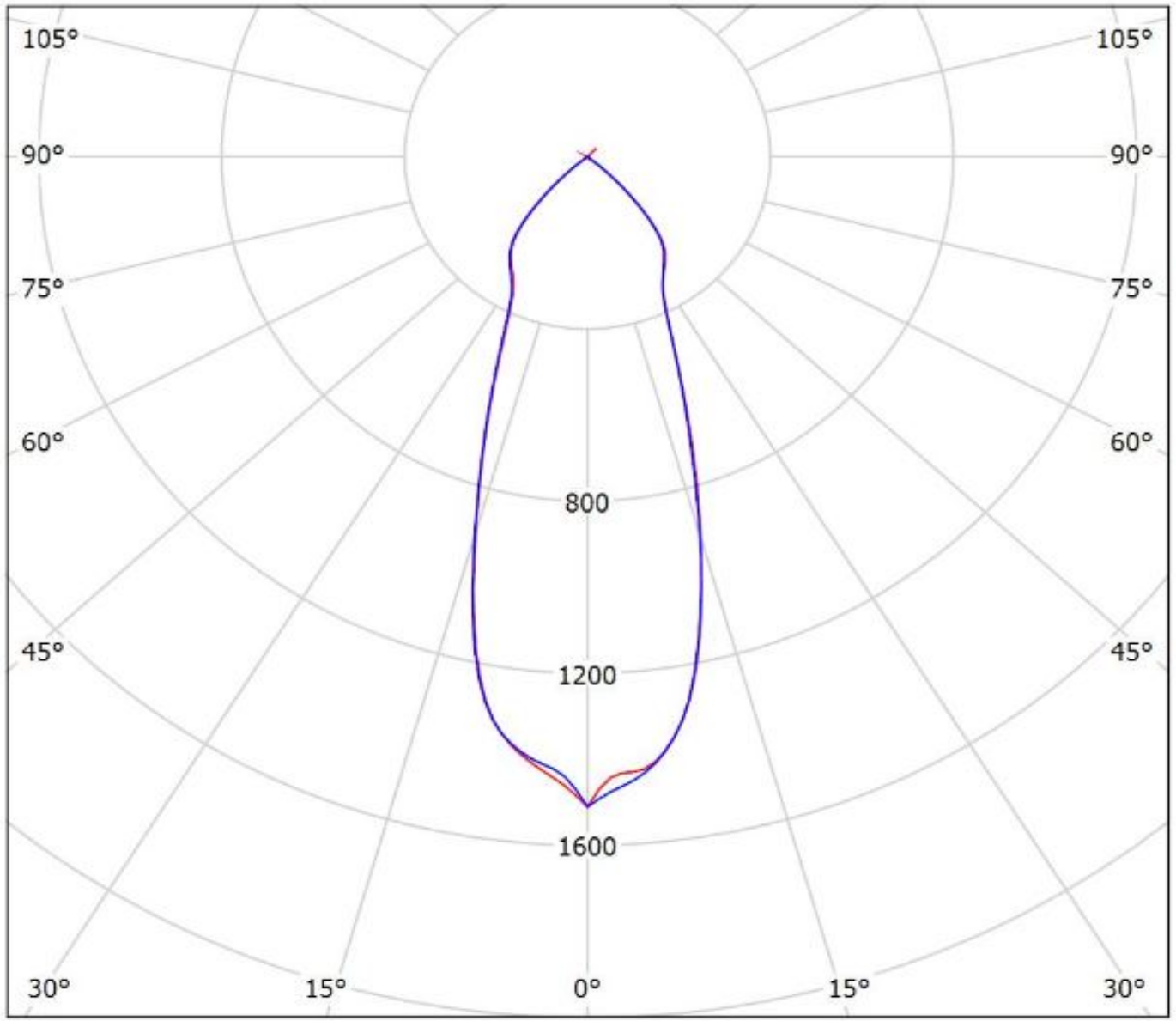

cd/klm

— C0 - C180 — C90 - C270

$\eta = 90\%$

Luminaire: Ledil Oy F13660\_ANGELINA-M-B\_(SLE\_G6\_LES17\_H)\_SIMULATED  
Lamps: 1 x Tridonic SLE G6 LES17 H

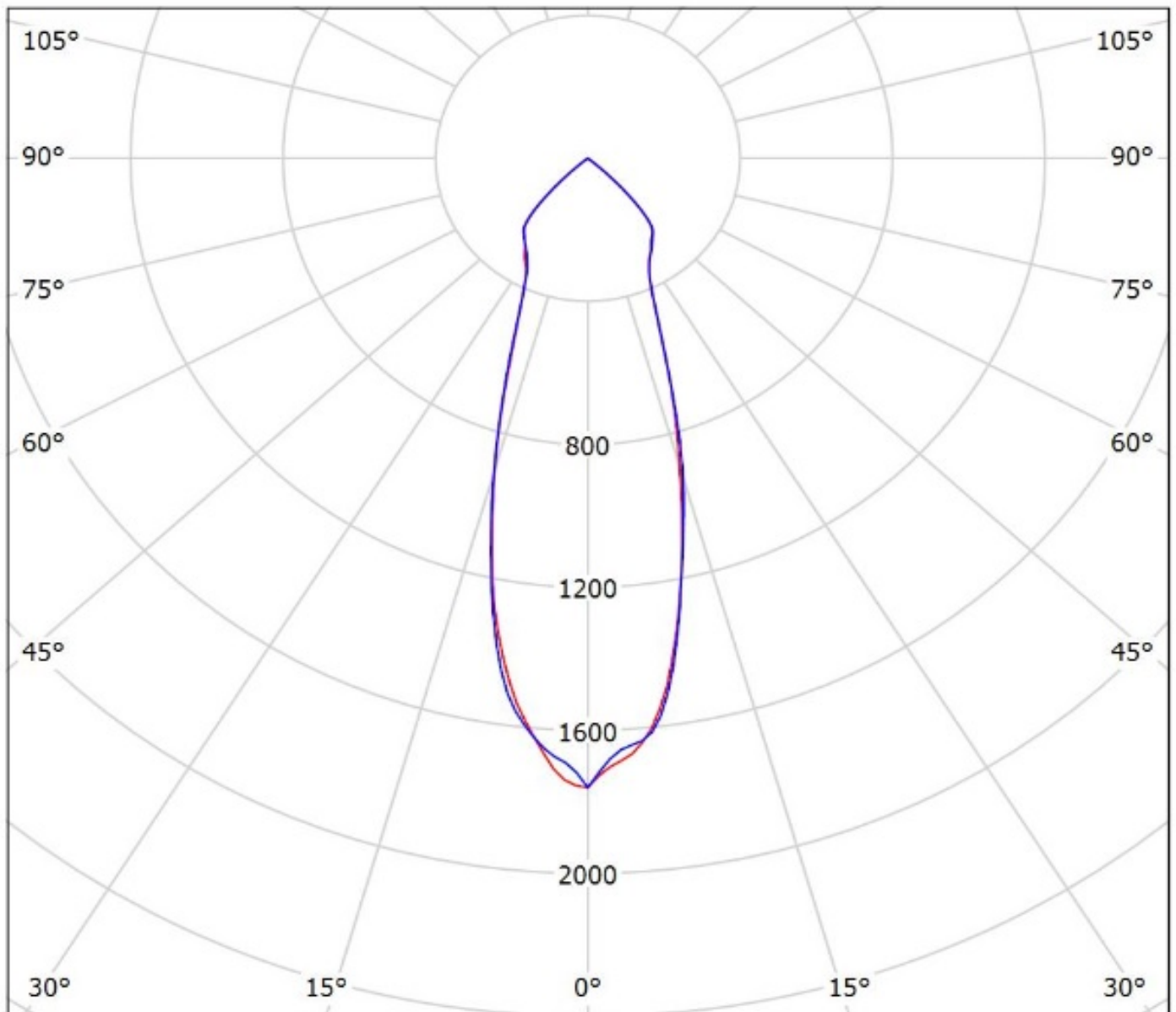

cd/klm

— C0 - C180 — C90 - C270

$\eta = 91\%$

**NOTE: The typical divergence will be changed by different color, chip size and chip position tolerance. The typical total divergence is the full angle measured where the luminous intensity is half of the peak value.**

### **GENERAL INFORMATION**

- Product series especially designed & optimized for series of LEDs.
- Special care taken to make light distribution as uniform as possible.

Note! Due to use of high power COB's with this product, special attention to proper thermal design is highly recommended. LEDiL has no liability for direct, indirect or consecutive damages arising from the LEDiL products being used outside of the recommended temperature range.