

## Data sheet

Commercial Art.No.: 25.342.3453.0

PCB connector 8213 BL / 4 G OB

PCB female connector with pin header, connection method depends on used socket part, 4 poles, pitch: 5.08 mm, type of packing: carton, color: grey

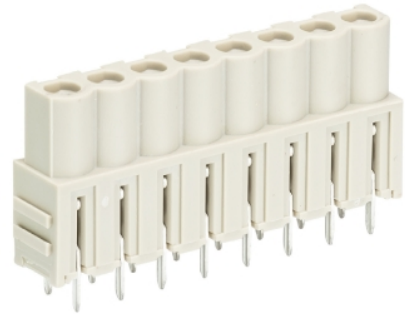

Commercial Art.No.	25.342.3453.0
EAN	4015573190580
Order Unit	50

Certificates / Approvals



## Technical data

### General

Modular spacing	5.08 mm
Connection type	Soldering connection
Soldering process	Wave soldering
Packaging	Carton
Number of poles	4
Marking	No
Fastening	None
Mating direction towards connector	None

### Technical data

Nominal cross section	2.5 mm <sup>2</sup>
Rated current	12 A
Overvoltage Category I	1000 V
Overvoltage Category II	690 V
Overvoltage Category III	250 V
Rated impulse voltage	4 kV

### Technical Data UL/CSA

Voltage UL	300 V
Current field wiring	15 A
Current factory wiring	15 A
Voltage CSA	300 V
Current CSA	15 A

### Other

Type of insulation material	Thermoplastic
-----------------------------	---------------

Color	Grey
Height	10.04 mm
Length	22.52 mm
Depth	19 mm
Material attachment screw	None
Material contact base	Steel
Material contact surface	Sn

#### Classification

ECLASS 11	
ECLASS 8.1	27440402
ETIM 7.0	EC002637
ETIM 6.0	EC002637
ETIM 5.0	EC002637
ETIM 4.0	EC002637

#### Product compliance

ROHS conformity status	Compliant
REACH-SVHC conformity status	Compliant

#### Fits with

Commercial Art.No.:	Article-type description:	Description:
25.352.3453.0	PCB pin header 8213 S / 4 W OB	PCB pin header, connection method depends on used socket part , 4 poles, pitch: 5.08 mm, type of packing: carton, color: grey
25.350.3453.0	PCB pin header 8213 S / 4 G OB	PCB pin header, connection method depends on used socket part , 4 poles, pitch: 5.08 mm, type of packing: carton, color: grey
99.204.9996.2	PCB pin header 8213 S / 4 W OB OF	PCB pin header, connection method depends on used socket part , 4 poles, pitch: 5.08 mm, type of packing: carton, color: white
99.234.9996.1	PCB pin header 8213 S / 4 G OB OF	PCB pin header, connection method depends on used socket part , 4 poles, pitch: 5.08 mm, type of packing: carton, color: black

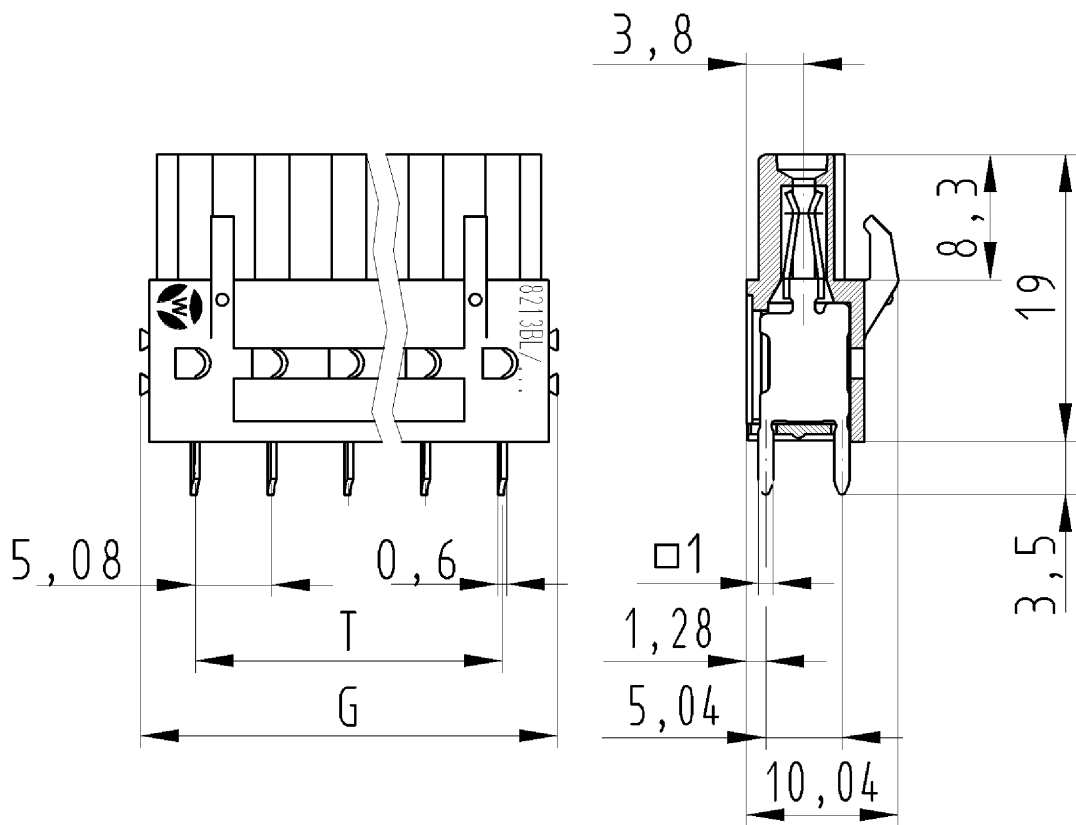

für folgende Tabellen-Zchnng.:  
 25.342.5453.F 8213 BL/.. G OB

LP.KLEMME  
 25.342.3253.0 10W  
 22.11.2007 SCJ  
 M 2:1

Weitergabe sowie Vervielfältigung dieses Dokuments, Verwertung und Mitteilung seines Inhalts sind verboten, soweit nicht ausdrücklich gestattet. The reproduction, distribution and utilization of this document as well as the communication of its contents to others without express authorization is prohibited.