

## Snubberless™, logic level and standard 8 A Triacs

### Features

- Medium current Triac
- High static and dynamic commutation
- Low thermal resistance with clip bonding
- Packages is RoHS (2002/95/EC) compliant
- 600 V  $V_{RM}$
- UL certified (ref. file E81734)

### Applications

- Value sensitive application
- General purpose ac line load switching
- Motor control circuits in power tools
- Small home appliances, lighting
- Inrush current limiting circuits
- Overvoltage crowbar protection

### Description

Available in through-hole, the T8T series of Triacs can be used as on/off or phase angle control function in general purpose ac switching where high commutation capability is required.

This series can be designed-in in many value sensitive appliances thanks to the parameters guidance provided in the following pages.

Provides insulation rated at 2500 V rms (TO-220AB insulated package).

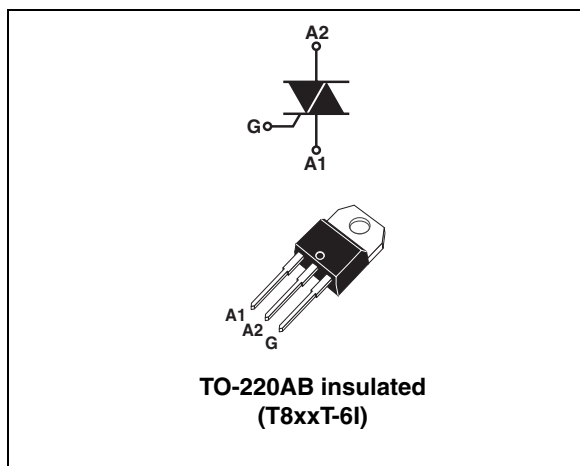

**Table 1. Device summary**

Order code	Symbol	Value
T810T-6I	$I_{GT}$ 3Q logic level	10 mA
T820T-6I T835T-6I	$I_{GT}$ 3Q Snubberless	20 / 35 mA
T825T-6I	$I_{GT}$ 4Q standard	25 mA

**TM:** Snubberless is a trademark of STMicroelectronics

# 1 Characteristics

**Table 2. Absolute ratings (limiting values;  $T_j = 25\text{ °C}$ , unless otherwise specified)**

Symbol	Parameter			Value	Unit
$I_{T(RMS)}$	On-state rms current (full sine wave)		$T_c = 97\text{ °C}$	8	A
$I_{TSM}$	Non repetitive surge peak on-state current (full cycle, $T_j$ initial = $25\text{ °C}$ )	F = 50 Hz	$t_p = 20\text{ ms}$	60	A
		F = 60 Hz	$t_p = 16.7\text{ ms}$	63	
$I^2t$	$I^2t$ Value for fusing		$t_p = 10\text{ ms}$	26	$A^2s$
di/dt	Critical rate of rise of on-state current $I_G = 2 \times I_{GT}$ $t_r \leq 100\text{ ns}$	F = 60 Hz	$T_j = 125\text{ °C}$	50	A/ $\mu s$
$V_{DSM} / V_{RSM}$	Non repetitive surge peak off-state voltage	$t_p = 10\text{ ms}$	$T_j = 25\text{ °C}$	$V_{DRM} / V_{RRM} + 100$	V
$I_{GM}$	Peak gate current	$t_p = 20\text{ }\mu s$	$T_j = 125\text{ °C}$	4	A
$P_{G(AV)}$	Average gate power dissipation		$T_j = 125\text{ °C}$	1	W
$T_{stg}$	Storage junction temperature range			- 40 to + 150	$^{\circ}C$
$T_j$	Operating junction temperature range			- 40 to + 125	$^{\circ}C$

**Table 3. Electrical characteristics ( $T_j = 25\text{ °C}$ , unless otherwise specified)**

Symbol	Test conditions	Quadrant		T8xxT				Unit
				T810T	T820T	T825T	T835T	
$I_{GT}^{(1)}$	$V_D = 12\text{ V}$ , $R_L = 30\ \Omega$	I - II - III	MAX.	10	20	25	35	mA
		IV				40		
$V_{GT}$	$V_D = V_{DRM}$ , $R_L = 30\ \Omega$ , $T_j = 25\text{ °C}$	ALL	MAX.	1.3				V
$V_{GD}$	$V_D = V_{DRM}$ , $R_L = 3.3\text{ k}\Omega$ , $T_j = 125\text{ °C}$	ALL	MIN.	0.2				V
$I_H^{(2)}$	$I_T = 500\text{ mA}$		MAX.	15	25	30	40	mA
$I_L$	$I_G = 1.2\ I_{GT}$	I - III	MAX.	20	35	40	50	mA
		IV				40		
		II		25	40	70	70	
$dV/dt^{(2)}$	$V_D = 67\% V_{DRM}$ , gate open	$T_j = 125\text{ °C}$	MIN.	100	750	500	2000	V/ $\mu$ s
		$T_j = 150\text{ °C}^{(3)}$		50	500	300	1000	
$(di/dt)^c^{(2)}$	$(dV/dt)^c = 0.1\text{ V}/\mu\text{s}$	$T_j = 125\text{ °C}$	MIN.	5.4				A/ms
	$(dV/dt)^c = 10\text{ V}/\mu\text{s}$			2		4.5		
	Without snubber				3.4		8	
	$(dV/dt)^c = 0.1\text{ V}/\mu\text{s}$	$T_j = 150\text{ °C}^{(3)}$		2.5				
	$(dV/dt)^c = 10\text{ V}/\mu\text{s}$			1		2		
	Without snubber				2		6.5	

1. Minimum  $I_{GT}$  is guaranteed at 5% of  $I_{GT}$  max.
2. For both polarities of A2 referenced to A1.
3. Derating information for excess temperature above  $T_j$  max.

**Table 4. Static characteristics**

Symbol	Test conditions		Value	Unit	
$V_T^{(1)}$	$I_{TM} = 11.3\text{ A}$ , $t_p = 380\ \mu\text{s}$	$T_j = 25\text{ °C}$	MAX.	1.60	V
$V_{TO}^{(1)}$	Threshold voltage	$T_j = 125\text{ °C}$	MAX.	0.87	V
$R_D^{(1)}$	Dynamic resistance	$T_j = 125\text{ °C}$	MAX.	60	m $\Omega$
$I_{DRM}$ $I_{RRM}$	$V_{DRM} = V_{RRM}$	$T_j = 25\text{ °C}$	MAX.	5	$\mu$ A
		$T_j = 125\text{ °C}$		1	mA
	$V_D = 0.9 \times V_{DRM}$	$T_j = 150\text{ °C}^{(2)}$	TYP.	1.9	

1. For both polarities of A2 referenced to A1.
2. Derating information for excess temperature above  $T_j$  max.

Table 5. Thermal resistance

Symbol	Parameter	Value	Unit
$R_{th(j-c)}$	Junction to case (AC)	2.8	$^{\circ}C/W$
$R_{th(j-a)}$	Junction to ambient (DC)	60	$^{\circ}C/W$

Figure 1. Maximum power dissipation versus rms on-state current

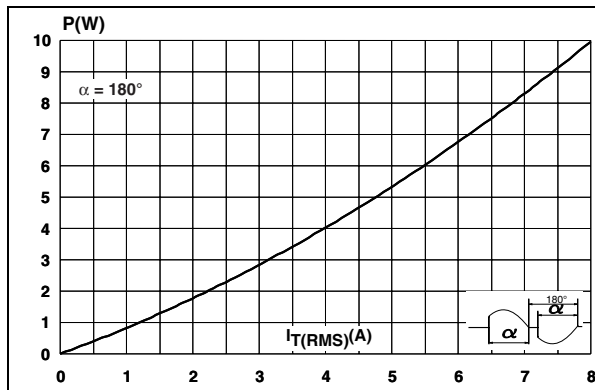

Figure 2. On-state rms current versus case temperature

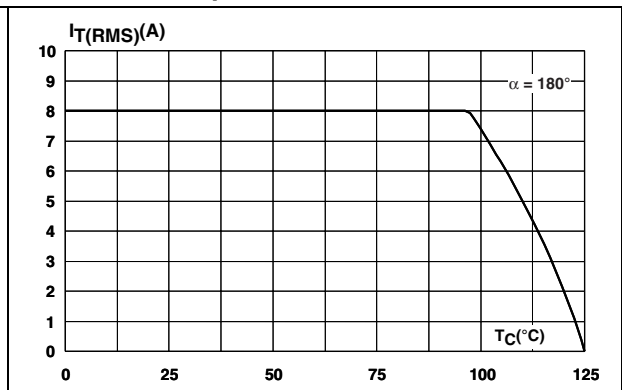

Figure 3. On-state rms current versus ambient temperature (free air convection)

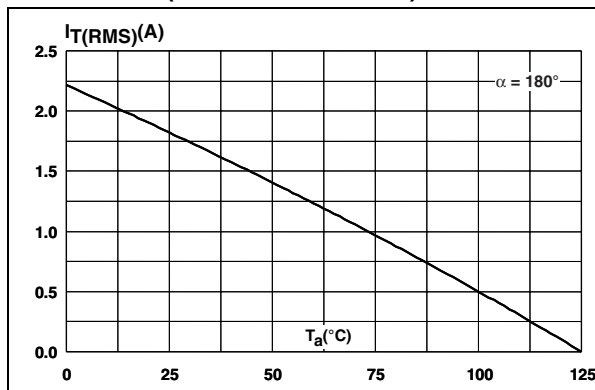

Figure 4. Relative variation of thermal impedance versus pulse duration

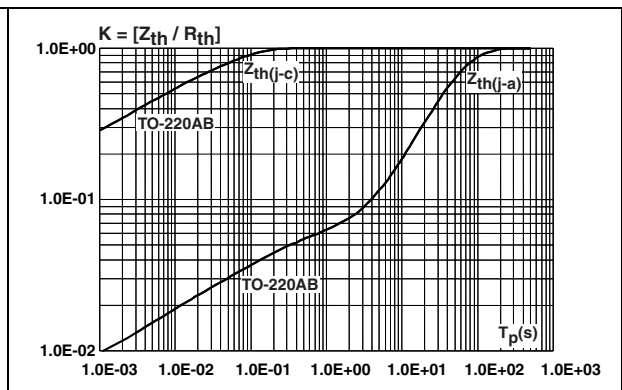

Figure 5. On-state characteristics (maximum values)

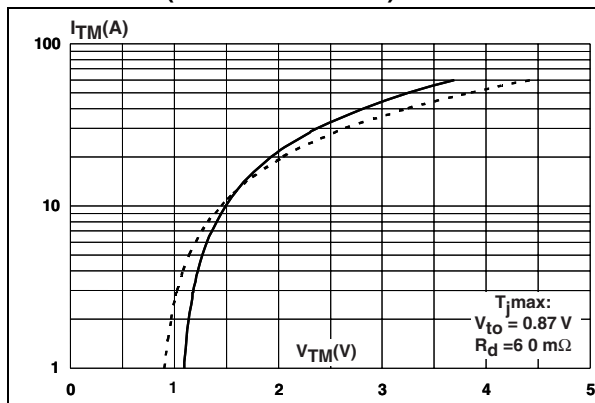

Figure 6. Surge peak on state current versus number of cycles

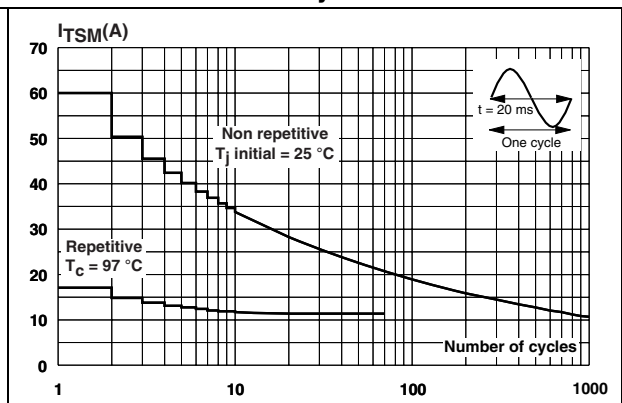

Figure 7. Non repetitive surge peak on-state current for a sinusoidal

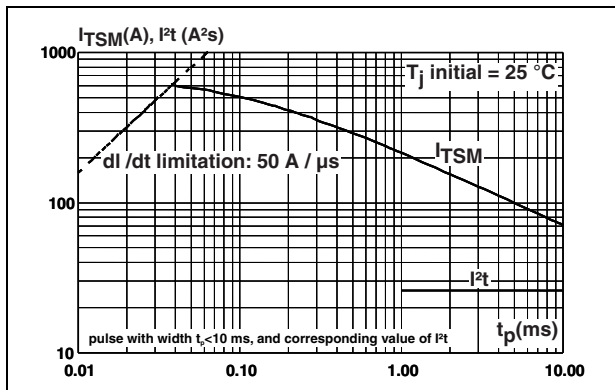

Figure 8. Relative variation of gate trigger current and gate trigger voltage versus junction temperature

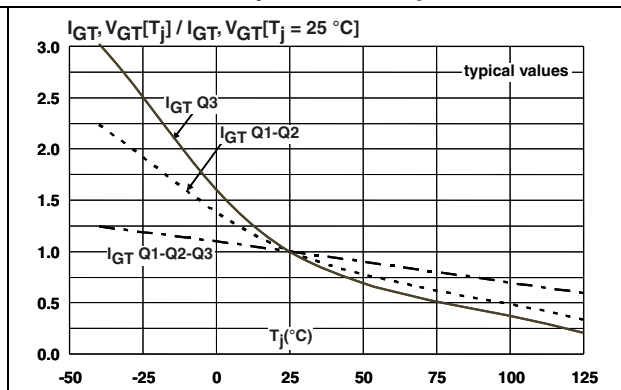

Figure 9. Relative variation of holding current and latching current versus junction temperature

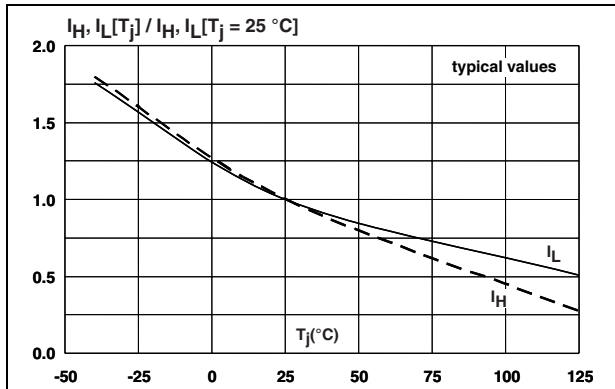

Figure 10. Relative variation of static dV/dt immunity versus junction temperature

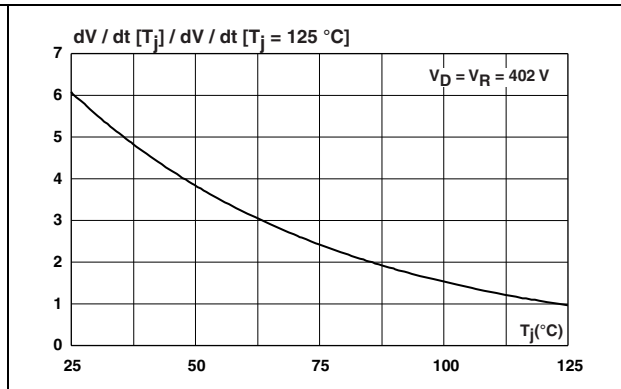

Figure 11. Relative variation of critical rate of decrease of main current versus junction temperature

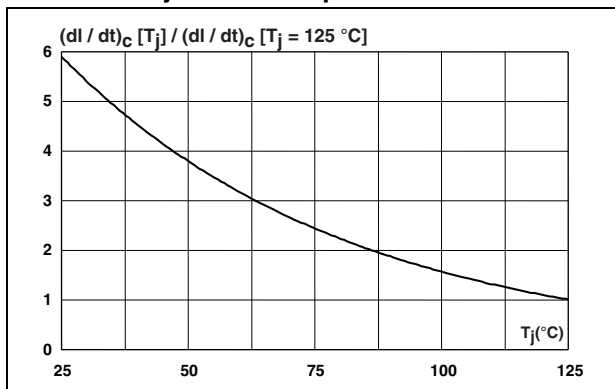
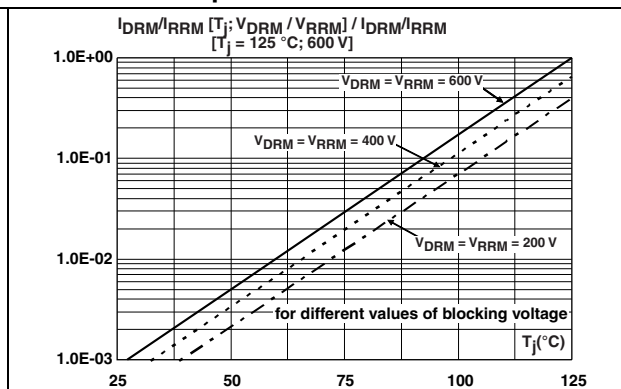
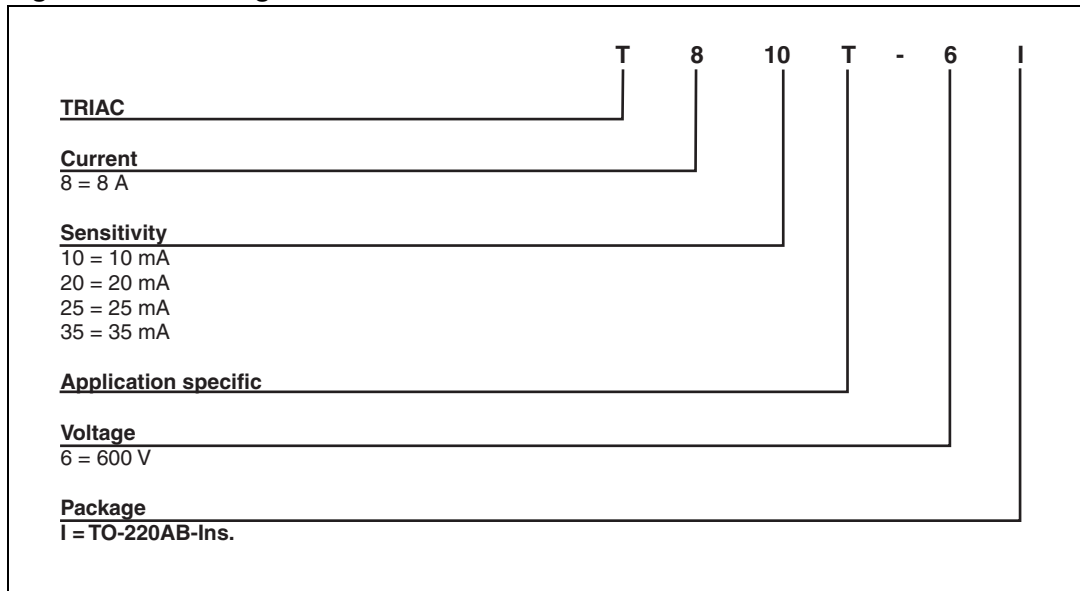

Figure 12. Relative variation of leakage current versus junction temperature



## 2 Ordering information scheme

Figure 13. Ordering information scheme



### 3 Package mechanical data

- Epoxy meets UL94, V0
- Lead-free packages

In order to meet environmental requirements, ST offers these devices in different grades of ECOPACK® packages, depending on their level of environmental compliance. ECOPACK® specifications, grade definitions and product status are available at: [www.st.com](http://www.st.com). ECOPACK® is an ST trademark.

**Table 6. TO-220AB Insulated dimensions**

Ref.	Dimensions					
	Millimeters			Inches		
	Min.	Typ.	Max.	Min.	Typ.	Max.
A	15.20		15.90	0.598		0.625
a1		3.75			0.147	
a2	13.00		14.00	0.511		0.551
B	10.00		10.40	0.393		0.409
b1	0.61		0.88	0.024		0.034
b2	1.23		1.32	0.048		0.051
C	4.40		4.60	0.173		0.181
c1	0.49		0.70	0.019		0.027
c2	2.40		2.72	0.094		0.107
e	2.40		2.70	0.094		0.106
F	6.20		6.60	0.244		0.259
ØI	3.75		3.85	0.147		0.151
I4	15.80	16.40	16.80	0.622	0.646	0.661
L	2.65		2.95	0.104		0.116
I2	1.14		1.70	0.044		0.066
I3	1.14		1.70	0.044		0.066
M		2.60			0.102	

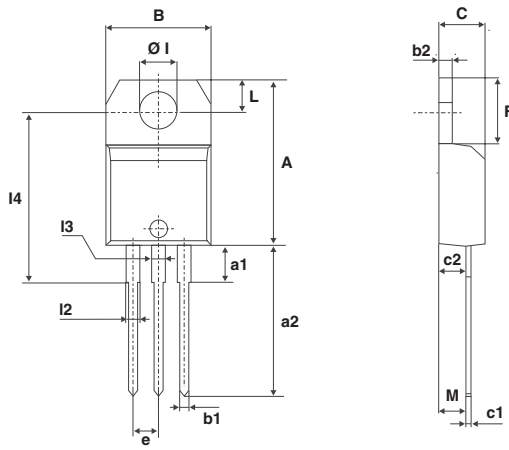

## 4 Ordering information

Table 7. Ordering information

Order code	Marking	Package	Weight	Base qty	Delivery mode
T810T-6I	T810T-6I	TO-220AB-Ins.	2.3 g	50	Tube
T820T-6I	T820T-6I				
T825T-6I	T825T-6I				
T835T-6I	T835T-6I				

## 5 Revision history

Table 8. Document revision history

Date	Revision	Changes
10-Sep-2009	1	First issue.
18-Jan-2010	2	Updated pag.1.
20-Sep-2011	3	Updated: <a href="#">Features</a> .



**Please Read Carefully:**

Information in this document is provided solely in connection with ST products. STMicroelectronics NV and its subsidiaries ("ST") reserve the right to make changes, corrections, modifications or improvements, to this document, and the products and services described herein at any time, without notice.

All ST products are sold pursuant to ST's terms and conditions of sale.

Purchasers are solely responsible for the choice, selection and use of the ST products and services described herein, and ST assumes no liability whatsoever relating to the choice, selection or use of the ST products and services described herein.

No license, express or implied, by estoppel or otherwise, to any intellectual property rights is granted under this document. If any part of this document refers to any third party products or services it shall not be deemed a license grant by ST for the use of such third party products or services, or any intellectual property contained therein or considered as a warranty covering the use in any manner whatsoever of such third party products or services or any intellectual property contained therein.

**UNLESS OTHERWISE SET FORTH IN ST'S TERMS AND CONDITIONS OF SALE ST DISCLAIMS ANY EXPRESS OR IMPLIED WARRANTY WITH RESPECT TO THE USE AND/OR SALE OF ST PRODUCTS INCLUDING WITHOUT LIMITATION IMPLIED WARRANTIES OF MERCHANTABILITY, FITNESS FOR A PARTICULAR PURPOSE (AND THEIR EQUIVALENTS UNDER THE LAWS OF ANY JURISDICTION), OR INFRINGEMENT OF ANY PATENT, COPYRIGHT OR OTHER INTELLECTUAL PROPERTY RIGHT.**

**UNLESS EXPRESSLY APPROVED IN WRITING BY TWO AUTHORIZED ST REPRESENTATIVES, ST PRODUCTS ARE NOT RECOMMENDED, AUTHORIZED OR WARRANTED FOR USE IN MILITARY, AIR CRAFT, SPACE, LIFE SAVING, OR LIFE SUSTAINING APPLICATIONS, NOR IN PRODUCTS OR SYSTEMS WHERE FAILURE OR MALFUNCTION MAY RESULT IN PERSONAL INJURY, DEATH, OR SEVERE PROPERTY OR ENVIRONMENTAL DAMAGE. ST PRODUCTS WHICH ARE NOT SPECIFIED AS "AUTOMOTIVE GRADE" MAY ONLY BE USED IN AUTOMOTIVE APPLICATIONS AT USER'S OWN RISK.**

Resale of ST products with provisions different from the statements and/or technical features set forth in this document shall immediately void any warranty granted by ST for the ST product or service described herein and shall not create or extend in any manner whatsoever, any liability of ST.

ST and the ST logo are trademarks or registered trademarks of ST in various countries.

Information in this document supersedes and replaces all information previously supplied.

The ST logo is a registered trademark of STMicroelectronics. All other names are the property of their respective owners.

© 2011 STMicroelectronics - All rights reserved

STMicroelectronics group of companies

Australia - Belgium - Brazil - Canada - China - Czech Republic - Finland - France - Germany - Hong Kong - India - Israel - Italy - Japan - Malaysia - Malta - Morocco - Philippines - Singapore - Spain - Sweden - Switzerland - United Kingdom - United States of America

[www.st.com](http://www.st.com)