

## Data sheet

Commercial Art.No.: 25.398.6853.0

PCB pin header 8413 S / 8 GF OB

PCB pin header with pin header, connection method depends on used socket part , 8 poles, pitch: 7.62 mm, type of packing: carton, color: grey

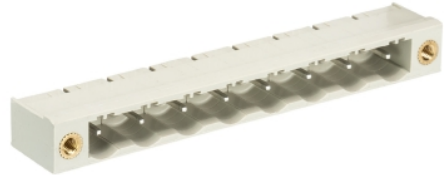

Commercial Art.No.	25.398.6853.0
EAN	4015573201743
Order Unit	50

Certificates / Approvals



## Technical data

### General

Modular spacing	7.62 mm
Soldering process	Wave soldering
Packaging	Carton
Number of poles	8
Number of levels	1
Marking	No
Fastening	Flange
Mating direction towards (circuit) board	90°

### Technical data

Rated current	12 A
Overvoltage Category I	1000 V
Overvoltage Category II	400 V
Overvoltage Category III	250 V
Rated impulse voltage	4 kV

### Technical Data UL/CSA

Voltage UL	300 V
Current field wiring	15 A
Current factory wiring	15 A
Voltage CSA	300 V
Current CSA	15 A

### Other

Type of insulation material	Thermoplastic
Color	Grey
Height	12 mm
Length	71.38 mm
Depth	8.4 mm
Material contact base	CuZn

Material contact surface	Sn
--------------------------	----

**Classification**

ECLASS 8.1	27440402
ETIM 7.0	EC002637
ETIM 6.0	EC002637
ETIM 5.0	EC002637
ETIM 4.0	EC002637

**Product compliance**

ROHS conformity status	Compliant/Exempted
ROHS exceptions	III-6(c)
REACH-SVHC conformity status	Duty-To-Declare
REACH-SVHC substances	Lead
REACH-SVHC CAS numbers	7439-92-1

**Fits with**

Commercial Art.No.:	Article-type description:	Description:
25.324.6853.0	PCB connector 8413 B / 8 F OB	PCB female connector with screw connection with rising cage clamp system, 8 poles, max. cross section: 2.5 mm <sup>2</sup> , pitch: 7.62 mm, type of packing: carton, color: grey
25.324.4853.0	PCB connector 8413 B / 8 F	PCB female connector with screw connection with rising cage clamp system, 8 poles, printed version, max. cross section: 2.5 mm <sup>2</sup> , pitch: 7.62 mm, type of packing: carton, color: grey
25.881.3853.0	PCB connector 8413 BFK / 8 TOP F OB	PCB female connector with tension spring connection, 8 poles, max. cross section: 2.5 mm <sup>2</sup> , pitch: 7.62 mm, type of packing: carton, color: grey
25.881.0853.0	PCB connector 8413 BFK / 8 TOP F	PCB female connector with tension spring connection, 8 poles, printed version, max. cross section: 2.5 mm <sup>2</sup> , pitch: 7.62 mm, type of packing: carton, color: grey

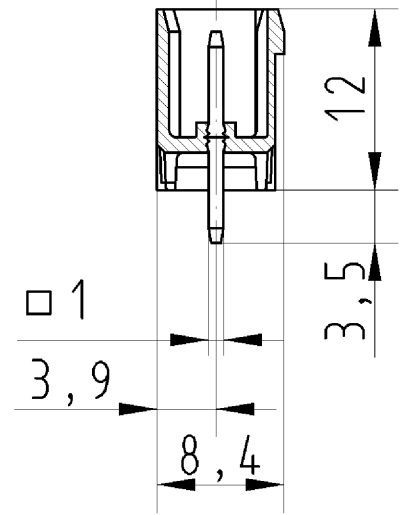
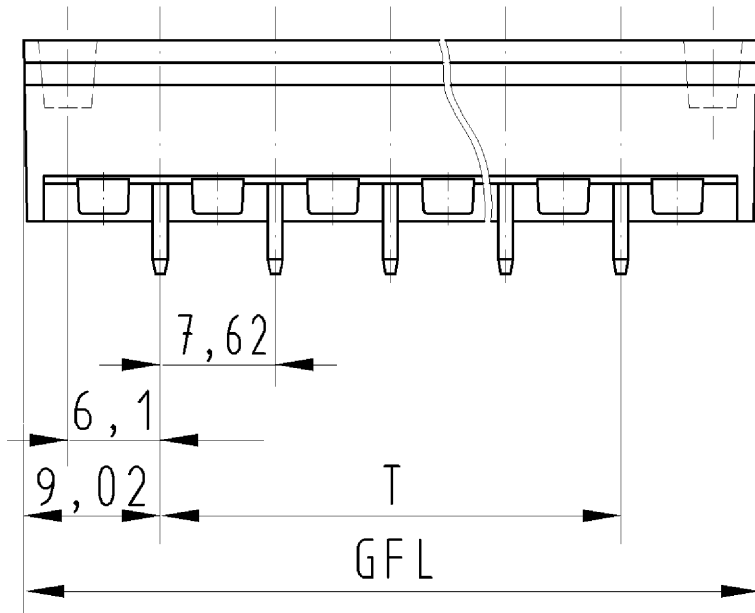

Weitergabe sowie Vervielfältigung dieses Dokuments, Verwertung und Mitteilung seines Inhalts sind verboten, soweit nicht ausdrücklich gestattet. The reproduction, distribution and utilization of this document as well as the communication of its contents to others without express authorization is prohibited.

für folgende Tabellen-Zchnng.:  
 25.398.6253.0 8413 S/... GF

LP-STIFTLLEISTE  
 25.398.6253.0 10W  
 09.11.2007 SCJ  
 M 2:1