

# HDSM-281B/283B

0.28inch (7.0mm)

Single digit surface mount LED display



## Data Sheet

### Description

This is 0.28 inch (7.0mm) height single digit display. This device utilizes InGaN/SiC blue LED chips. This device with top surface gray and white segments.

### Ordering Information

Blue	Description
HDSM-281B	Common Anode, Upper and Lower Decimal
HDSM-283B	Common Cathode, Upper and Lower Decimal

### Features

- 0.28" digit height
- Low current operation
- Excellent characters appearance
- Available in CA and CC
- 1000 pieces per reel
- Moisture Sensitivity Level: Level 3
- RoHS compliant

### Package Dimensions

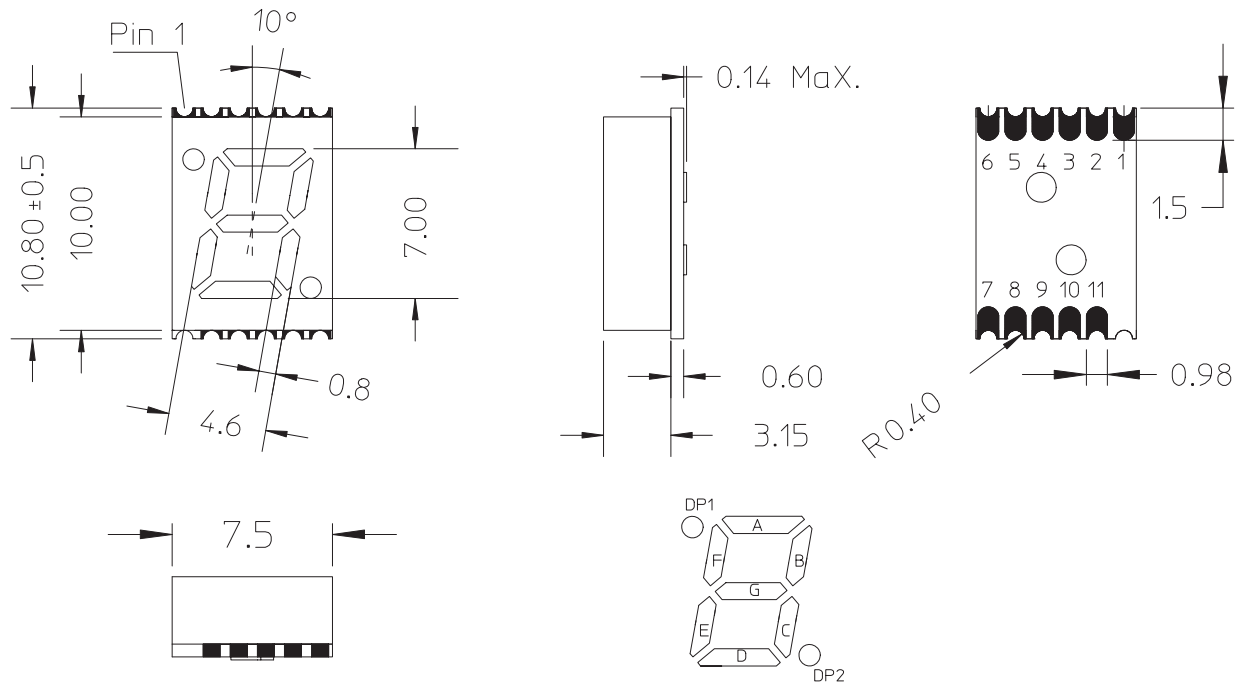

### Notes:

All dimensions are in millimeters (inches).  
Tolerance: ± 0.25mm (0.01") unless otherwise noted.

**CAUTION:** LEDs are Class 1A ESD sensitive per JESD22-A114C.01.  
Please observe appropriate precautions during handling and processing.

### Pin Connection (Common Anode)

Pin No.	Connection
1	CATHODE G
2	CATHODE DP1
3	CATHODE F
4	COMMON ANODE
5	CATHODE A
6	CATHODE B
7	CATHODE DP2
8	CATHODE C
9	COMMON ANODE
10	CATHODE D
11	CATHODE E

### Pin Connection (Common Cathode)

Pin No.	Connection
1	ANODE G
2	ANODE DP1
3	ANODE F
4	COMMON CATHODE
5	ANODE A
6	ANODE B
7	ANODE DP2
8	ANODE C
9	COMMON CATHODE
10	ANODE D
11	ANODE E

### Internal Circuit Diagram (Common Anode)

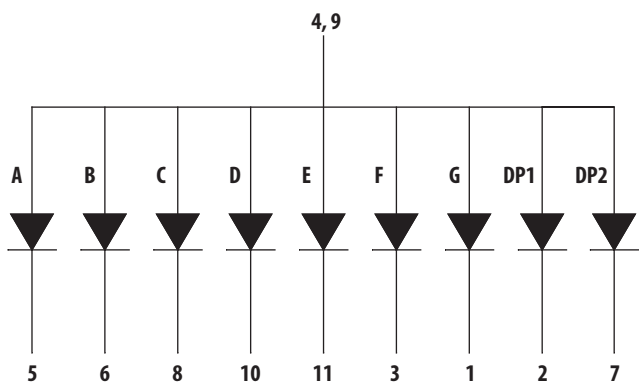

### Internal Circuit Diagram (Common Cathode)

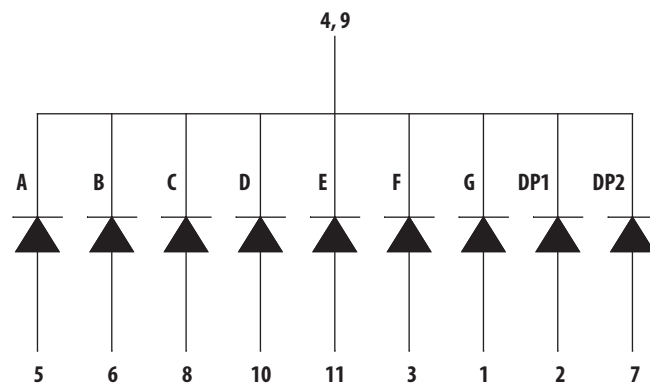

**Absolute Maximum Ratings @ T<sub>A</sub>=25°C**

Parameter	Blue	Unit
Power Dissipation Per Segment	100	mW
Peak Forward Current Per Segment (1/10 Duty Cycle, 0.1ms pulse width)	80	mA
Continuous Forward Current Per Segment Derating Linearly From 25°C Per Segment	25 0.25	mA mA/°C
Reverse Voltage Per Segment	5	V
Operating Temperature Range	-40°C to +105°C	
Storage Temperature Range	-40°C to +105°C	

Caution in ESD: Static Electricity and surge damages the LED. It is recommended to use a wrist strap or anti-electrostatic glove when handling the LED. All devices, equipment and machinery must be properly grounded.

**Electrical / Optical Characteristics @ T<sub>A</sub>=25°C****Blue**

Parameter	Symbol	Min.	Typ.	Max.	Unit	Test Condition
Average Luminous Intensity	I <sub>v</sub>	3.4	6	–	mcd	I <sub>F</sub> = 10 mA
Emission Wavelength	λ <sub>p</sub> /λ <sub>d</sub>	–	462/470	–	nm	I <sub>F</sub> = 20 mA
Spectral Line Half-Width	Δλ	–	26	–	nm	I <sub>F</sub> = 20 mA
Forward Voltage, Per Segment	V <sub>F</sub>	–	3.3	4.0	V	I <sub>F</sub> = 20 mA
Reverse Current, Per Segment	I <sub>R</sub>	–	–	100	μA	V <sub>R</sub> = 5 V
Luminous Intensity Matching Ratio	I <sub>v-m</sub>	–	–	2:1	–	I <sub>F</sub> = 10 mA

Typical Electrical / Optical characteristic Curves @  $T_A=25^\circ\text{C}$   
Blue

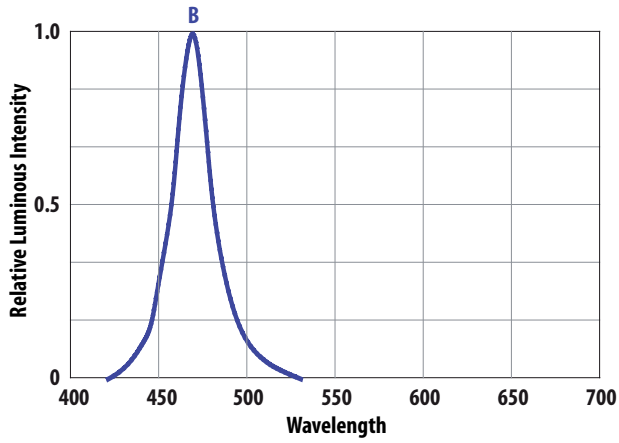

Figure 1. Relative luminous intensity vs. wavelength

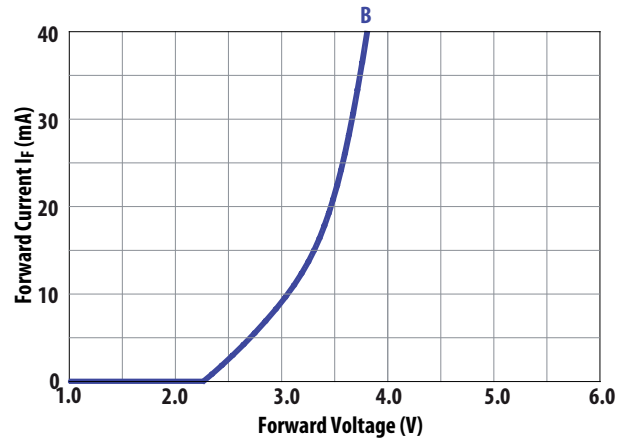

Figure 2. Forward current vs. forward voltage

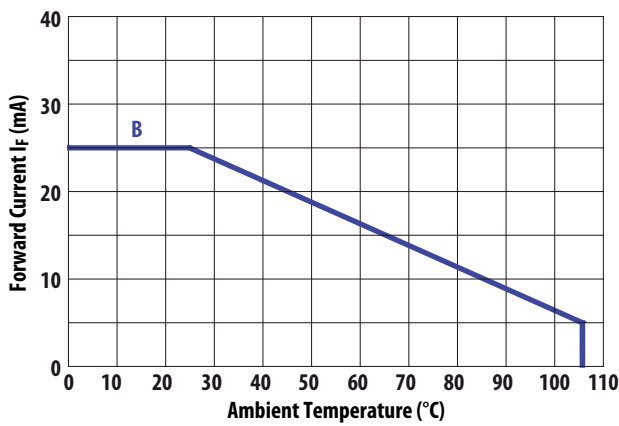

Figure 3. Allowable DC current vs. ambient temperature

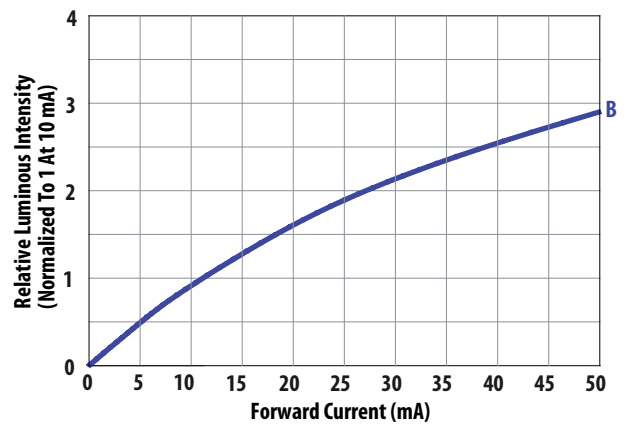

Figure 4. Relative intensity vs. forward current

## Intensity Bin Limit (mcd)

### Blue

Iv Bin Category	Min	Max
L	3.401	5.400
M	5.401	8.600
N	8.601	13.700

Tolerance +/-15%

Note:

1. Bin categories are established for classification of products. Products may not be available in all categories. Please contact your Avago representative for information on currently available bins.

## SMT Soldering Profile

### Pb free reflow soldering Profile

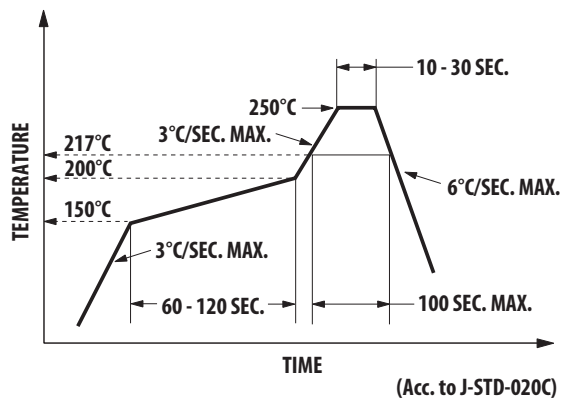

Notes:

1. The peak temperature refers to the peak package body temperature.
2. Number of reflow process shall be limited to maximum 2 times only. Cooling process to normal temperature is required between first and second soldering process.

## Recommended soldering pattern (unit: mm)

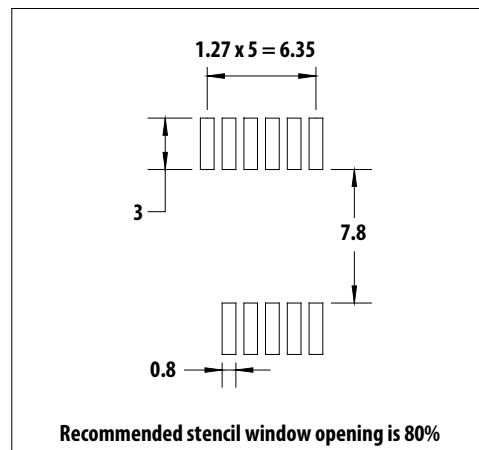

## Tape Specification (unit: mm)

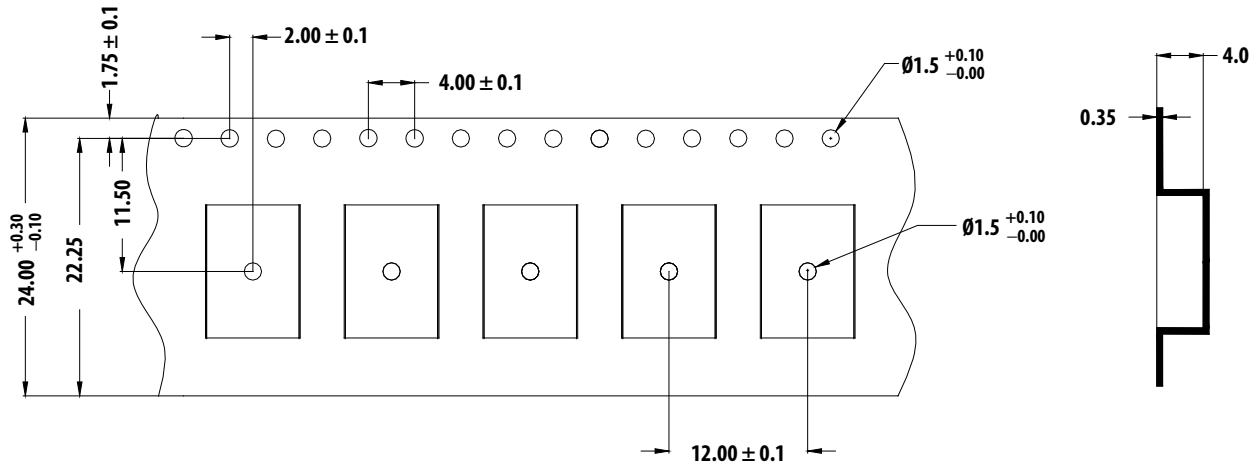

For product information and a complete list of distributors, please go to our web site: [www.avagotech.com](http://www.avagotech.com)

Avago, Avago Technologies, and the A logo are trademarks of Avago Technologies in the United States and other countries.  
Data subject to change. Copyright © 2005-2011 Avago Technologies. All rights reserved.  
AV02-1645EN - March 17, 2011

**AVAGO**  
TECHNOLOGIES