

Data sheet

Commercial Art.No.: 25.626.3453.0

PCB pin header 8813 S / 4 GF OB

PCB pin header with pin header, connection method depends on used socket part , 4 poles, pitch: 3.81 mm, type of packing: carton, color: grey

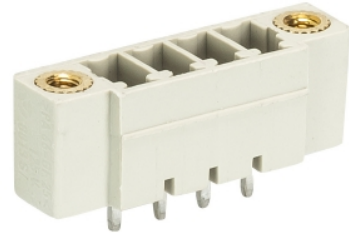

Commercial Art.No.	25.626.3453.0
EAN	4015573341968
Order Unit	50

Certificates / Approvals



Technical data

General

Modular spacing	3.81 mm
Soldering process	Wave soldering
Packaging	Carton
Number of poles	4
Number of levels	1
Marking	No
Fastening	Flange
Mating direction towards (circuit) board	90°

Technical data

Rated current	8 A
Overvoltage Category I	690 V
Overvoltage Category II	250 V
Overvoltage Category III	125
Rated impulse voltage	2.5 kV

Technical Data UL/CSA

Voltage UL	300 V
Current field wiring	8 A
Current factory wiring	8 A
Voltage CSA	300 V
Current CSA	5 A

Other

Type of insulation material	Thermoplastic
Color	Grey

Height	9.2 mm
Length	25.63 mm
Depth	7.15 mm
Material contact base	CuZn
Material contact surface	Sn

Classification

ECLASS 11	
ECLASS 8.1	27440402
ETIM 7.0	EC002637
ETIM 6.0	EC002637
ETIM 5.0	EC002637
ETIM 4.0	EC002637

Product compliance

ROHS conformity status	Compliant/Exempted
ROHS exceptions	III-6(c)
REACH-SVHC conformity status	Duty-To-Declare
REACH-SVHC substances	Lead
REACH-SVHC CAS numbers	7439-92-1

Fits with

Commercial Art.No.:	Article-type description:	Description:
25.621.3453.0	PCB connector 8813 B / 4 F OB	PCB female connector with screw connection with rising cage clamp system, 4 poles, max. cross section: 1.5 mm ² , pitch: 3.81 mm, type of packing: carton, color: grey
25.621.0453.0	PCB connector 8813 B / 4 F	PCB female connector with screw connection with rising cage clamp system, 4 poles, printed version, max. cross section: 1.5 mm ² , pitch: 3.81 mm, type of packing: carton, color: grey
25.623.3453.0	PCB connector 8813 B / 4 VR F OB	PCB female connector with screw connection with rising cage clamp system, 4 poles, max. cross section: 1.5 mm ² , pitch: 3.81 mm, type of packing: carton, color: grey
25.623.0453.0	PCB connector 8813 B / 4 VR F	PCB female connector with screw connection with rising cage clamp system, 4 poles, printed version, max. cross section: 1.5 mm ² , pitch: 3.81 mm, type of packing: carton, color: grey
25.625.3453.0	PCB connector 8813 B / 4 VL F OB	PCB female connector with screw connection with rising cage clamp system, 4 poles, max. cross section: 1.5 mm ² , pitch: 3.81 mm, type of packing: carton, color: grey
25.625.0453.0	PCB connector 8813 B / 4 VL F	PCB female connector with screw connection with rising cage clamp system, 4 poles, printed version, max. cross section: 1.5 mm ² , pitch: 3.81 mm, type of packing: carton, color: grey

für folgende Tabellen-Zchnng.:
25.626.3253.0 8813 S/...GF

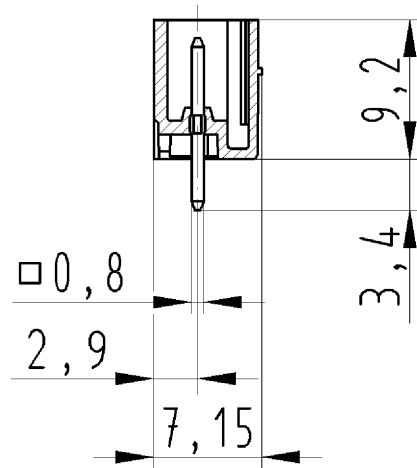
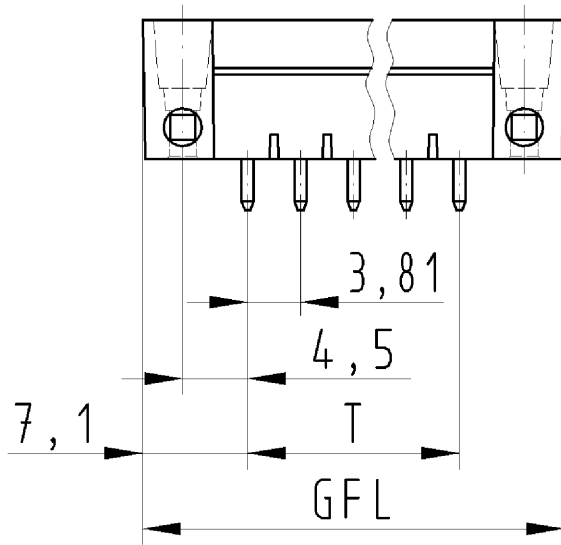

LP-STIFTLLEISTE
25.626.3253.0 10W
24.10.2007 DÜT
M 2:1