

DETAILS

Product Number	CA11934_EMILY-W
Family	Emily
Type	Assembly
Color	clear
Diameter	26 mm
Height	14,9 mm
Style	round
Optic Material	PMMA
Holder Material	
Fastening	tape, pin
Status	production ready
ROHS Compliant	Yes
Date Updated	9/06/2016



OPTICAL PROPERTIES

LED	Viewing	Light	Effi-		Connector
	Angle	Beam	ciency	cd/lm	
XM-L	36 deg	Wide	86 %	-	-
XP-E	39 deg	Wide	86 %	1.600	-
XP-G	40 deg	Wide	86 %	1.500	-
XM-L HVW	sim: 36	Wide	86 %	-	-
XT-E	36 deg	Wide	-	1.500	-
XP-G2	38 deg	Wide	84 %	1.700	-
XP-E2	39 deg	Wide	84 %	1.700	-
XM-L2	39 deg	Wide	86 %	1.700	-
XP-L	38 deg	Wide	87 %	1.710	-
XP-L HI	36 deg	Wide	86 %	1.800	-
XHP35 HD	39 deg	Wide	83 %	1.600	-
LUXEON Rebel ES	40 deg	Wide	88 %	-	-
LUXEON Rebel	40 deg	Wide	86 %	-	-
LUXEON A	40 deg	Wide	84 %	-	-
NCSxx19A	40 deg	Wide	86 %	-	-
NVSxx19A	40 deg	Wide	86 %	-	-
NS9x383	34 deg	Wide	84 %	1.800	-
NCSxx19B	sim: 45	Wide	sim: 86 %	sim: 1.000	-
Oslo SSL 80	40 deg	Wide	86 %	1.250	-
Oslo SSL 150	40 deg	Wide	86 %	-	-
Oslo Square EC	38 deg	Wide	84 %	1.860	-
Oslo Black Flat	sim: 32	Wide	sim: 94 %	sim: 3.500	-
Oslo Black	sim: 36	Wide	sim: 96 %	sim: 2.800	-
LH351B	38 deg	Wide	88 %	1.800	-
LH351Z	39 deg	Wide	85 %	1.700	-



PRODUCT DATASHEET

Emily series

last update 9/6/2016

OPTICAL PROPERTIES

LED	Viewing Angle	Light Beam	Efficiency	cd/lm	Connector
Z5	40 deg	Wide	86 %	-	-
Z8Y22P	34 deg	Wide	89 %	1.700	-
Double Dome (GM2BB)	40 deg	Wide	86 %	-	-

Relative intensity of CA11934_EMILY-W_(SQ EC)

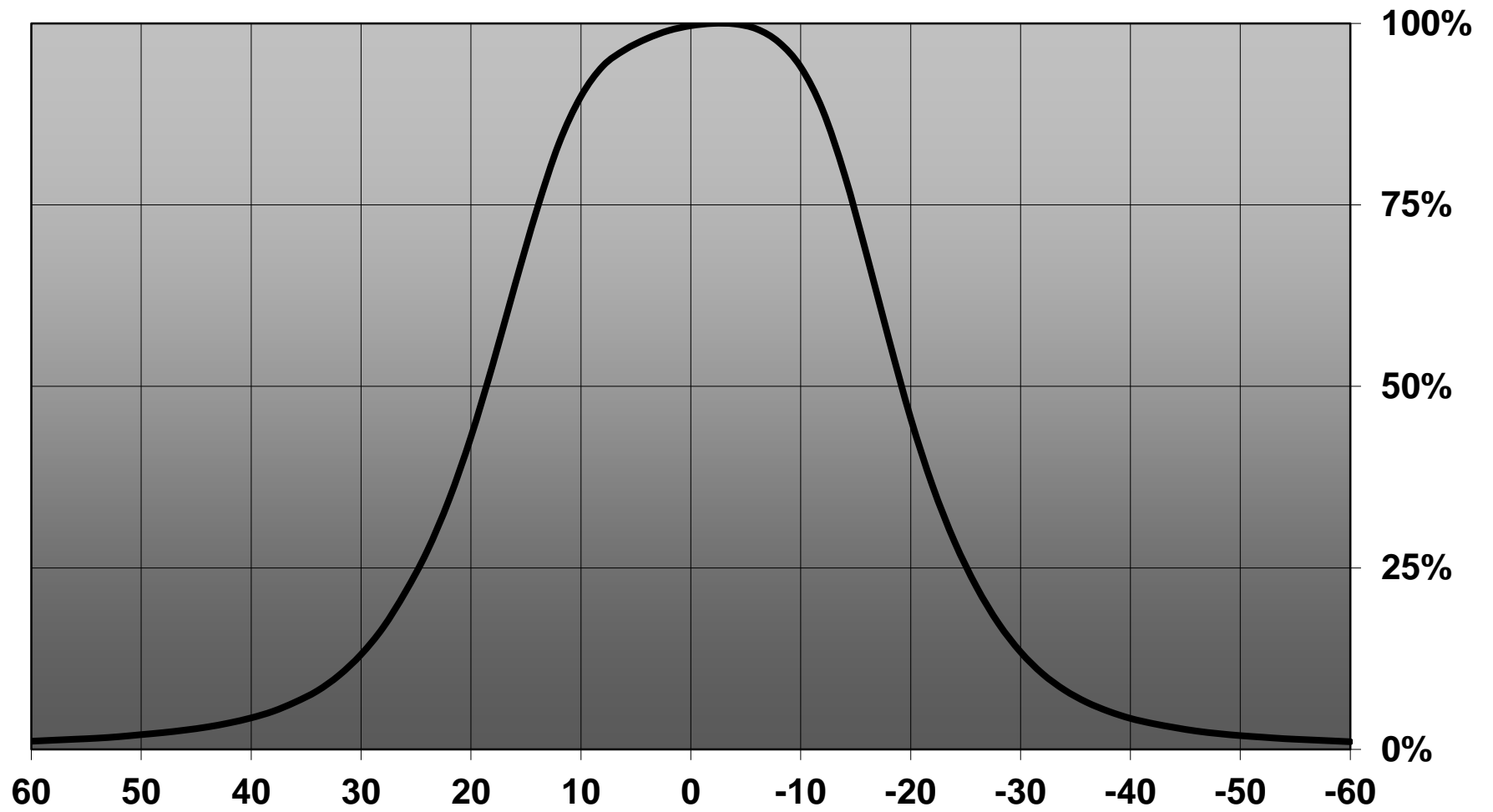

D

C

B

A

4

4

Bottom view

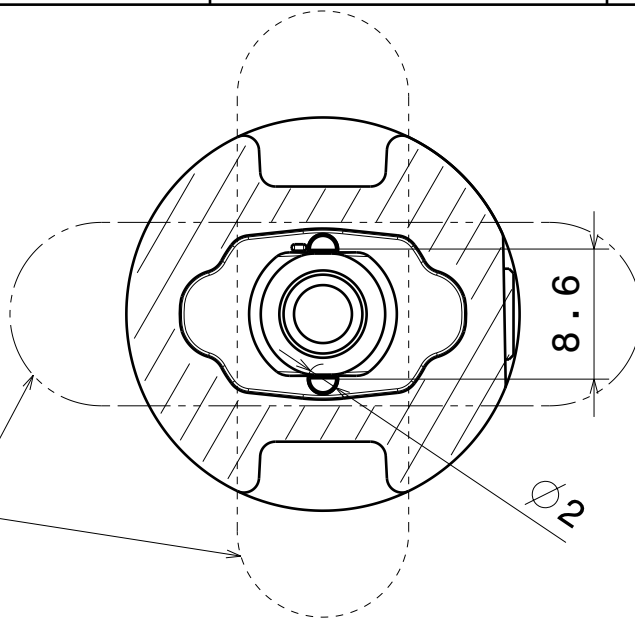

Beam direction Emily-0-90

Beam direction Emily-0

3

3

Front view

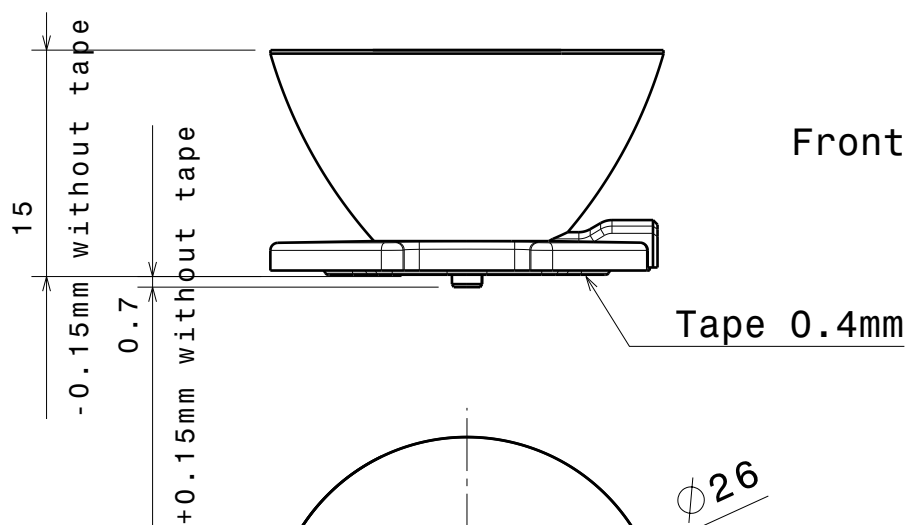

Tape 0.4mm

2

2

Top view

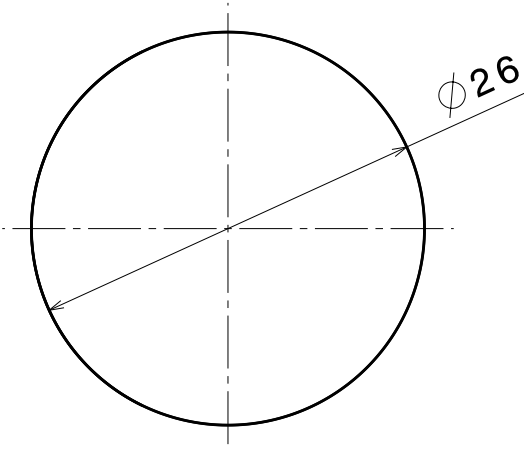

Materials:
 Lens PMMA
 Tape PU Foam with adhesive

Part no.s:
 CA11387_Emily-SS
 CA11388_Emily-M
 CA11389_Emily-0
 CA11390_Emily-0-90
 CA11391_Emily-M2

Tolerances if not otherwise shown
 According to DIN ISO 2768-1
 Linear measures:
 up to 30mm class M, otherwise class C
 According to DIN ISO 2768-2
 Form and position: class L

LEDiL LediL Oy
 Salorankatu 10
 FIN 24240 SALO
 Finland

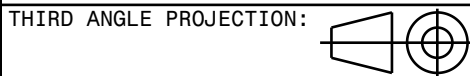

DRAWING TITLE
Datasheet Emily series lens

This drawing is the property of LEDiL Oy. It may not be reproduced, copied or communicated without a written agreement with LEDiL Oy.

SIZE	PART NUMBER
A4	

SCALE	2:1	WEIGHT		SHEET	1/1
-------	-----	--------	--	-------	-----

D

A

1

Luminaire: LEDiL Oy CA11934_EMILY-W_(XP-G2) Eff.84%
Lamps: 1 x Cree XP-G2 (98lm@250mA)

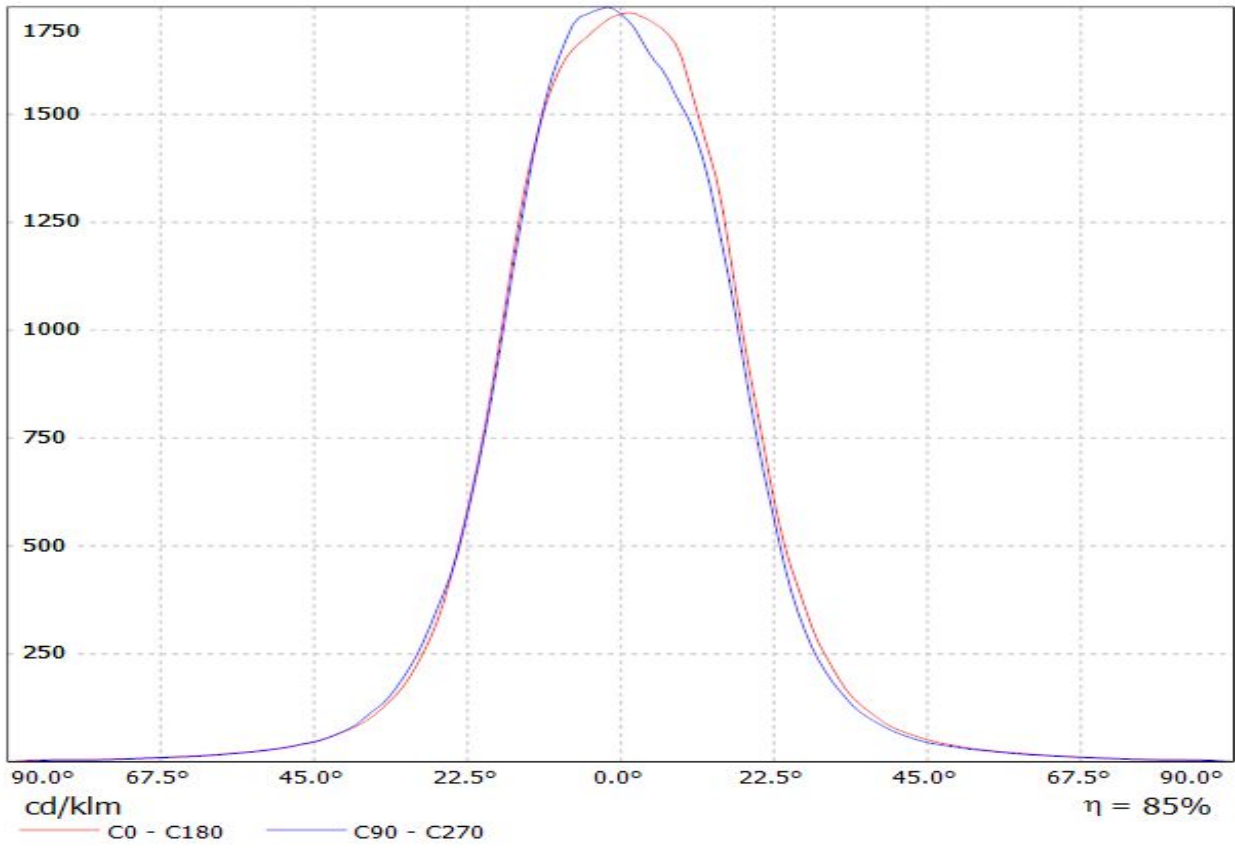

Luminaire: LEDil Oy CA11934_EMILY-W_(XP-E2)

Lamps: 1 x Cree XP-E2 (XPEBWT-L1-7B4-Q4-0-01) 78.62lm @ 250mA P=0.8W I=250mA

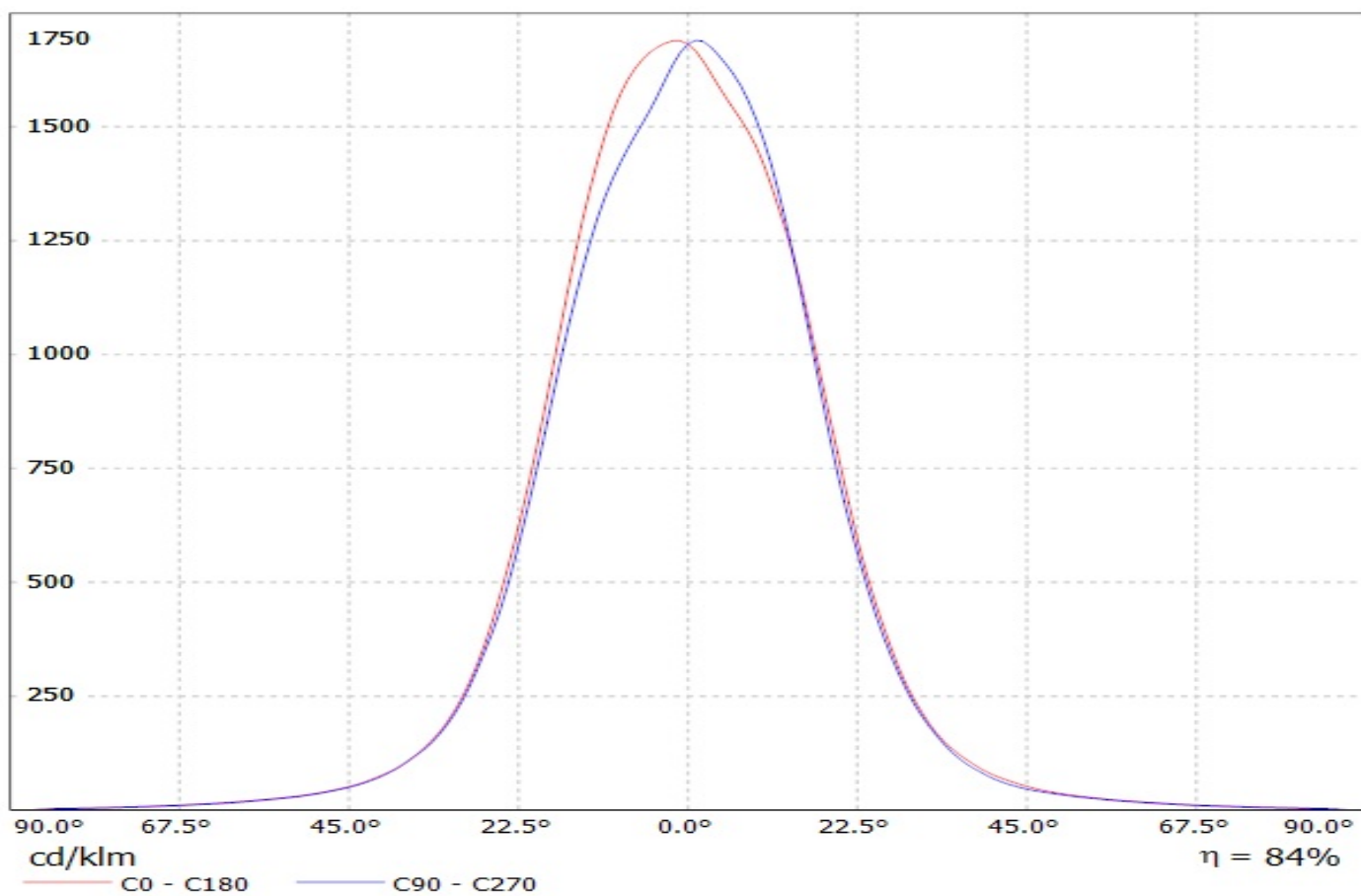

Luminaire: LEDil Oy CA11934_EMILY-W_(XM-L2) Efficiency=86%
Lamps: 1 x Cree XM-L2 (XMLBWT-0-7B4-T30-0L-0001) 91lm @ 250mA CCT=3200K P=0.7W I=250mA

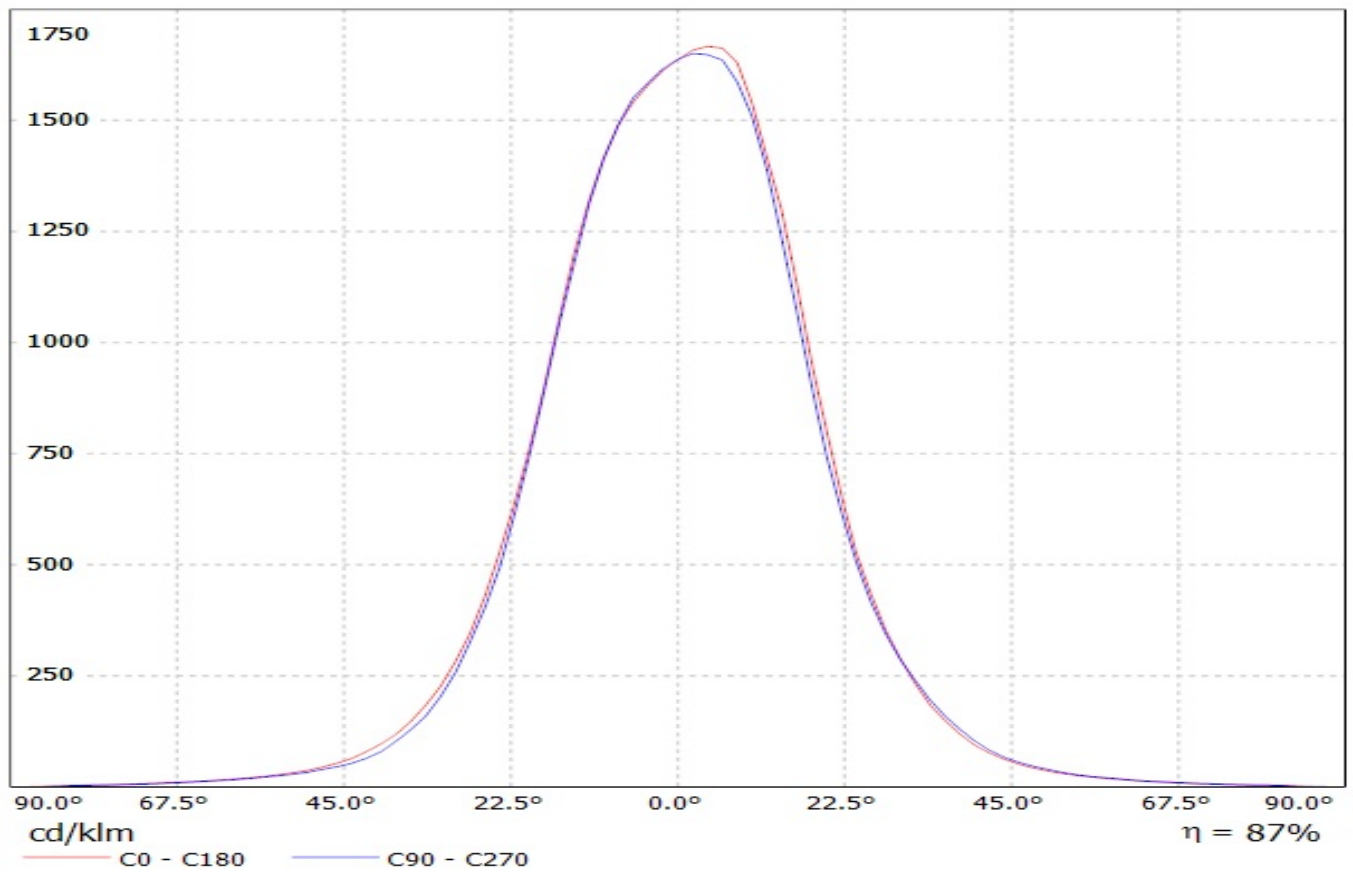

Luminaire: Ledil Oy CA11934_EMILY-W_(XP-L) Efficiency= 87%
Lamps: 1 x Cree XP-L 125lm @ 250mA CCT= P=0.72W I=250mA

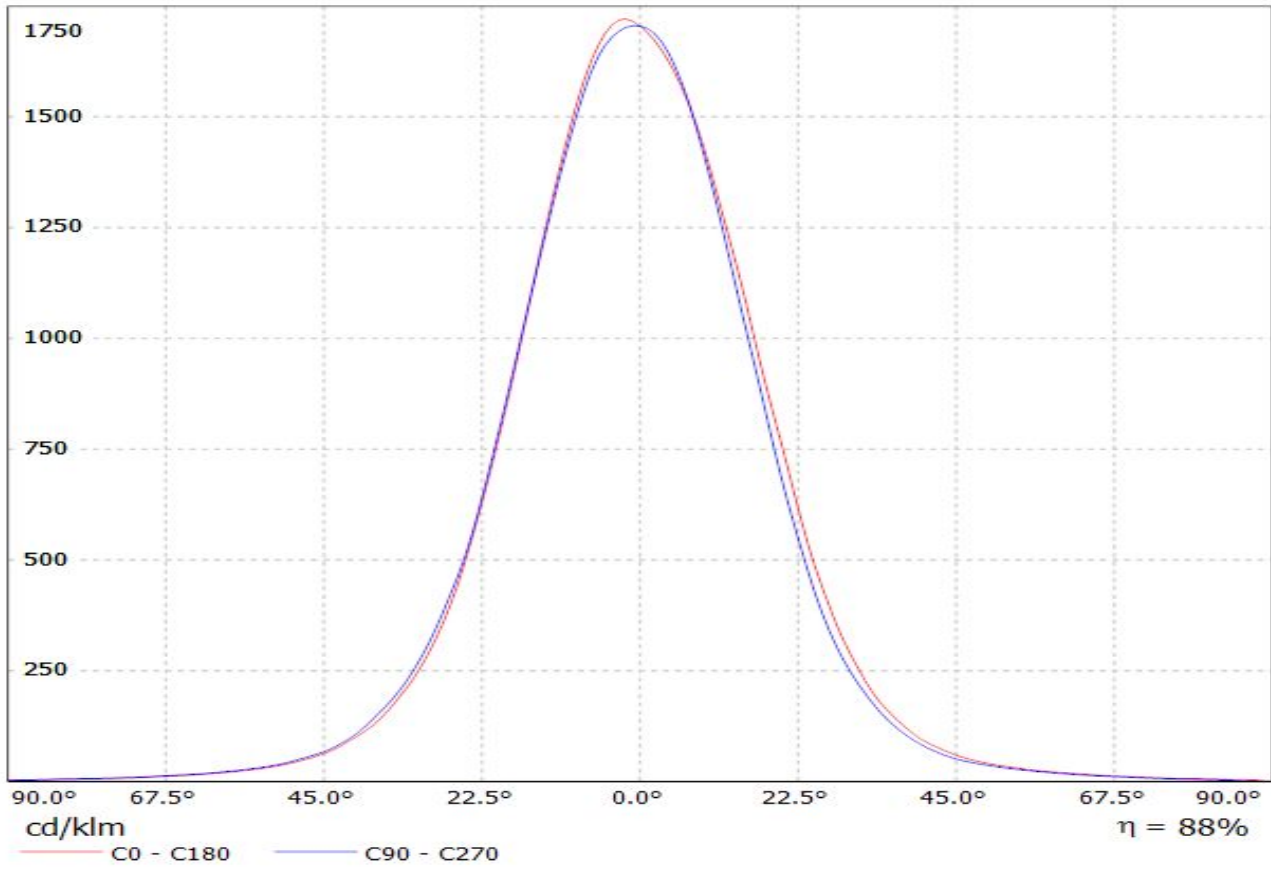

Luminaire: LEDiL Oy CA11934_EMILY-W_(XP-L_HI)

Lamps: 1 x Cree_XP-L_HI_114.406lm@250mA_P=0.745352W_I=0.2499A

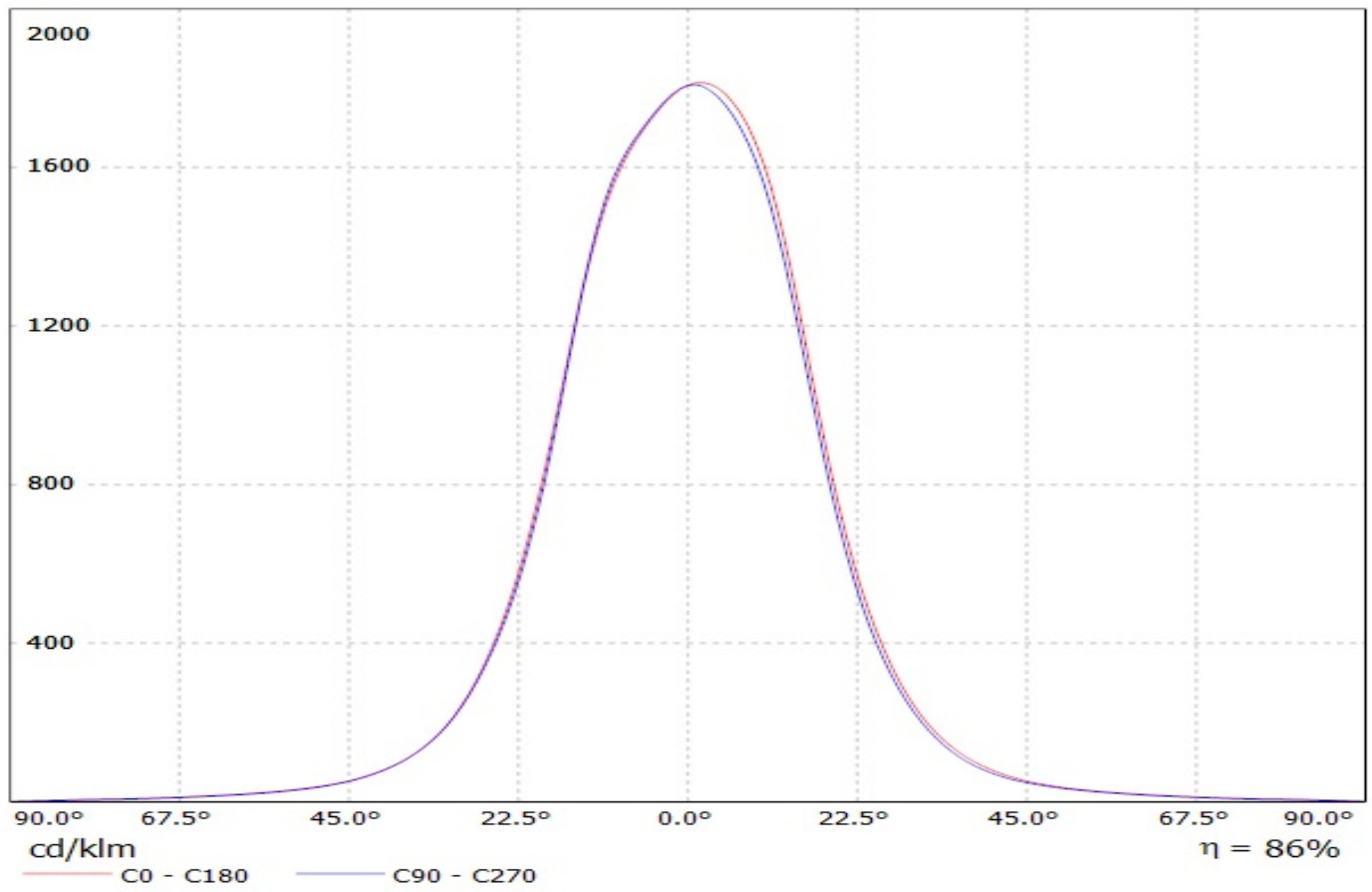

Luminaire: LEDiL Oy
Lamps: 1 x CA11934_EMILY-W_(XHP35)

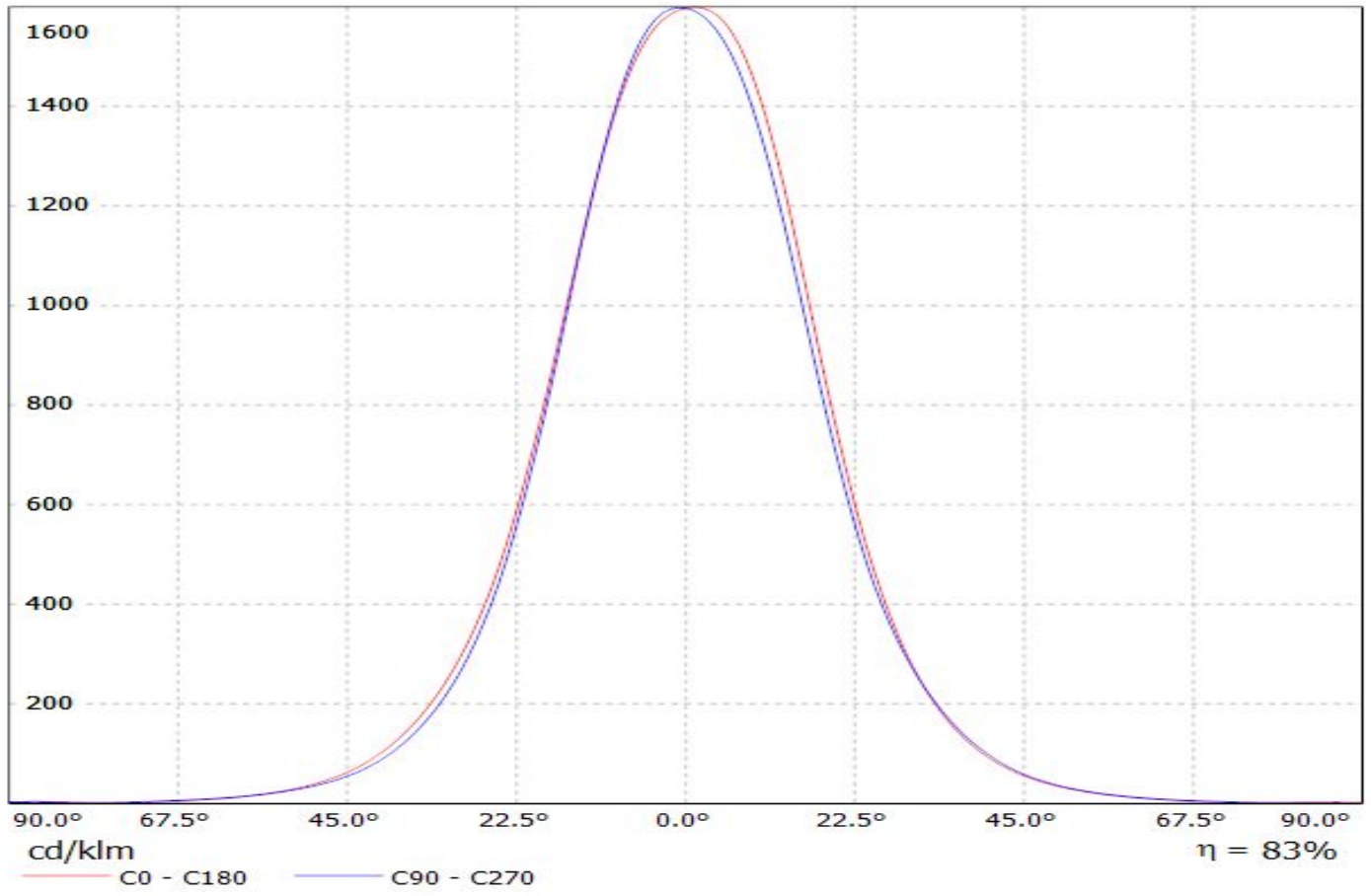

Luminaire: LEDiL Oy CA11934_EMILY-W_(NS9x383) Eff.84,3%
Lamps: 1 x Nichia NS9x383 (105lm@250mA)

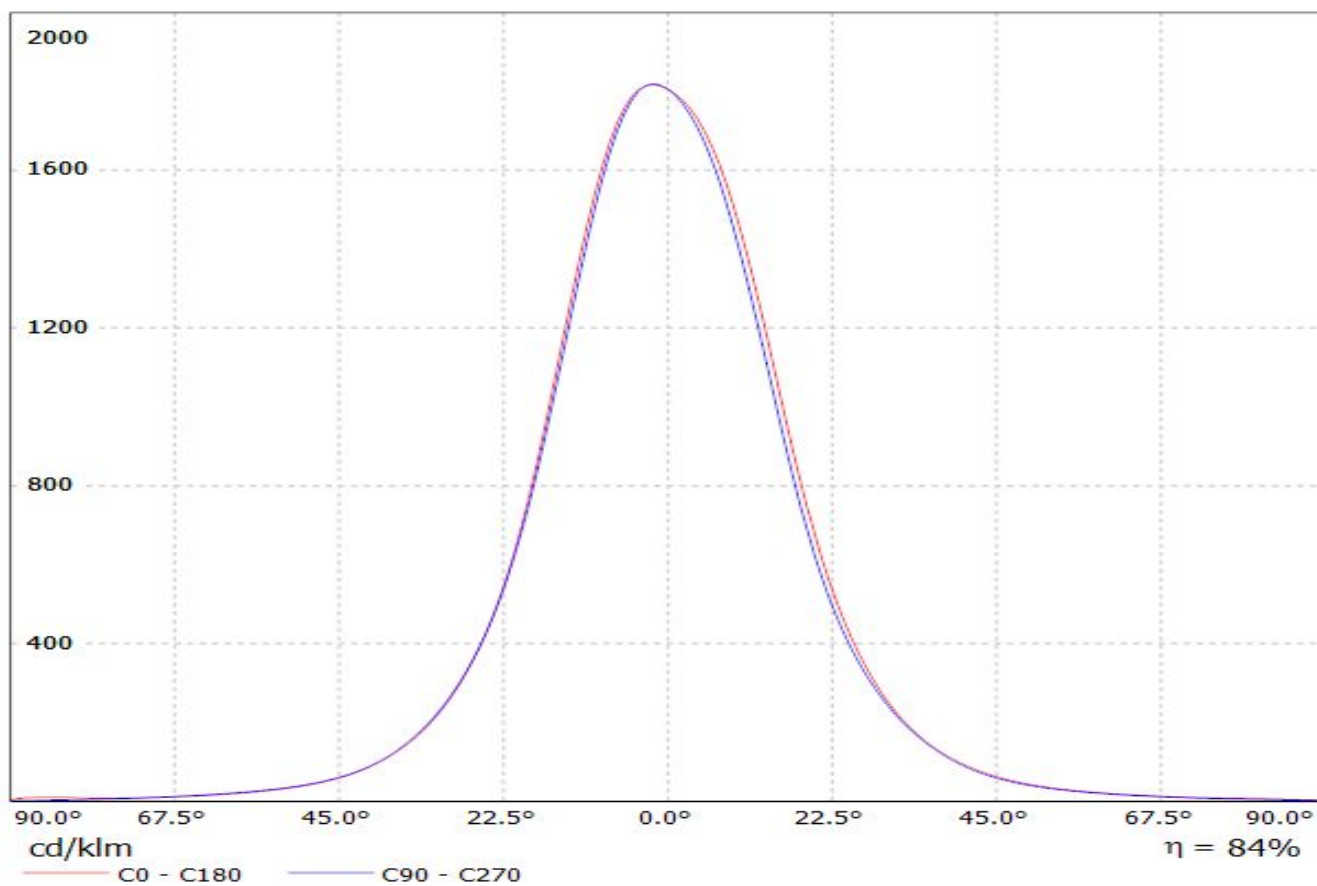

Luminaire: LEDIL OY CA11934_EMILY-W (Osram Oslon SSL 80°) Efficiency=86%
Lamps: 1 x Osram Oslon SSL 80° (85lm@250mA)

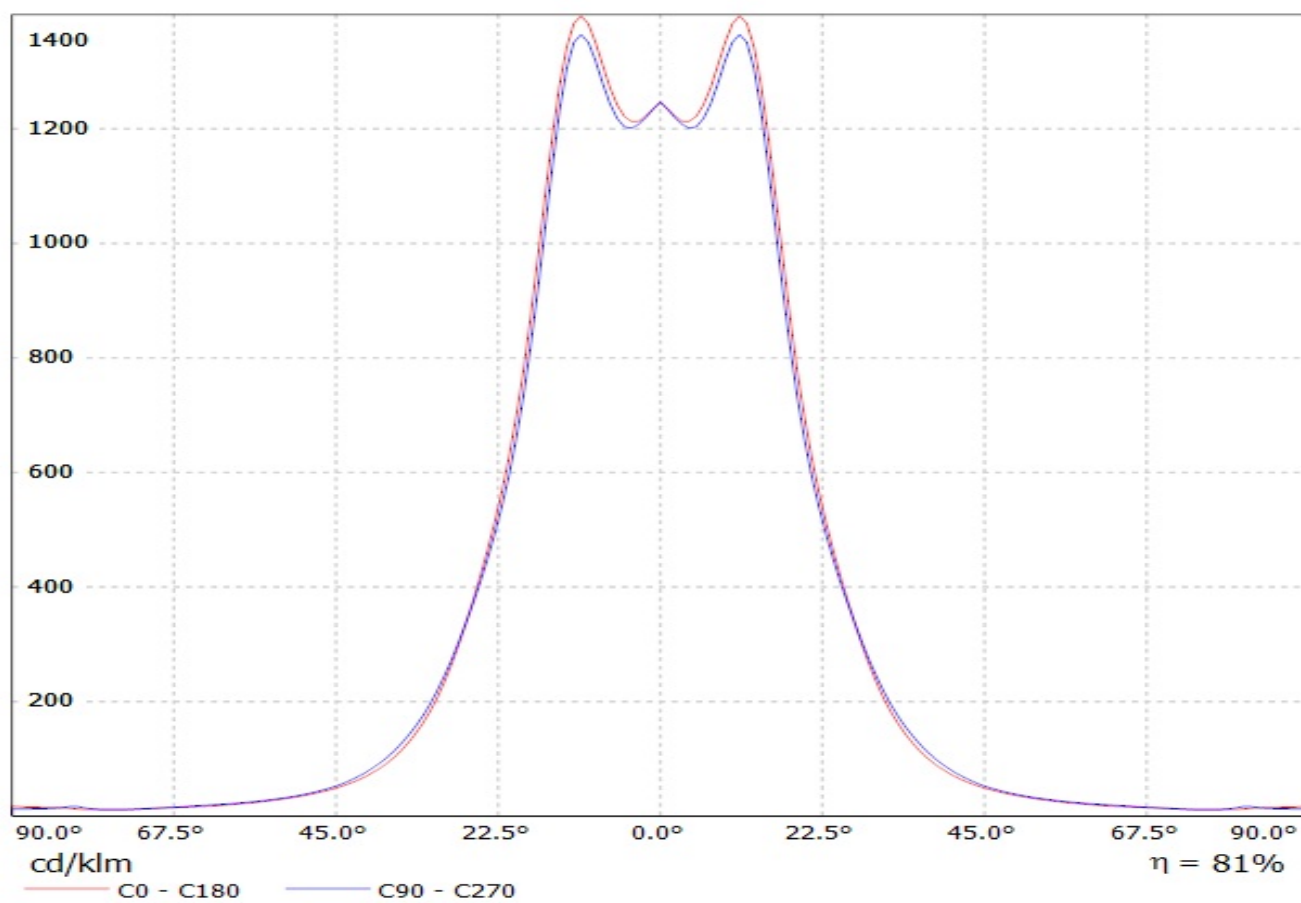

Luminaire: Ledil Oy CA11389-EMILY-O (Osram Square EC 62lm @ 250mA) Efficiency=87%

Lamps: 1 x Osram Square EC 62lm @ 250mA

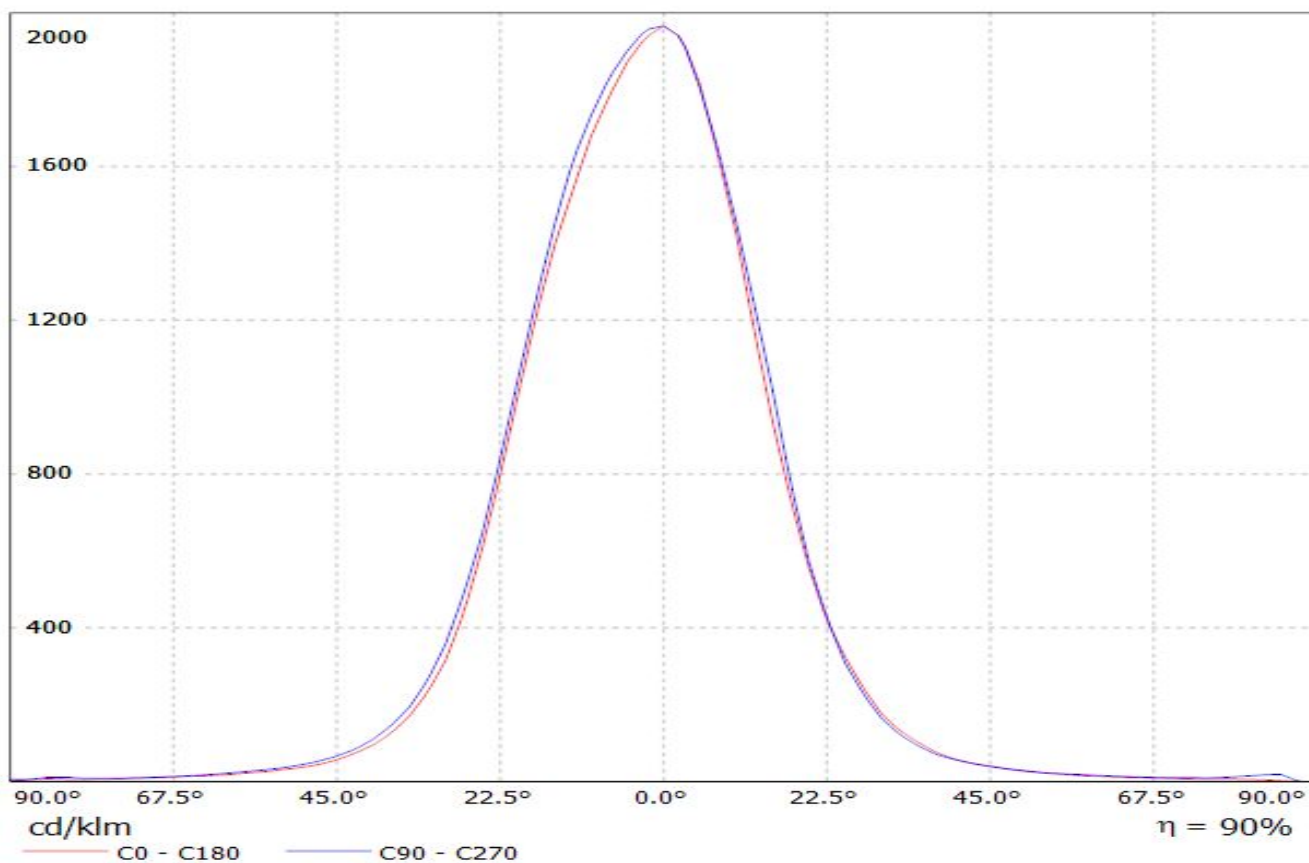

Luminaire: Ledil Oy CA11934_EMILY-W_(Oslon_Black_Flat)_SIMULATED
Lamps: 1 x Osram Oslon Black Flat (LUV HWQP)

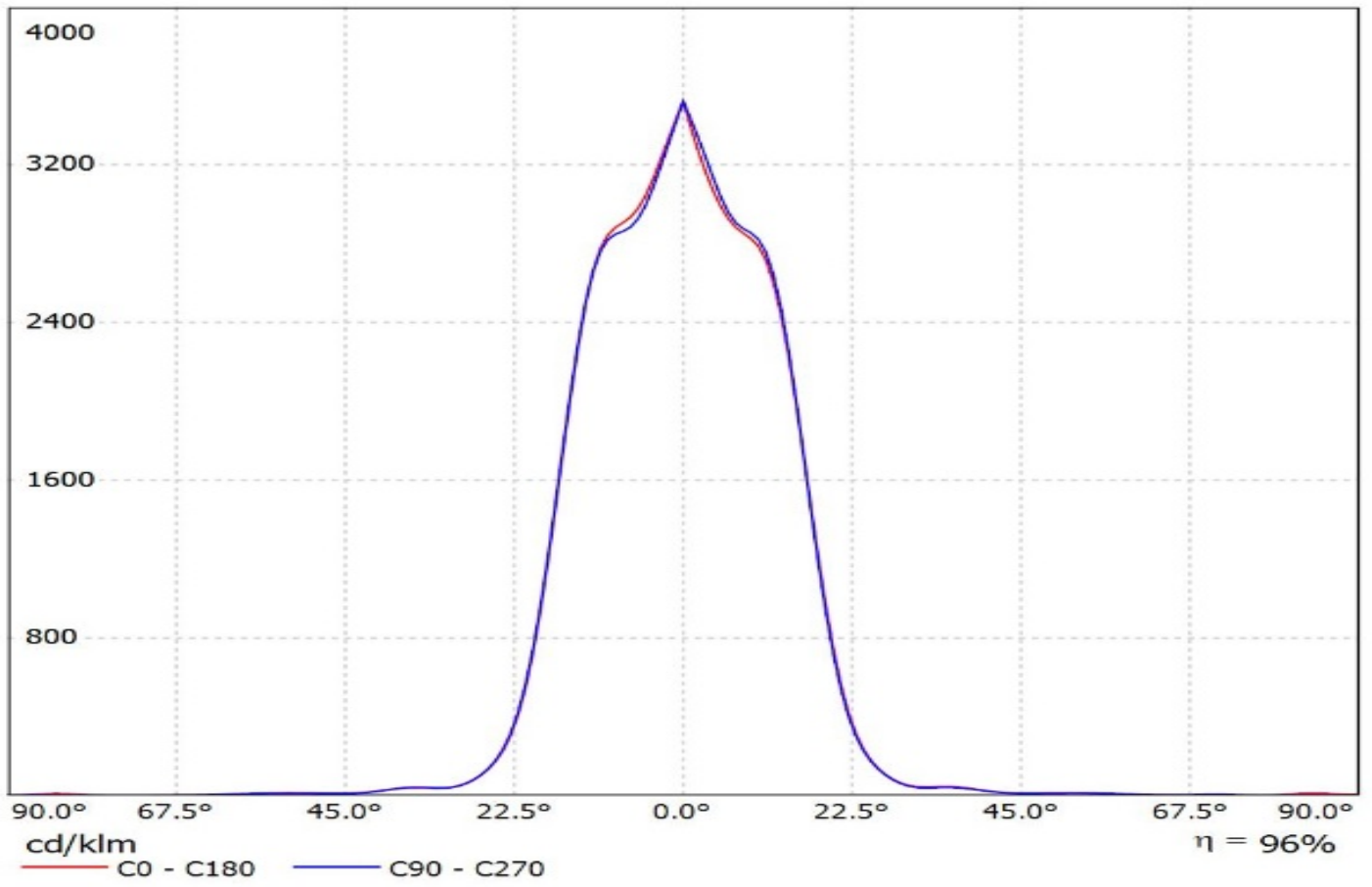

Luminaire: Ledil Oy CA11934_EMILY-W_(LH351B) Efficiency=88%
Lamps: 1 x Samsung LH351B 106lm @ 250mA CCT= P=0.72W I=250mA

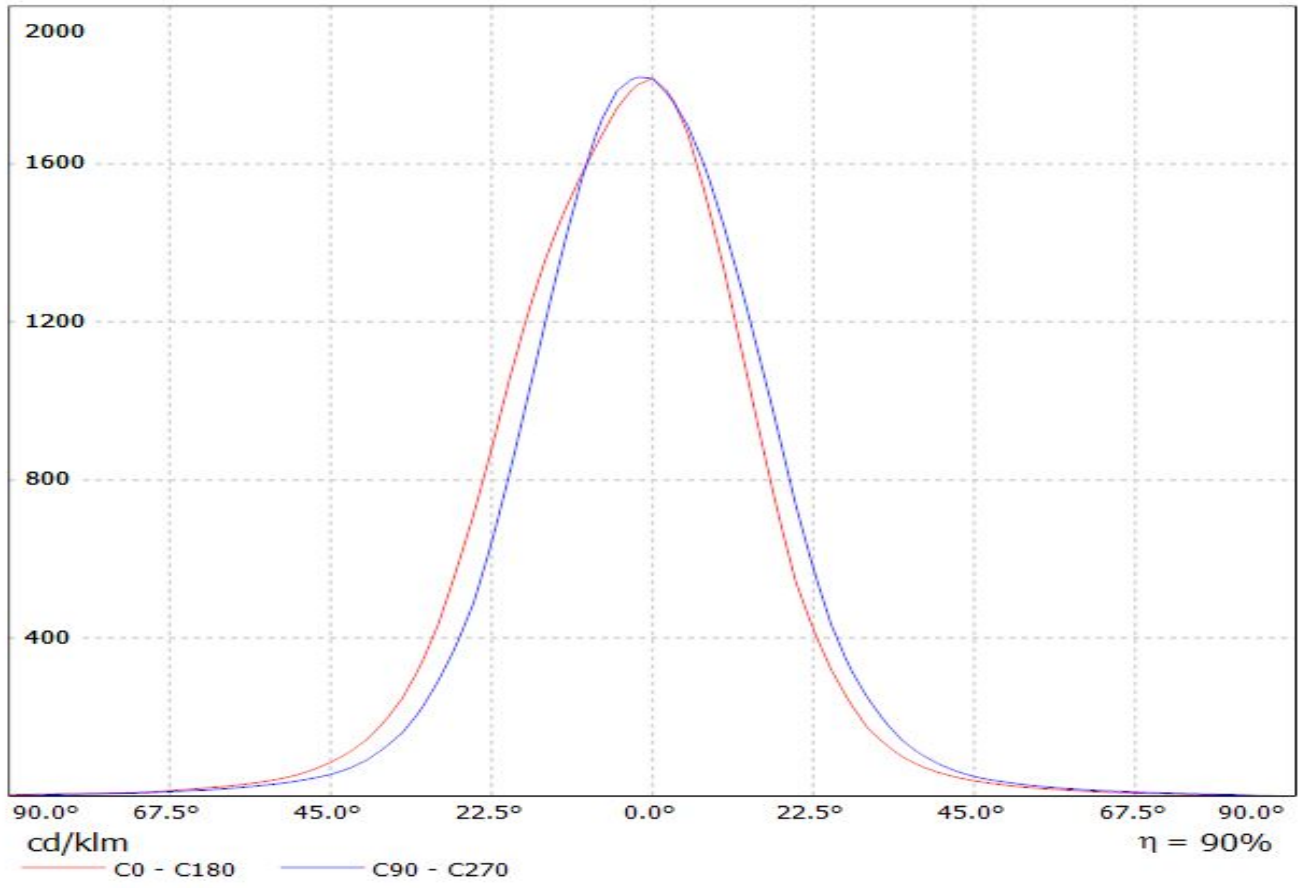

Luminaire: Ledil Oy CA11934_EMILY-W_(LH351Z) Efficiency=85%
Lamps: 1 x Samsung LH351Z (90.14lm @ 250mA) CCT=6500K P=0.7W I=250mA

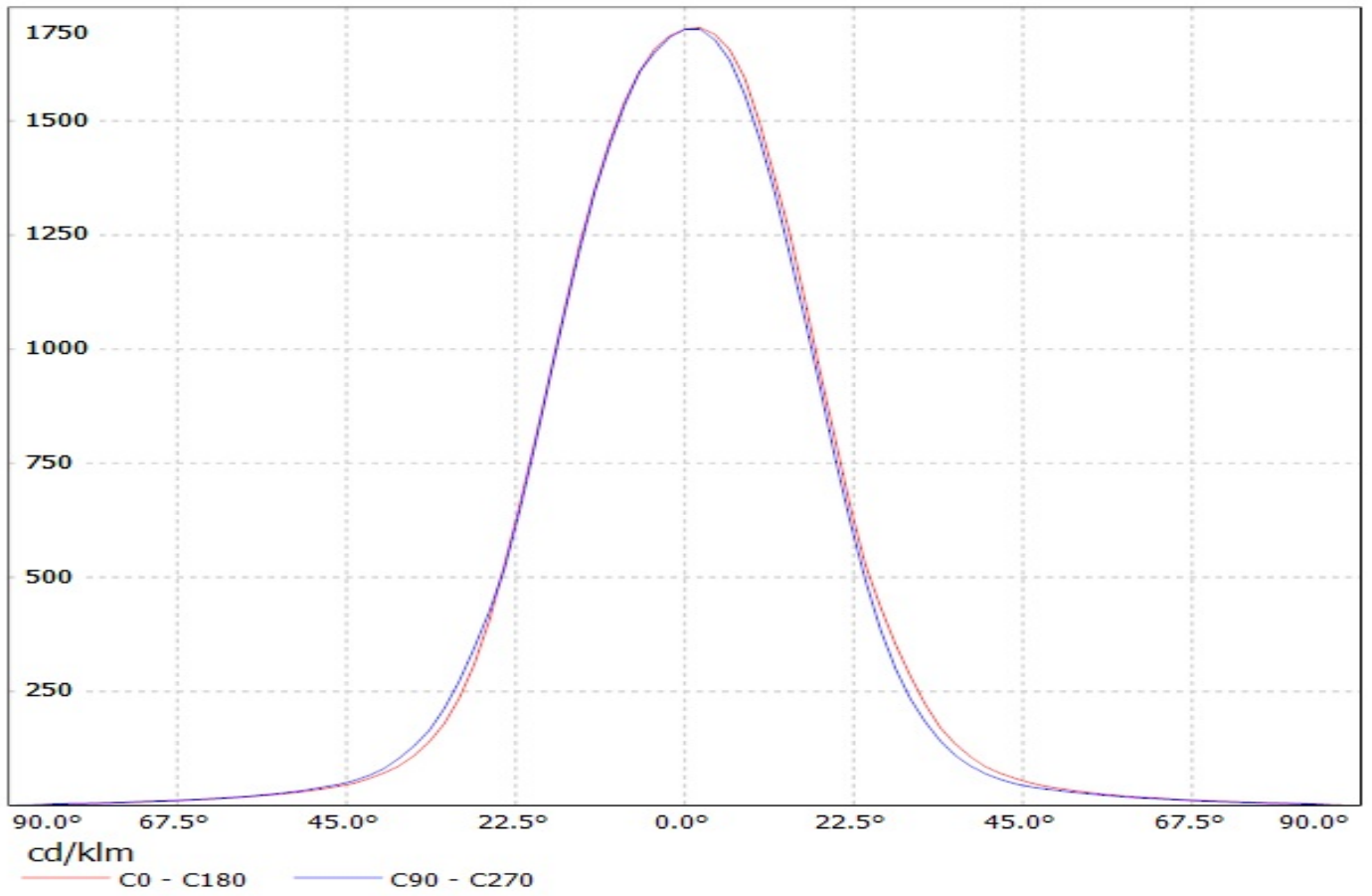

Luminaire: Ledil CA11934_EMILY-W_(Z8Y22P)

Lamps: 1 x Seoul_Z8Y22P_(W6E2G)_129.545lm@250mA_P=0.711175W_I=0.25A

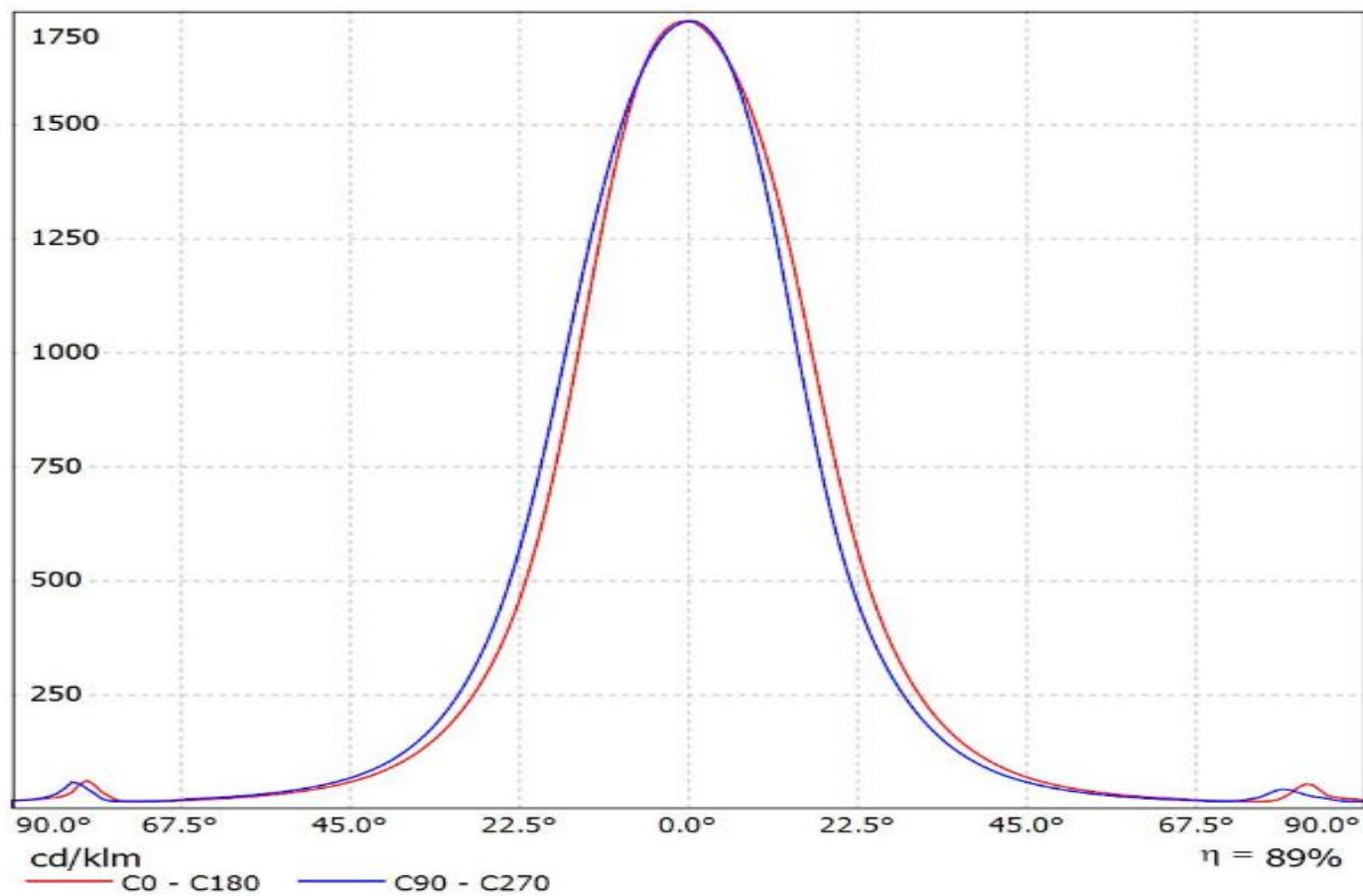

Luminaire: LEDiL Oy CA11934_EMILY-W_(XP-G2) Eff.84%
Lamps: 1 x Cree XP-G2 (98lm@250mA)

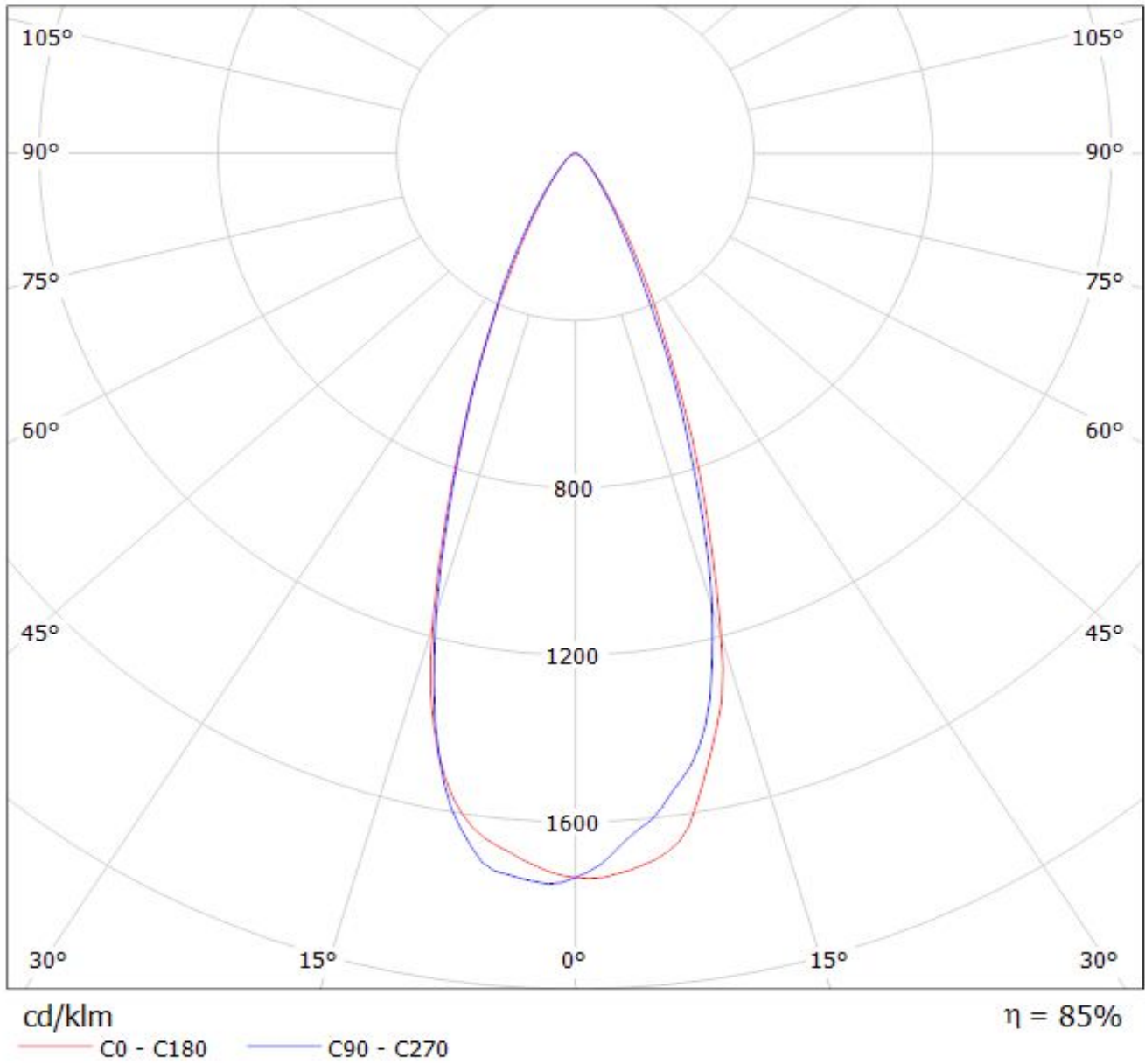

Luminaire: LEDil Oy CA11934_EMILY-W_(XP-E2)

Lamps: 1 x Cree XP-E2 (XPEBWT-L1-7B4-Q4-0-01) 78.62lm @ 250mA P=0.8W I=250mA

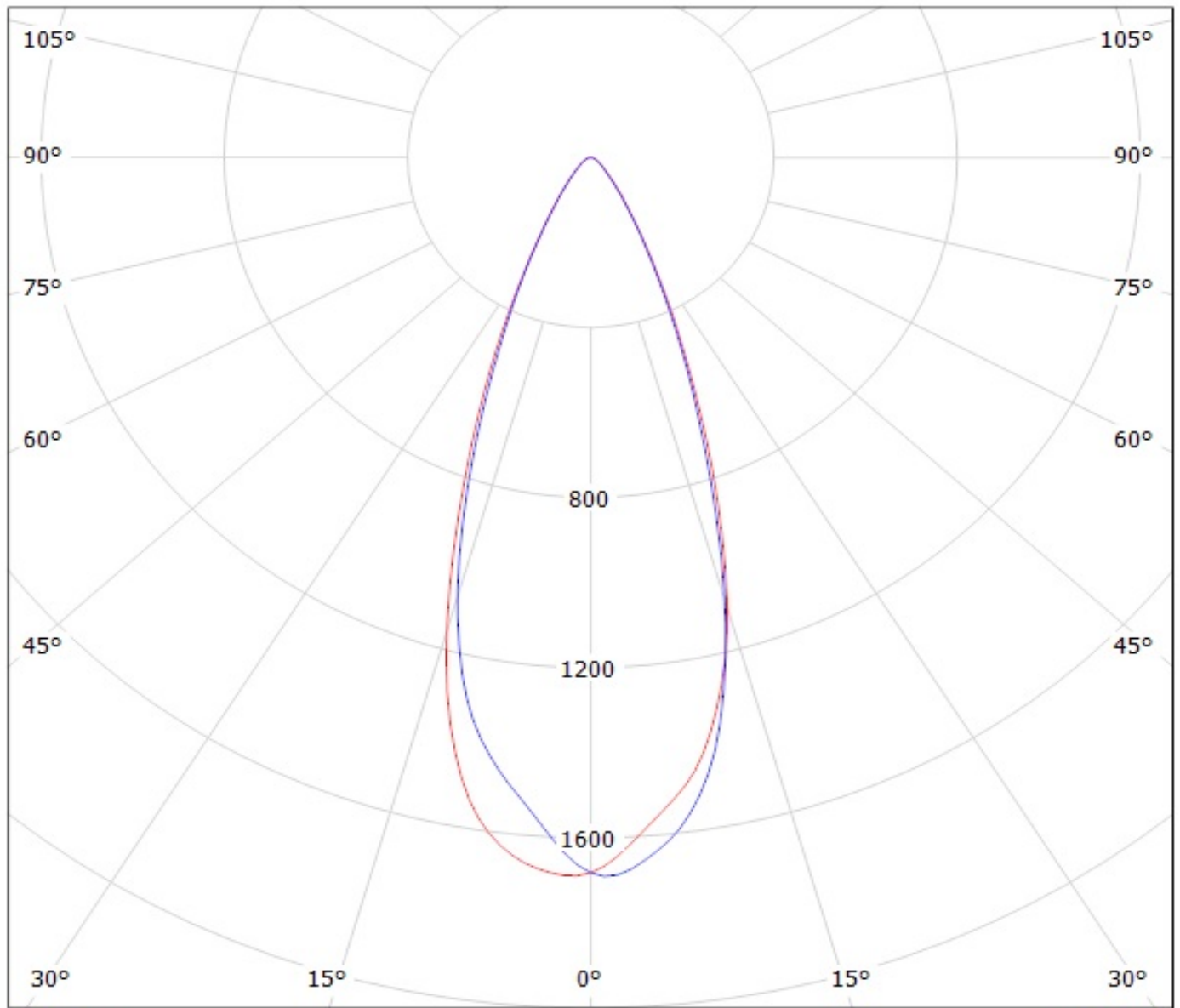

cd/klm

— C0 - C180 — C90 - C270

$\eta = 84\%$

Luminaire: LEDil Oy CA11934_EMILY-W_(XM-L2) Efficiency=86%

Lamps: 1 x Cree XM-L2 (XMLBWT-0-7B4-T30-0L-0001) 91lm @ 250mA CCT=3200K P=0.7W I=250mA

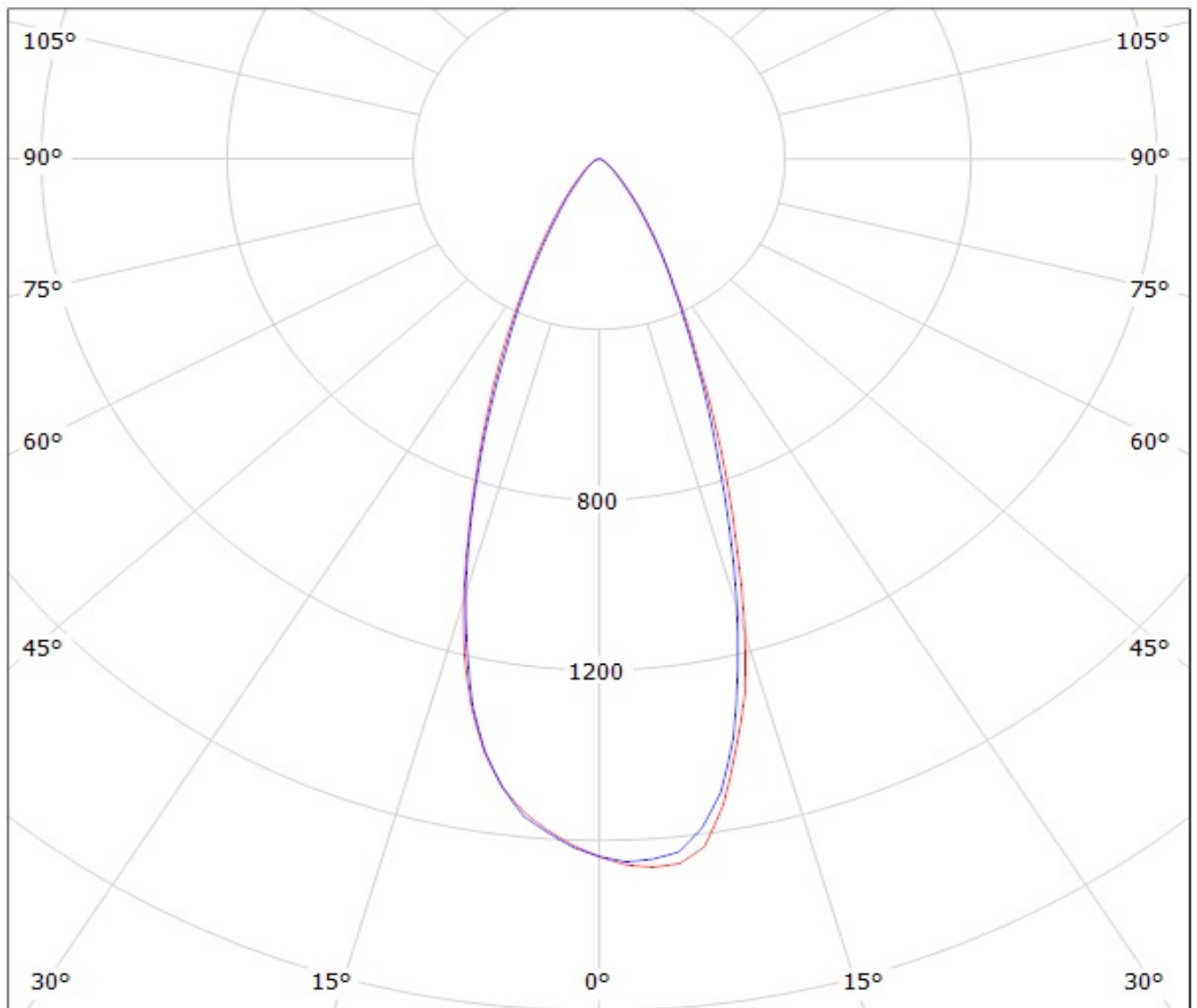

cd/klm

— C0 - C180

— C90 - C270

$\eta = 87\%$

Luminaire: Ledil Oy CA11934_EMILY-W_(XP-L) Efficiency= 87%
Lamps: 1 x Cree XP-L 125lm @ 250mA CCT= P=0.72W I=250mA

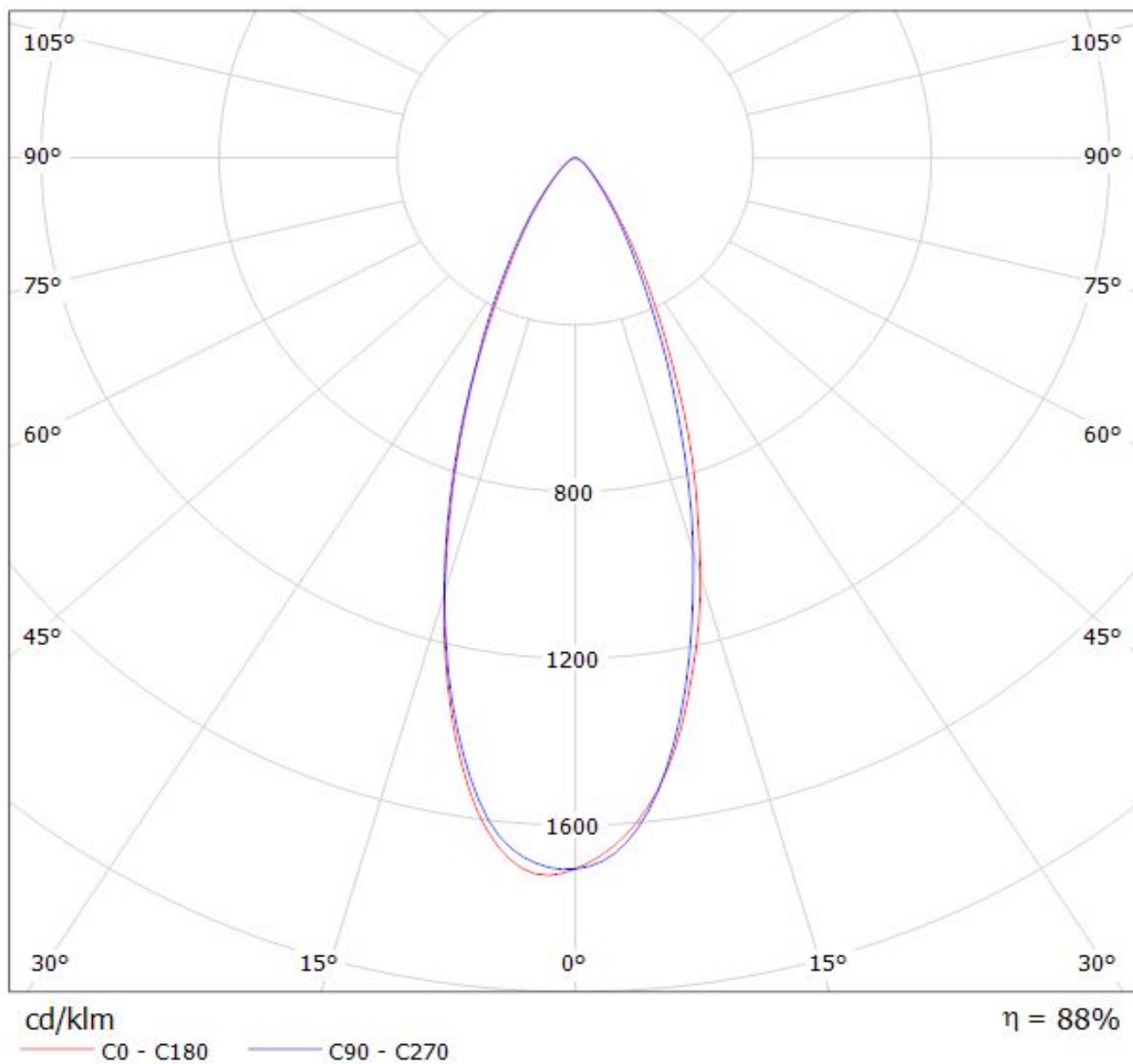

Luminaire: LEDiL Oy CA11934_EMILY-W_(XP-L_HI)

Lamps: 1 x Cree_XP-L_HI_114.406lm@250mA_P=0.745352W_I=0.2499A

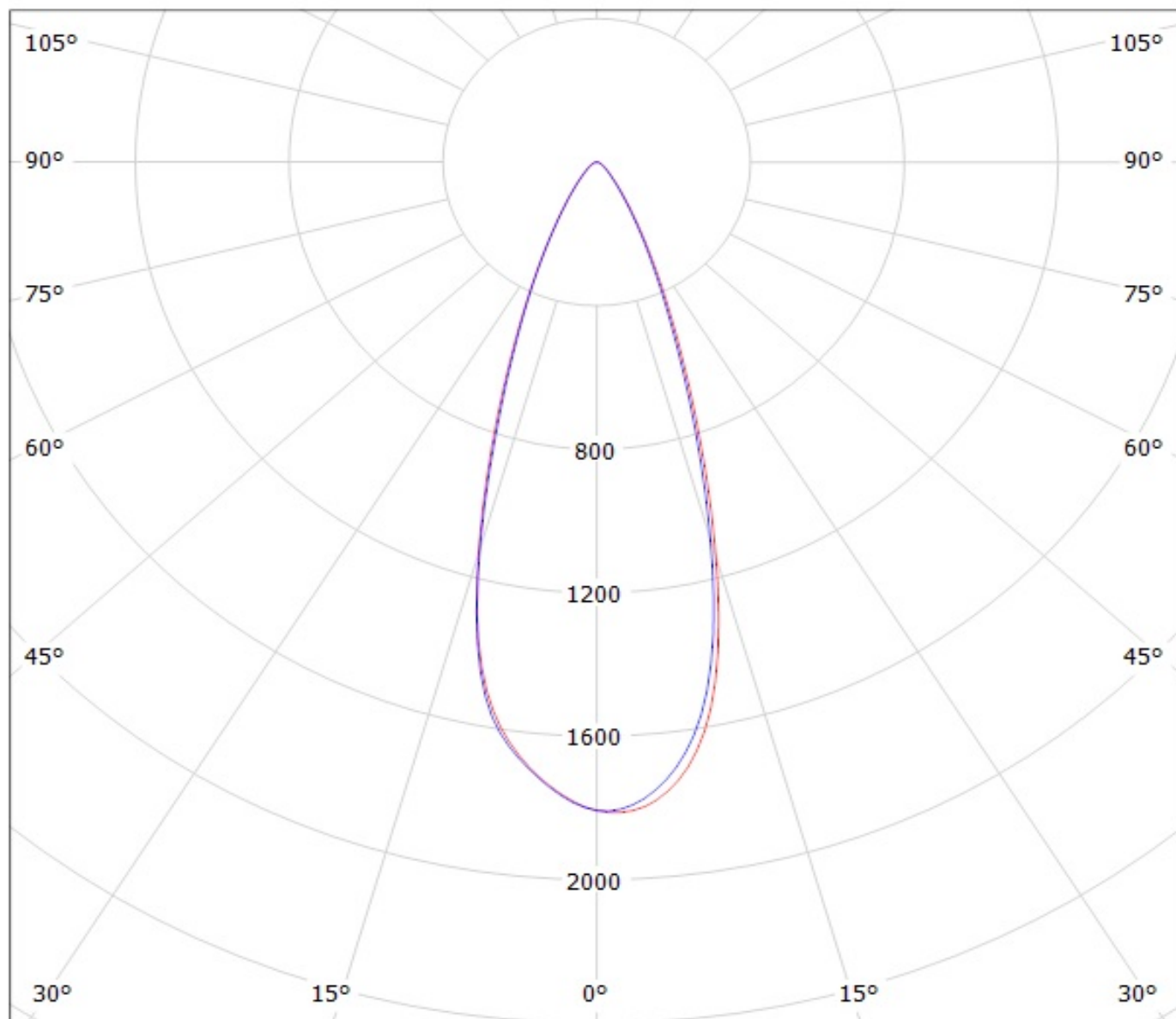

cd/klm

— C0 - C180

— C90 - C270

$\eta = 86\%$

Luminaire: LEDiL Oy
Lamps: 1 x CA11934_EMILY-W_(XHP35)

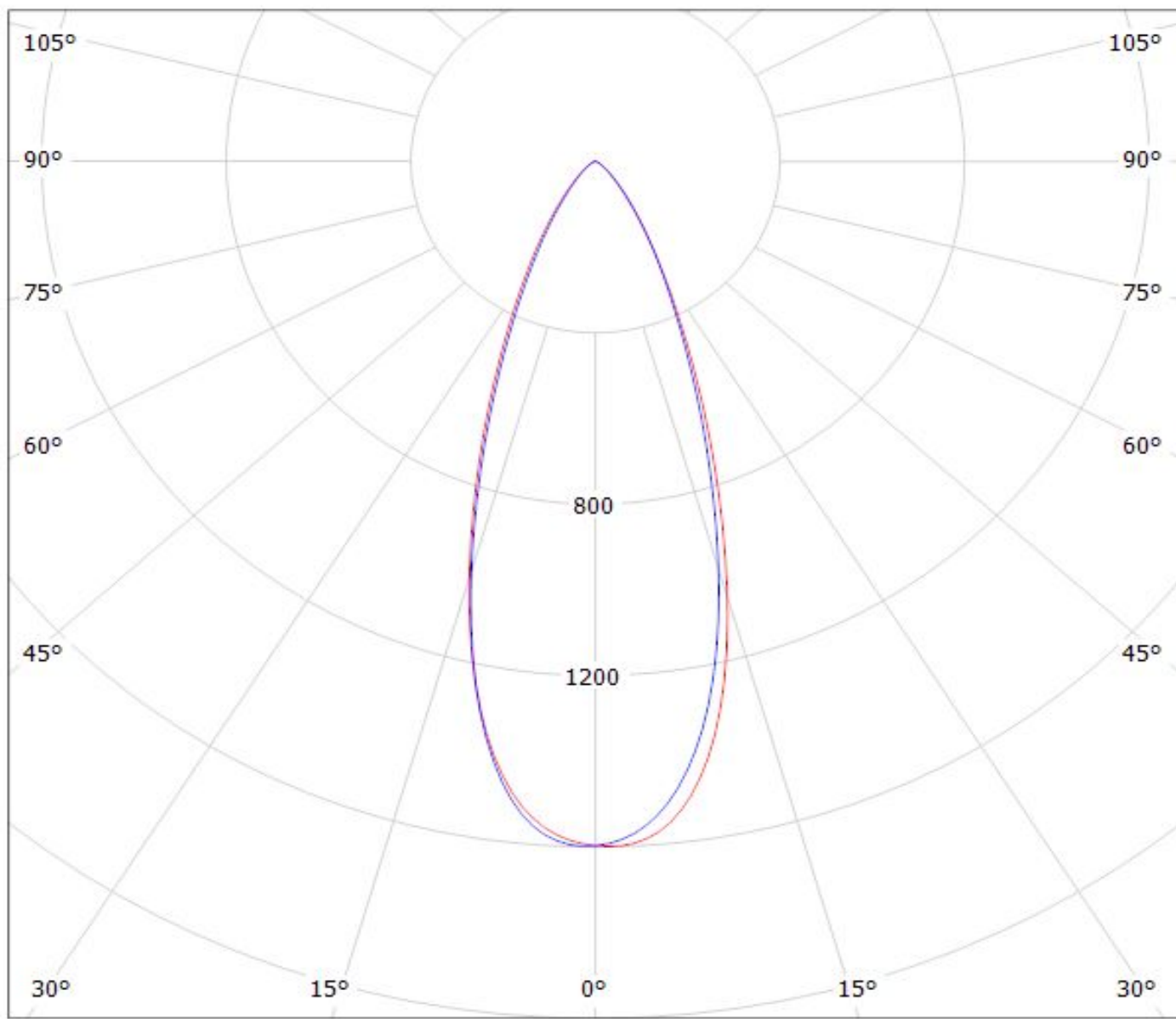

cd/klm

— C0 - C180 — C90 - C270

$\eta = 83\%$

Luminaire: LEDiL Oy CA11934_EMILY-W_(NS9x383) Eff.84,3%
Lamps: 1 x Nichia NS9x383 (105lm@250mA)

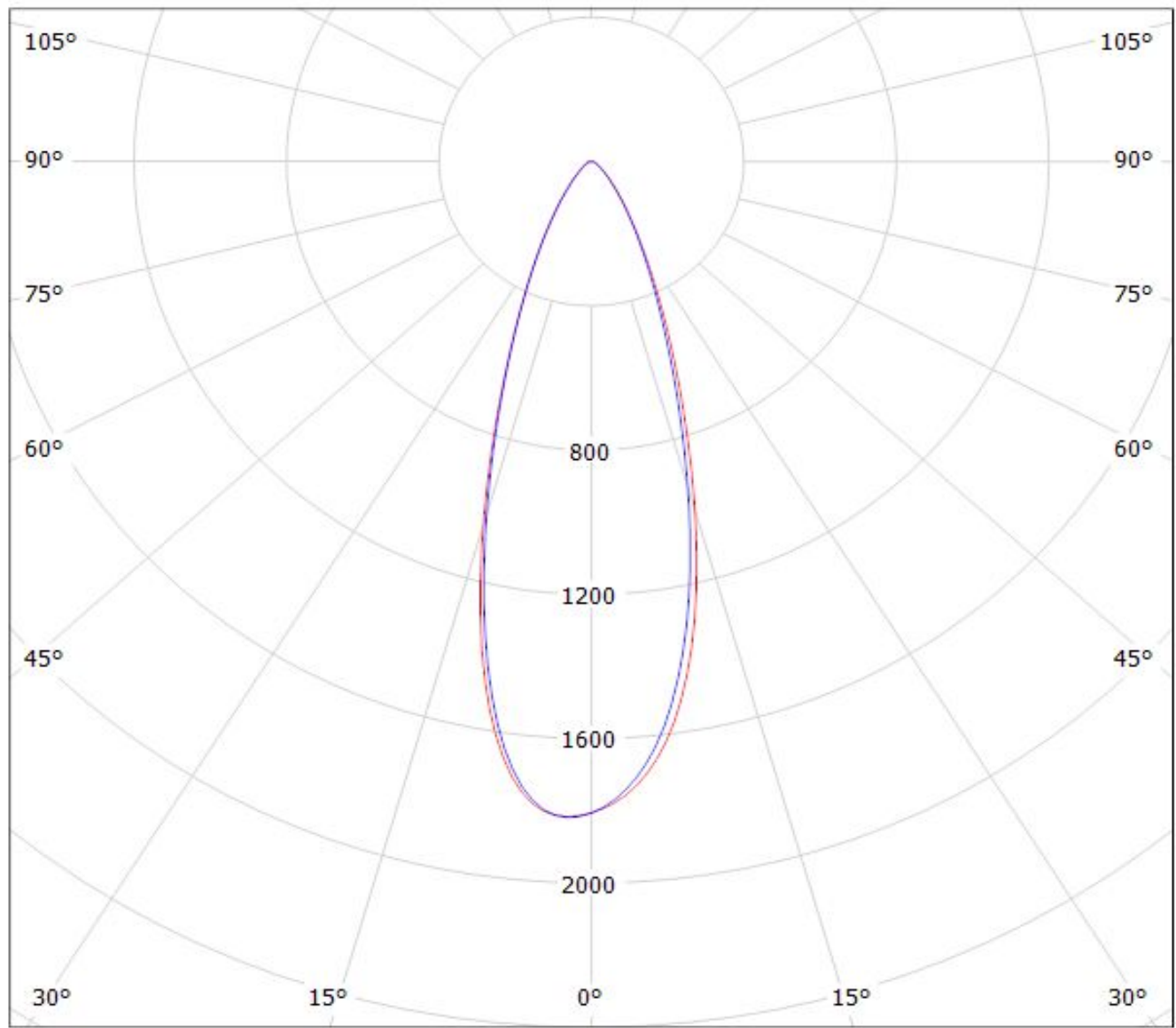

cd/klm
— C0 - C180 — C90 - C270

$\eta = 84\%$

Luminaire: LEDIL OY CA11934_EMILY-W (Osram Oslon SSL 80°) Efficiency=86%
Lamps: 1 x Osram Oslon SSL 80° (85lm@250mA)

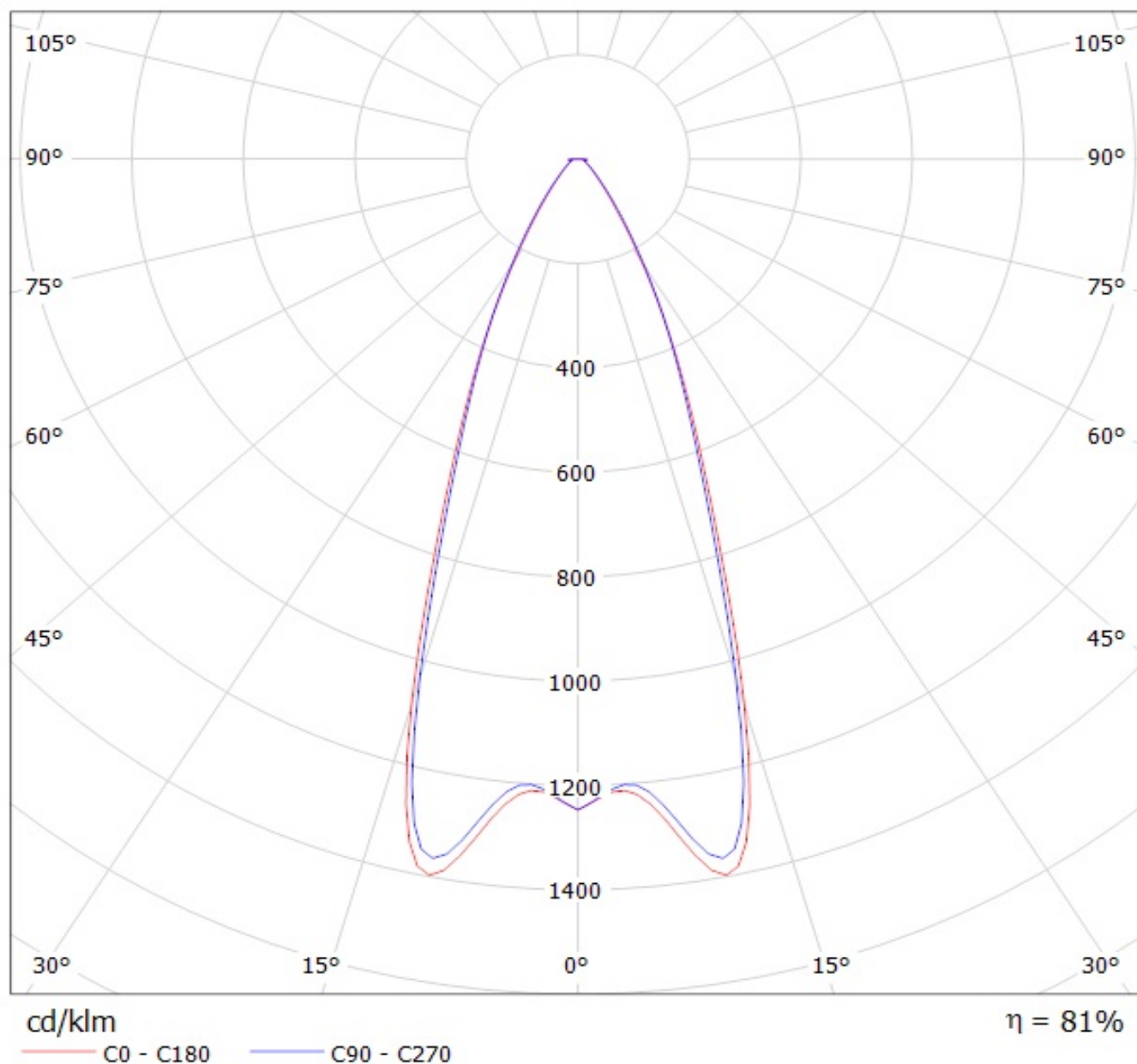

Luminaire: Ledil Oy CA11389-EMILY-O (Osram Square EC 62lm @ 250mA) Efficiency=87%
Lamps: 1 x Osram Square EC 62lm @ 250mA

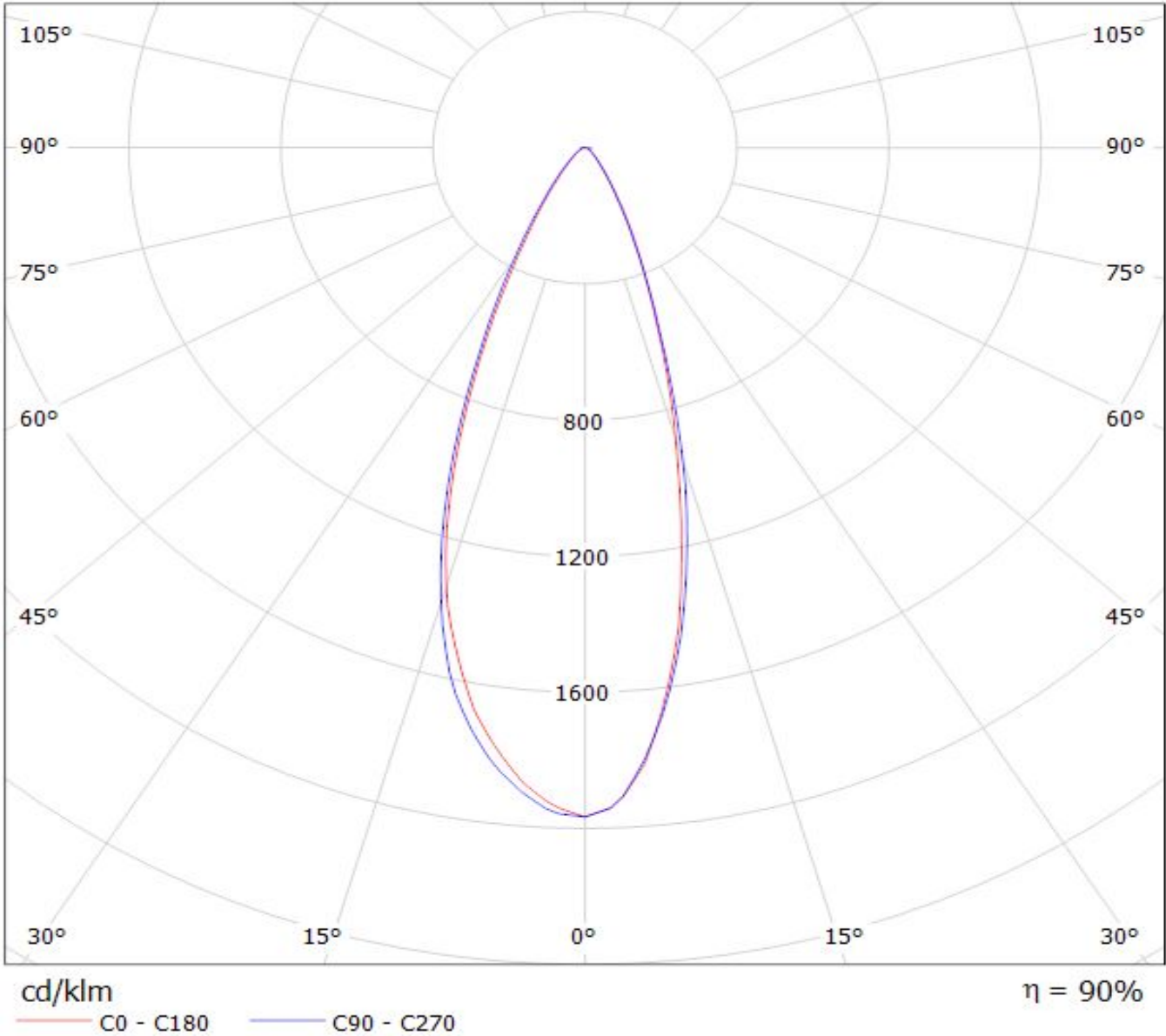

Luminaire: Ledil Oy CA11934_EMILY-W_(Oslon_Black_Flat)_SIMULATED
Lamps: 1 x Osram Oslon Black Flat (LUV HWQP)

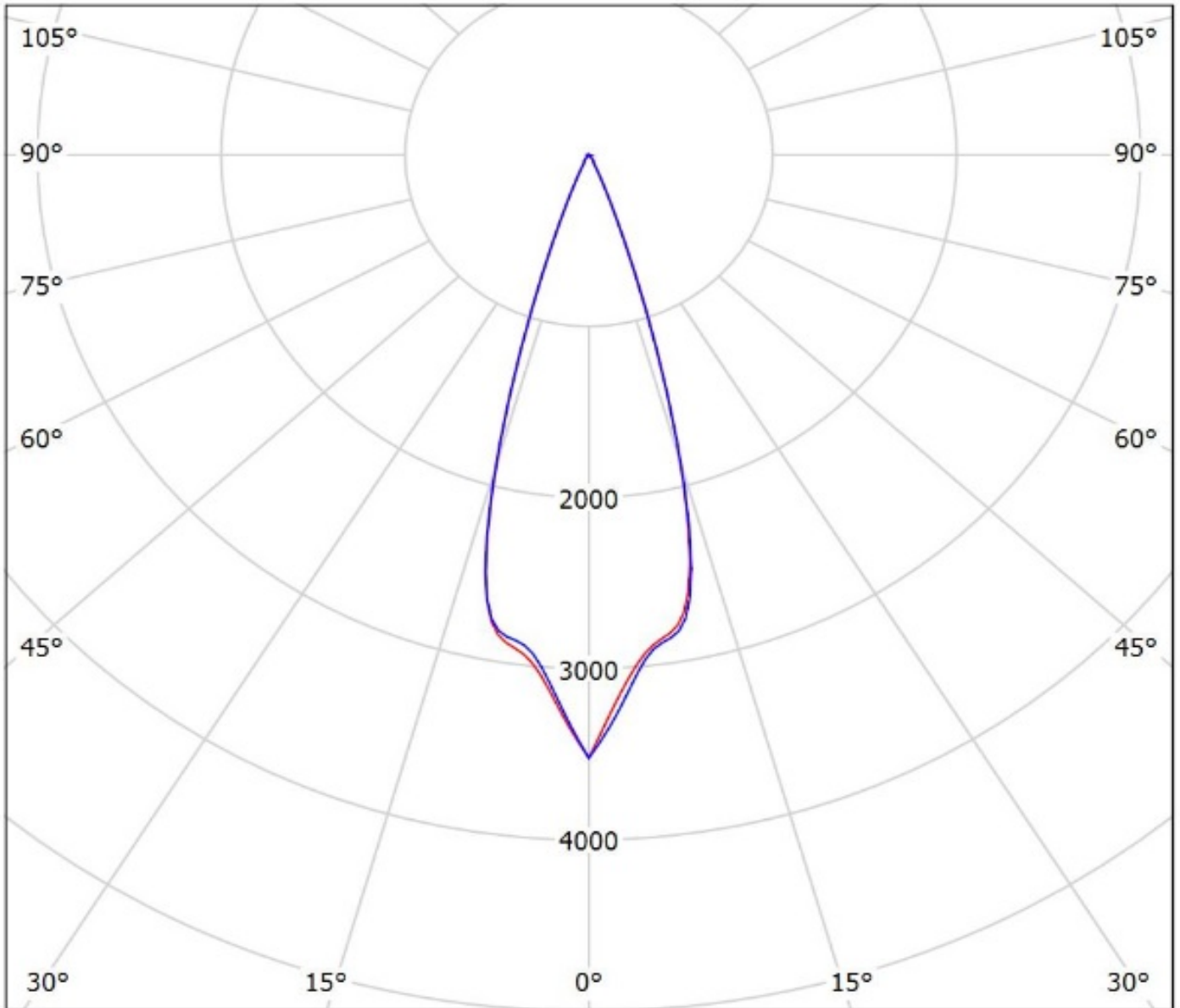

cd/klm

— C0 - C180 — C90 - C270

$\eta = 96\%$

Luminaire: Ledil Oy CA11934_EMILY-W_(LH351B) Efficiency=88%
Lamps: 1 x Samsung LH351B 106lm @ 250mA CCT= P=0.72W I=250mA

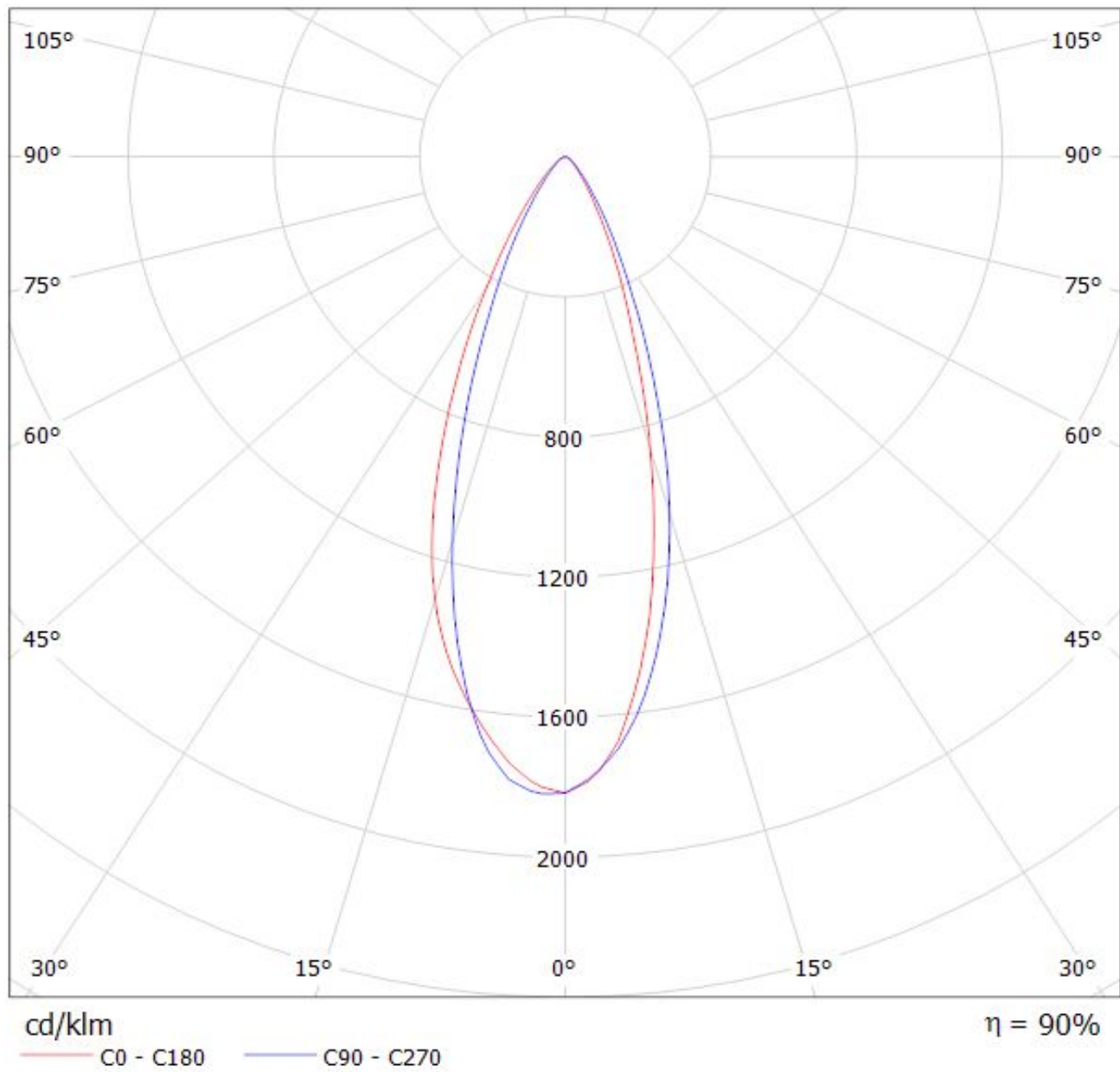

Luminaire: Ledil Oy CA11934_EMILY-W_(LH351Z) Efficiency=85%
Lamps: 1 x Samsung LH351Z (90.14lm @ 250mA) CCT=6500K P=0.7W I=250mA

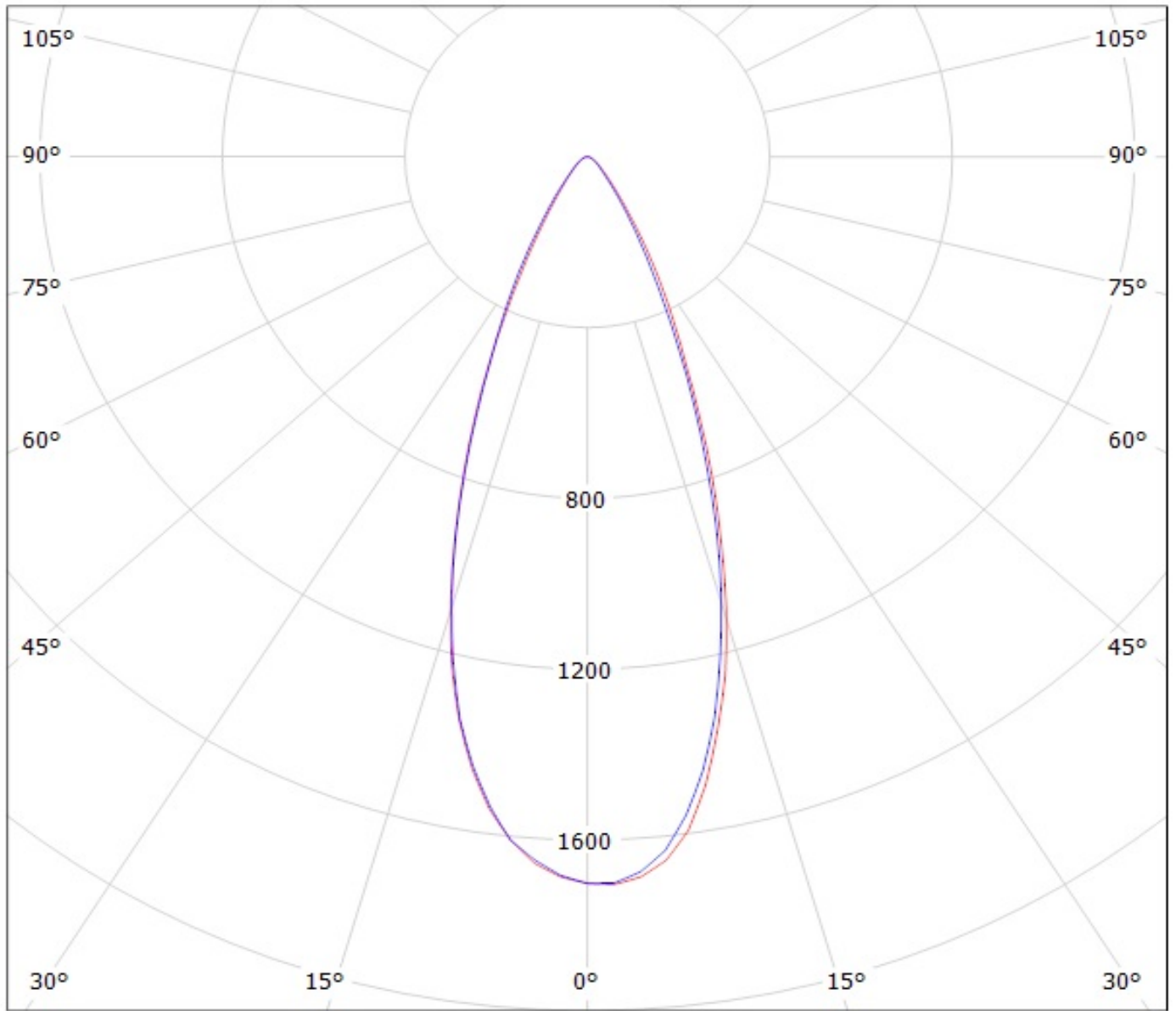

cd/klm

— C0 - C180

— C90 - C270

Luminaire: Ledil CA11934_EMILY-W_(Z8Y22P)

Lamps: 1 x Seoul_Z8Y22P_(W6E2G)_129.545lm@250mA_P=0.711175W_I=0.25A

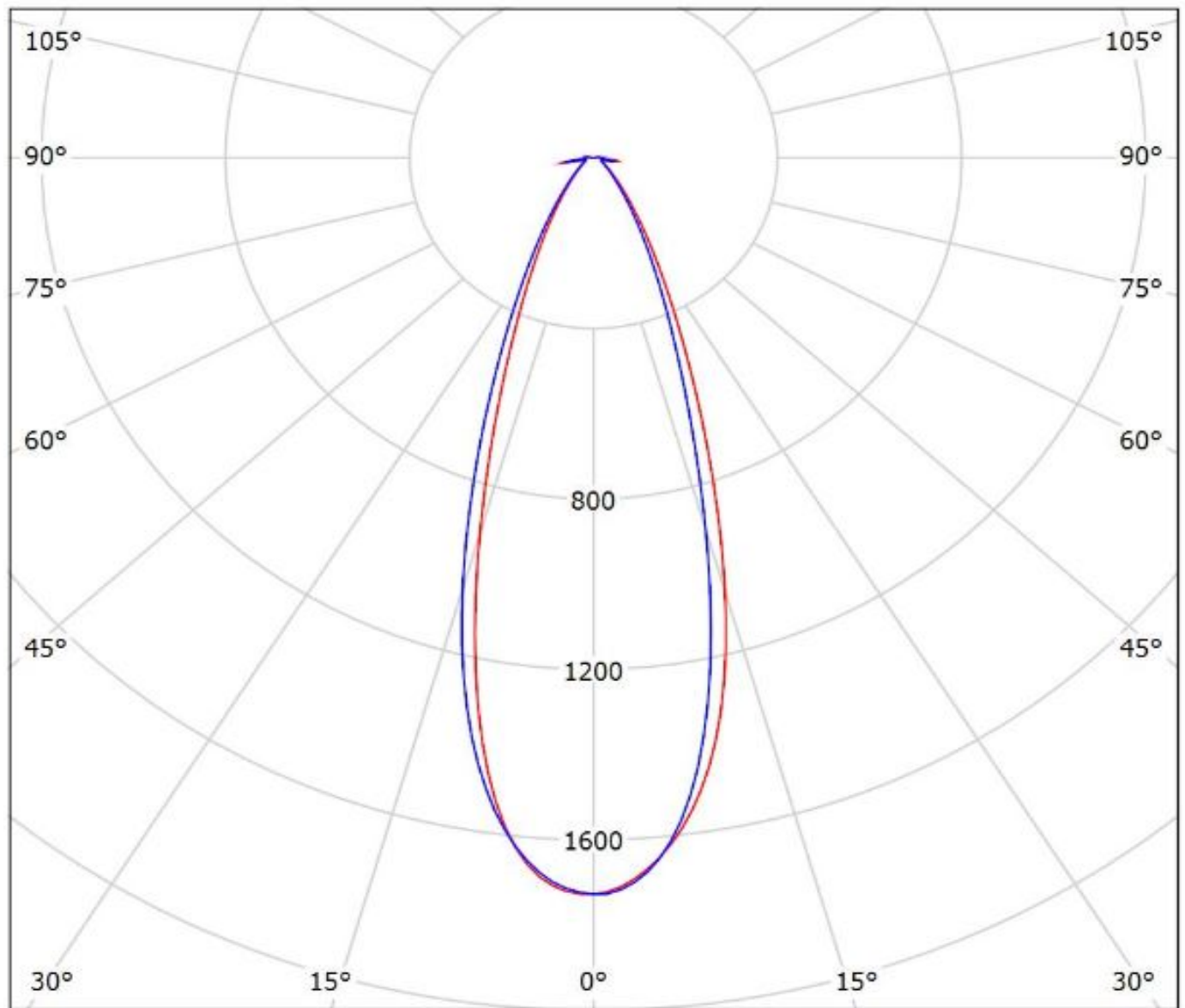

cd/klm

— C0 - C180 — C90 - C270

η = 89%

NOTE: The typical divergence will be changed by different color, chip size and chip position tolerance. The typical total divergence is the full angle measured where the luminous intensity is half of the peak value.