

## Data sheet

Commercial Art.No.: 25.350.3453.0

PCB pin header 8213 S / 4 G OB

PCB pin header, connection method depends on used socket part , 4 poles, pitch:  
5.08 mm, type of packing: carton, color: grey



Commercial Art.No.	25.350.3453.0
EAN	4015573192676
Order Unit	50

Certificates / Approvals



## Technical data

### General

Modular spacing	5.08 mm
Soldering process	Wave soldering
Packaging	Carton
Number of poles	4
Number of levels	1
Marking	No
Fastening	None
Mating direction towards (circuit) board	90°

### Technical data

Rated current	12 A
Overvoltage Category I	1000 V
Overvoltage Category II	400 V
Overvoltage Category III	250 V
Rated impulse voltage	4 kV

### Technical Data UL/CSA

Voltage UL	300 V
Current field wiring	15 A
Current factory wiring	15 A
Voltage CSA	300 V
Current CSA	15 A

### Other

Type of insulation material	Thermoplastic
Color	Grey
Height	12 mm

Length	21.72 mm
Depth	8.4 mm
Material contact base	CuZn
Material contact surface	Sn

#### Classification

ECLASS 11	
ECLASS 8.1	27440402
ETIM 7.0	EC002637
ETIM 6.0	EC002637
ETIM 5.0	EC002637
ETIM 4.0	EC002637

#### Product compliance

ROHS conformity status	Compliant
REACH-SVHC conformity status	Compliant

#### Fits with

Commercial Art.No.:	Article-type description:	Description:
25.240.3453.0	PCB connector 8213 B / 4 TOP OB	PCB female connector with front/top screw connection, 4 poles, max. cross section: 2.5 mm <sup>2</sup> , pitch: 5.08 mm, type of packing: carton, color: grey
25.240.0453.0	PCB connector 8213 B / 4 TOP	PCB female connector with front/top screw connection, 4 poles, printed version, max. cross section: 2.5 mm <sup>2</sup> , pitch: 5.08 mm, type of packing: carton, color: grey
25.340.3453.0	PCB connector 8213 B / 4 OB	PCB female connector with screw connection with rising cage clamp system, 4 poles, max. cross section: 2.5 mm <sup>2</sup> , pitch: 5.08 mm, type of packing: carton, color: grey
25.340.0453.0	PCB connector 8213 B / 4	PCB female connector with screw connection with rising cage clamp system, 4 poles, printed version, max. cross section: 2.5 mm <sup>2</sup> , pitch: 5.08 mm, type of packing: carton, color: grey
25.345.3453.0	PCB connector 8213 B / 4 VR OB	PCB female connector with screw connection with rising cage clamp system, 4 poles, max. cross section: 2.5 mm <sup>2</sup> , pitch: 5.08 mm, type of packing: carton, color: grey
25.345.0453.0	PCB connector 8213 B / 4 VR	PCB female connector with screw connection with rising cage clamp system, 4 poles, printed version, max. cross section: 2.5 mm <sup>2</sup> , pitch: 5.08 mm, type of packing: carton, color: grey
25.346.3453.0	PCB connector 8213 B / 4 VL OB	PCB female connector with screw connection with rising cage clamp system, 4 poles, max. cross section: 2.5 mm <sup>2</sup> , pitch: 5.08 mm, type of packing: carton, color: grey
25.346.0453.0	PCB connector 8213 B / 4 VL	PCB female connector with screw connection with rising cage clamp system, 4 poles, printed version, max. cross section: 2.5 mm <sup>2</sup> , pitch: 5.08 mm, type of packing: carton, color: grey
27.341.3453.0	PCB connector 8213 B / 4 S OB	PCB female connector, 4 poles, pitch: 5.08 mm, type of packing: carton, color: grey
25.840.3453.0	PCB connector 8213 BFK / 4 TOP OB	PCB female connector with tension spring connection, 4 poles, max. cross section: 2.5 mm <sup>2</sup> , pitch: 5.08 mm, type of packing: carton, color: grey
25.840.0453.0	PCB connector 8213 BFK / 4 TOP	PCB female connector with tension spring connection, 4 poles, printed version, max. cross section: 2.5 mm <sup>2</sup> , pitch: 5.08 mm, type of packing: carton, color: grey

25.343.3453.0	PCB connector 8213 BL / 4 W OB	PCB female connector with pin header, connection method depends on usedsocket part , 4 poles, pitch: 5.08 mm, type of packing: carton, color: grey
25.343.0453.0	PCB connector 8213 BL / 4 W	PCB female connector with pin header, connection method depends on usedsocket part , 4 poles, printed version, pitch: 5.08 mm, type of packing: carton, color: grey
25.342.3453.0	PCB connector 8213 BL / 4 G OB	PCB female connector with pin header, connection method depends on usedsocket part , 4 poles, pitch: 5.08 mm, type of packing: carton, color: grey
25.342.0453.0	PCB connector 8213 BL / 4 G	PCB female connector with pin header, connection method depends on usedsocket part , 4 poles, printed version, pitch: 5.08 mm, type of packing: carton, color: grey

für folgende Tabellen-Zchnng.:  
25.350.3253.0 8213 S/...G

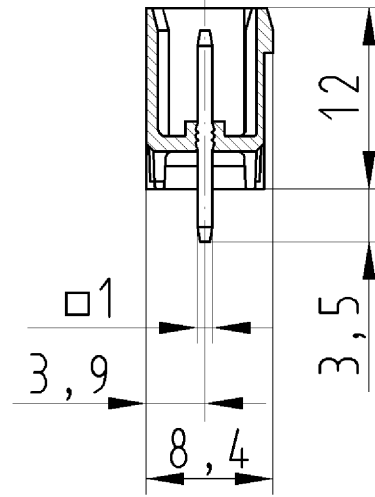
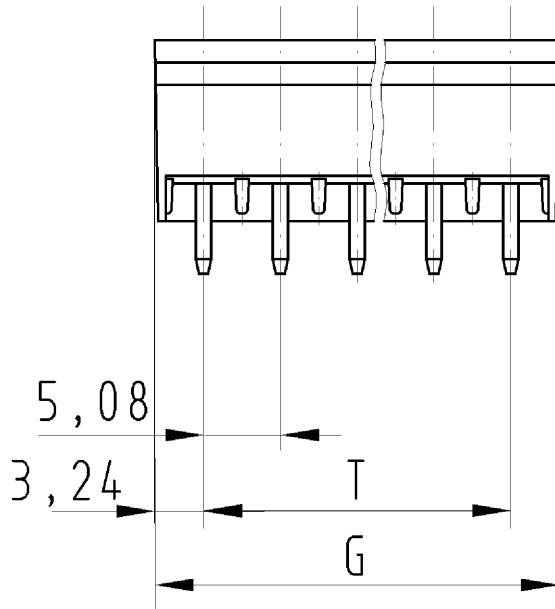

LP.STIFTLEISTE  
25.350.3253.0 10W  
19.10.2007 SCJ  
M 2:1